

SCIENCE AND TECHNOLOGY

STANDARD NINE

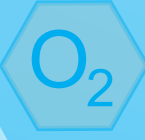
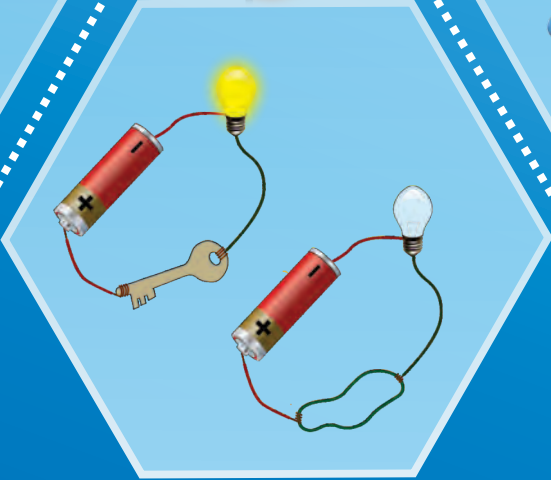
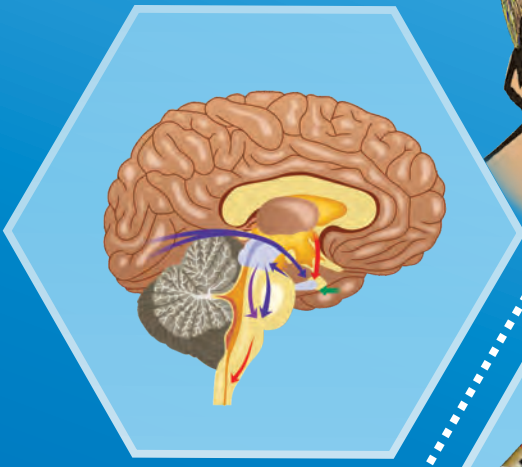
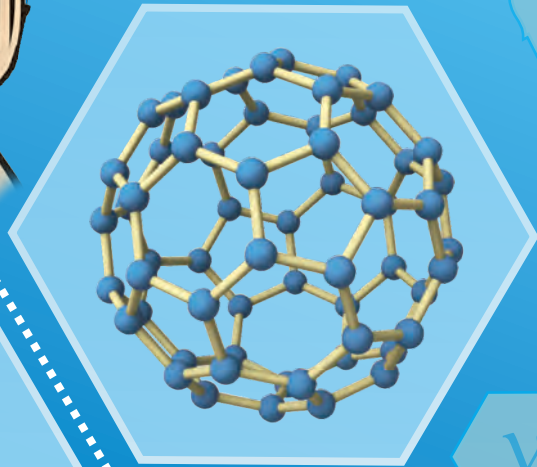
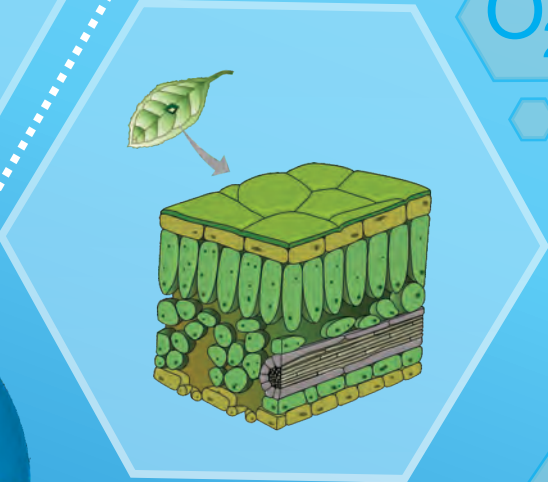
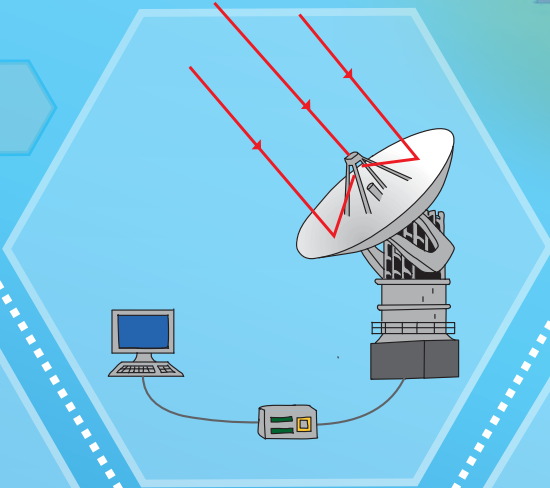

The Constitution of India

Chapter IV A

Fundamental Duties

ARTICLE 51A

Fundamental Duties- It shall be the duty of every citizen of India—

- (a) to abide by the Constitution and respect its ideals and institutions, the National Flag and the National Anthem;
- (b) to cherish and follow the noble ideals which inspired our national struggle for freedom;
- (c) to uphold and protect the sovereignty, unity and integrity of India;
- (d) to defend the country and render national service when called upon to do so;
- (e) to promote harmony and the spirit of common brotherhood amongst all the people of India transcending religious, linguistic and regional or sectional diversities, to renounce practices derogatory to the dignity of women;
- (f) to value and preserve the rich heritage of our composite culture;
- (g) to protect and improve the natural environment including forests, lakes, rivers and wild life and to have compassion for living creatures;
- (h) to develop the scientific temper, humanism and the spirit of inquiry and reform;
- (i) to safeguard public property and to abjure violence;
- (j) to strive towards excellence in all spheres of individual and collective activity so that the nation constantly rises to higher levels of endeavour and achievement;
- (k) who is a parent or guardian to provide opportunities for education to his child or, as the case may be, ward between the age of six and fourteen years.

The Coordination Committee formed by GR No. Abhyas - 2116/(Pra.Kra.43/16) SD - 4
Dated 25.4.2016 has given approval to prescribe this textbook in its meeting held on 3.3.2017

SCIENCE AND TECHNOLOGY

STANDARD NINE

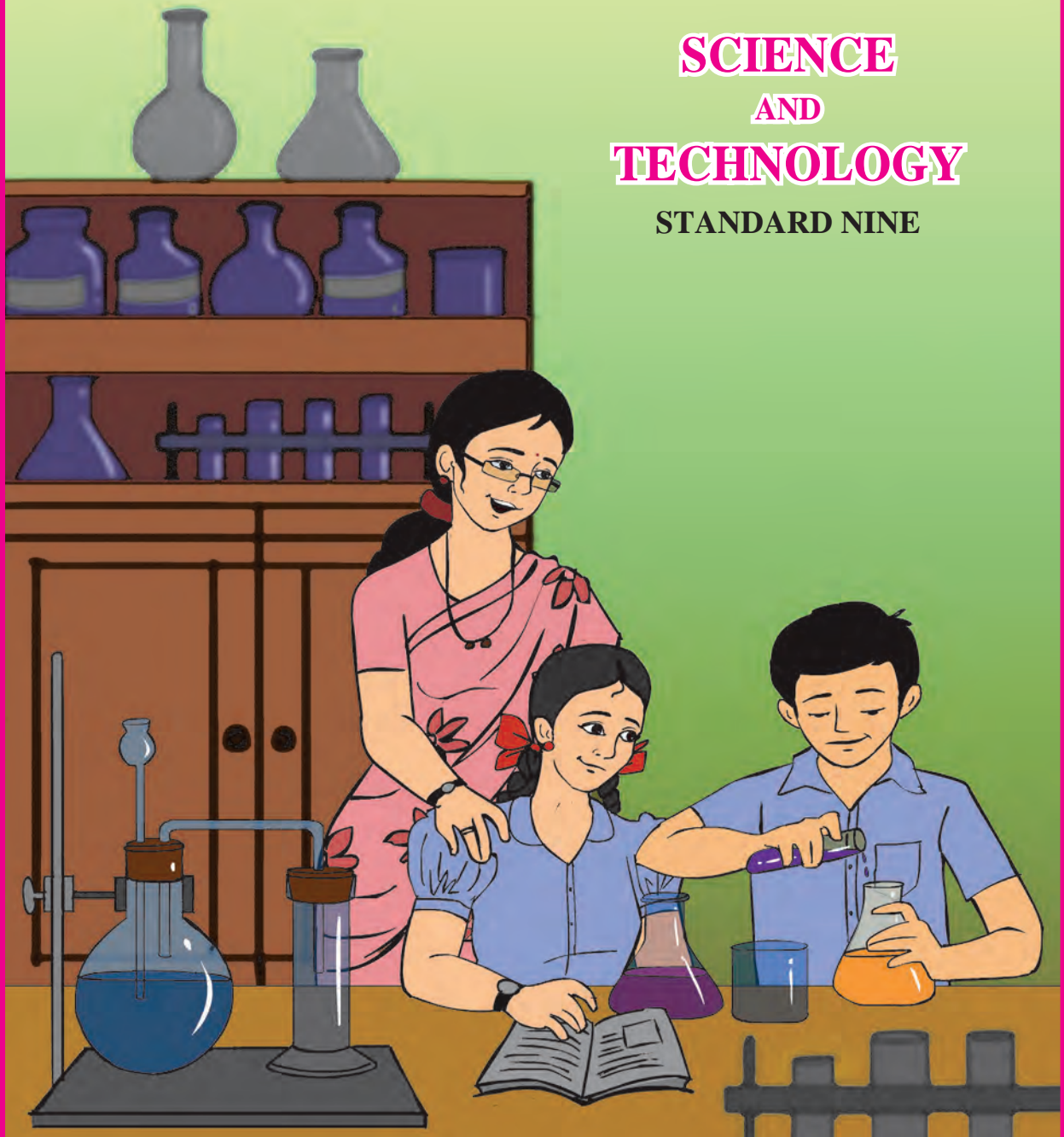

**Maharashtra State Bureau of Textbook Production and
Curriculum Research, Pune.**



6S5UVC

The digital textbook can be obtained through DIKSHA APP on a smartphone by using the Q. R. Code given on title page of the textbook and useful audio-visual teaching-learning material of the relevant lesson will be available through the Q. R. Code given in each lesson of this textbook.

First Edition : 2017

© **Maharashtra State Bureau of Textbook Production
and Curriculum Research, Pune - 411 004.**

Reprint : 2022

The Maharashtra State Bureau of Textbook Production and Curriculum Research reserves all rights relating to the book. No part of this book should be reproduced without the written permission of the Director, Maharashtra State Bureau of Textbook Production and Curriculum Research, 'Balbharati', Senapati Bapat Marg, Pune 411004.

Science Subject Committee :

Dr Chandrashekar Murumkar, Chairman

Dr Dilip Sadashiv Jog, Member

Dr Abhay Jere, Member

Dr Sulabha Nitin Vidhate, Member

Smt. Mrinalini Desai, Member

Shri. Gajanan Suryawanshi, Member

Shri. Sudhir Yadavrao Kamble, Member

Smt. Dipali Dhananjay Bhale, Member

Shri. Rajiv Arun Patole, Member-Secretary

Cover and illustrations :

Shri. Vivekanand Shivshankar Patil

Ashna Advani

Typesetting :

DTP Section, Textbook Bureau, Pune

Coordination :

Rajiv Arun Patole

Special Officer for Science

Translation :

Dr Sushma Dilip Jog

Dr Pushpa Khare

Shri. Sandeep Chordiya

Scrutiny :

Smt. Mrinalini Desai

Coordination :

Dhanavanti Hardikar

Academic Secretary for Languages

Santosh Pawar

Assistant Special Officer, English

Paper : 70 GSM Creamwove

Print Order :

Printer :

Production :

Sachchitanand Aphale

Chief Production Officer

Rajendra Vispute

Production Officer

Science Study Group :

Dr Prabhakar Nagnath Kshirsagar

Dr Shaikh Mohammed Waquiuddin H.

Dr Vishnu Vaze

Dr Gayatri Gorakhnath Choukade

Dr Ajay Digambar Mahajan

Smt. Shweta Thakur

Smt. Pushpalata Gawande

Shri. Rajesh Vamanrao Roman

Shri. Hemant Achyut Lagvankar

Shri. Nagesh Bhimsevak Telgote

Smt. Dipti Chandansingh Bisht

Shri. Vishwas Bhawe

Shri. Prashant Panditrao Kolse

Shri. Sukumar Shrenik Navale

Shri. Dayashankar Vishnu Vaidya

Smt. Kanchan Rajendra Sorate

Smt. Anjali Khadke

Smt. Manisha Rajendra Dahivelkar

Smt. Jyoti Medpilwar

Shri. Shankar Bhikan Rajput

Shri. Mohammed Atique Abdul Shaikh

Shri. Manoj Rahangdale

Smt. Jyoti Damodar Karane

Invitees :

Dr Sushma Dilip Jog

Dr Pushpa Khare

Dr Jaydeep Sali

Shri. Sandeep Popatlal Chordiya

Shri. Sachin Ashok Bartakke

Publisher :

Vivek Uttam Gosavi

Controller

Maharashtra State Textbook Bureau,
Prabhadevi, Mumbai - 400 025.



The Constitution of India

Preamble

WE, THE PEOPLE OF INDIA, having solemnly resolved to constitute India into a SOVEREIGN SOCIALIST SECULAR DEMOCRATIC REPUBLIC and to secure to all its citizens:

JUSTICE, social, economic and political;

LIBERTY of thought, expression, belief, faith and worship;

EQUALITY of status and of opportunity; and to promote among them all

FRATERNITY assuring the dignity of the individual and the unity and integrity of the Nation;

IN OUR CONSTITUENT ASSEMBLY this twenty-sixth day of November, 1949, do HEREBY ADOPT, ENACT AND GIVE TO OURSELVES THIS CONSTITUTION.

NATIONAL ANTHEM

Jana-gana-mana-adhināyaka jaya hē
Bhārata-bhāgya-vidhātā,

Panjāba-Sindhu-Gujarāta-Marāthā
Drāvida-Utkala-Banga

Vindhya-Himāchala-Yamunā-Gangā
uchchala-jaladhi-taranga

Tava subha nāmē jāgē, tava subha āsisa māgē,
gāhē tava jaya-gāthā,

Jana-gana-mangala-dāyaka jaya hē
Bhārata-bhāgya-vidhātā,

Jaya hē, Jaya hē, Jaya hē,
Jaya jaya jaya, jaya hē.

PLEDGE

India is my country. All Indians
are my brothers and sisters.

I love my country, and I am proud
of its rich and varied heritage. I shall
always strive to be worthy of it.

I shall give my parents, teachers
and all elders respect, and treat
everyone with courtesy.

To my country and my people,
I pledge my devotion. In their
well-being and prosperity alone lies
my happiness.

Preface

Dear students,

Welcome to Std IX. We have great pleasure in offering to you this Science and Technology textbook based on the new syllabus. From the Primary level till today, you have studied Science from various textbooks. From Std IX onwards, you will be able to study the fundamental concepts of Science and Technology from a different point of view through the medium of the different branches of Science.

The basic purpose of this textbook can be said to be 'Understand and explain to others' the science and technology that relates to our everyday lives. While studying the concepts, principles and theories in Science, do make the effort to understand their connection with day to day affairs. While studying from this textbook, use the sections 'Can you recall?' and 'Can you tell?' for revision. You will learn Science through the many activities given under the titles such as 'Observe and discuss.' and 'Try this' or 'Let's try this'. Activities like 'Use your brain power!', 'Research', 'Think about it.' will stimulate your power of thinking.

Many experiments have been included in the textbook. Carry out these experiments yourself, following the given procedure and making your own observations. Ask your teachers, parents or classmates for help whenever you need it. Interesting information which reveals the science underlying the events we commonly observe, and the technology developed on its basis, has been explained in this textbook through several activities. In this world of speed and technology, you have already become familiar with computers and mobile phones. While studying the textbook, make full and proper use of the devices of information communication technology, which will make your studies so much easier.

While carrying out the given activities and experiments, take all precautions with regard to handling apparatus, chemicals, etc. and encourage others to take the same precautions.

It is expected that while carrying out activities or observation involving plants and animals, you will also make efforts towards conservation of the environment. You must, of course, take all care to avoid doing any harm or causing injury to any plants or animals.

Do tell us about the parts that you like as well as about the difficulties that you face as you read and study and understand this textbook.

Our best wishes for your academic progress.



(Dr Sunil Magar)
Director

Maharashtra State Bureau of Textbook
Production and Curriculum Research, Pune

Pune
Date : 28 April 2017
Akshaya Tritiya
Indian Solar Year :
8 Vaishakh 1939

For teachers

- The real objective of science education is to learn to be able to think about events that are happening around us, logically and with discretion.
- In view of the age group of Std IX students, it would be appropriate now, in the process of science education, to give freedom and scope to the students' own curiosity about the events of the world, their propensity to go looking for the causes behind them and to their own initiative and capacity to take the lead.
- As experimentation is necessary to learn the skills of observation, logic, estimation, comparison and application of available data, which form a part of science education, deliberate efforts must be made to develop these skills while dealing with laboratory experiments given in the textbook. All observations that the students have noted should be accepted, and then they should be helped to achieve the expected results.
- These two years in middle school lay the foundation of higher education in Science. Hence, it is our duty and responsibility to enrich and enhance the students' interest in science. You all will of course always actively pursue the objective of developing their creativity and imbuing them with a scientific temper.
- You can use 'Let's recall' to review the previous knowledge required for a lesson and 'Can you tell?' to introduce a topic by eliciting all the knowledge that the students already have about it from their own reading or experience. You may of course use any of your own activities or questions for this purpose. Activities given under 'Try this' and 'Let's try this' help to explain the content of the lesson. The former are for students to do themselves and the latter are those that you are expected to demonstrate. 'Use your brain power!' is meant for application of previous knowledge as well as the new lesson, and 'Always remember' gives important suggestions/information or values. 'Research', 'Find out', 'Do you know?', 'An introduction to scientists' and 'Institutes at work' are meant to give some information about the world outside the textbook and to develop the habit of doing independent reference work to obtain additional information.
- This textbook is not meant for reading and explaining in the classroom but guiding students to learn the methods of gaining knowledge by carrying out the given activities. An informal atmosphere in the classroom is required to achieve the aims of this textbook. All students should be encouraged to participate in discussions, experiments and activities. Special efforts should be made to organise presentations or report-reading in the class based on students' activities and projects, besides observing of Science Day and other relevant occasions/ days.
- The science and technology content of the textbook has been complemented with Information Communication Technology. These activities are to be conducted under your guidance along with the learning of various new scientific concepts.

Front and back covers : Pictures of various activities, experiments and concepts in the book.

DISCLAIMER Note : All attempts have been made to contact copy righters (©) but we have not heard from them. We will be pleased to acknowledge the copy right holder (s) in our next edition if we learn from them.

Competency Statements Standard IX

The living world

1. To distinguish between the life processes of plants and animals.
2. To use the knowledge about chemical control in living organisms and based on that to understand/ explain events in day to day life.
3. To distinguish between the different types of tissue based on their exact structure.
4. To explain the importance/use of micro-organisms in the production of antibiotics.
5. To explain the cause and effect relationship between micro-organisms and the various life processes of living organisms.
6. To explain the various diseases caused by harmful micro-organisms and their remedies and to be able to take care of one's own health and that of society.
7. To classify plants scientifically.
8. To draw a diagram of the excretory system and nervous system of humans correctly and explain their importance in our life.
9. To explain the importance of the hormones secreted by the endocrine glands in the physical development of the body and to explain their causal relationship with problems like over-excitability and over-emotionality.

Diet and nutrition

1. To explain what is tissue culture and its use in agriculture and related occupations and to give information about processes involved in it.
2. To explain convincingly the importance of agriculture-related occupations for development of society.
3. To analyse the inter-relationship between the food chain and the energy pyramid.
4. To find out the reasons for the changes in the various cycles in nature.
5. To analyse the information about the factors that endanger individual and social health and suggest the remedies.
6. To change one's lifestyle by taking into account the effects of the various diseases and disorders.

Energy

1. To explain the inter-relationship between work and energy and to identify the type of work done in everyday instances.
2. To explain the logic involved in examples of work, energy and power from everyday life, and to solve numerical problems.
3. To explain the importance of various sound-related concepts in everyday life and solve various related problems.
4. To draw a diagram of a SONAR station and explain it.
5. To explain the sound-related functions of the human ear with the help of a diagram.
6. To identify the different types of mirrors, to give a scientific explanation of the images formed by them and to draw the related ray diagrams.
7. To find the number of multiple images by experiment.
8. To find out the scientific reasons for the use of the different types of mirrors in our daily life.

Substances

1. To describe the form, structure and shape of the substances of the universe and explain the science behind it.
2. To verify the laws of chemical combination, conservation of mass and constant proportions and to make inferences based on them.
3. To state the meaning of the concepts of molecular mass and mole, to recognise and write some molecular formulae as also to explain them.
4. To classify substances of everyday use with the help of indicators and to explain their uses on the basis of experiments.
5. To verify by experiments the effects of acids and alkalis on metals and non-metals
6. To eradicate superstitions and rigid customs prevailing in society with the help of relationship between indicators, acids and bases.
7. To produce natural indicators.
8. To demonstrate the effectiveness of the chemical substances.

Natural resources and disaster management

1. To explain the application/ relevance of modern science and technology in the work of the meteorological department.
2. To classify garbage generated in the house and in the surroundings.
3. To produce manure from garbage or reuse the waste materials.
4. To undertake activities related to cleanliness of surroundings and motivate others to do the same.
5. To compile information about how the disaster management systems function and make a presentation based on it. Thus to be able to overcome crisis situations in one's own life.

Motion, Force and Machines

1. To write equations of motion and use them to solve numerical problems.
2. To obtain formulae by drawing graphs involving quantities such as displacement, distance, time and velocity.
3. To verify the cause and effect relationships between motion and laws of motion as seen in various events of everyday life.

The Universe

1. To use the telescope for sky watching.
2. To explain the contribution of astronomy and modern technology to human progress.
3. To distinguish between the different types of telescopes.

Information Communication Technology (ICT)

1. To state the fundamental changes that computer technology has brought about in society and the fields of economics, science, industry, etc.
2. To use the computer to search for information in order to solve various problems.
3. To use the computer to explain scientific concepts.
4. To identify problems arising in using computer software and to resolve them.
5. To use different ways of processing the information obtained by using the computer.

Contents

S.No.	Name of Lesson	Page No.
1.	Laws of Motion	1
2.	Work and Energy.....	18
3.	Current Electricity	30
4.	Measurement of Matter	46
5.	Acids, Bases and Salts	58
6.	Classification of Plants.	75
7.	Energy Flow in an Ecosystem.....	81
8.	Useful and Harmful Microbes.....	88
9.	Environmental Management.....	96
10.	Information Communication Technology (ICT)	108
11.	Reflection of Light.....	115
12.	Study of Sound	128
13.	Carbon : An important element.....	138
14.	Substances in Common Use	150
15.	Life Processes in Living Organisms.....	163
16.	Heredity and Variation.....	179
17.	Introduction to Biotechnology	194
18.	Observing Space : Telescopes	209

1. Laws of Motion



- Motion
- Acceleration
- Distance and displacement
- Newton's laws of motion and related equations.

Motion of an object



Can you tell?

In which of the following examples can you sense motion?
How will you explain presence and absence of motion?

1. The flight of a bird
2. A stationary train
3. Leaves flying through air
4. A stone lying on a hill

We see the motion of several objects every day. Sometimes we cannot see the motion of an object directly, as in the case of a breeze. Can you list other examples of motion, besides those given here?



Think about it.

1. You are travelling in a bus. Is the person sitting next to you in motion?
2. What do you take into consideration to decide if an object is moving or not?

You have learnt that motion is a relative concept. If the position of an object is changing with respect to its surroundings, then it is said to be in motion. Otherwise, it is said to be at rest.

Displacement and distance



Let's try this

1. Measure the distance between points A and B in different ways as shown in figure 1.1(a)
2. Now measure the distance along the dotted line. Which distance is correct according to you and why?



Think about it.

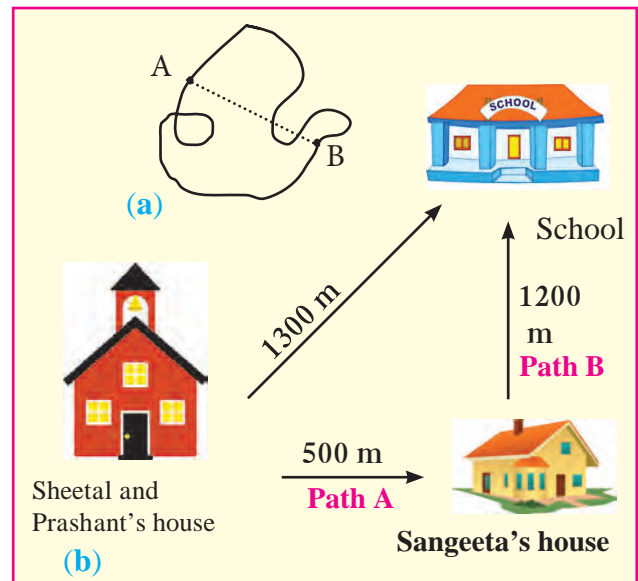

1.1 Location of the school and houses

- A. Sheetal first went to her friend Sangeeta's house on her way to school (see figure 1.1b).
- B. Prashant went straight from home to school. Both are walking with the same speed. Who will take less time to reach the school and why?

In the above example, is there a difference between the actual distance and the distance travelled? What is it?

‘Distance’ is the length of the actual path travelled by an object in motion while going from one point to another, whereas displacement is the minimum distance between the starting and finishing points.



Use your brain power!

(a)

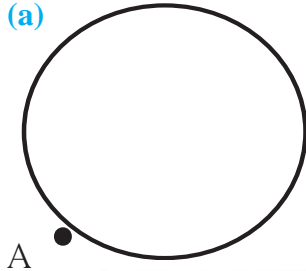

(b)



1. Every morning, Swaralee walks round the edge of a circular field having a radius of 100 m. As shown in figure 1.2 (a), if she starts from the point A and takes one round, how much distance has she walked and what is her displacement?
2. If a car, starting from point P, goes to point Q (see figure 1.2 b) and then returns to point P, how much distance has it travelled and what is its displacement?

1.2 Distance and displacement

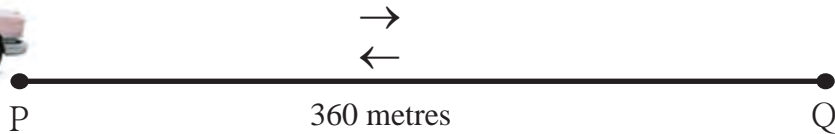

Even if the displacement of an object is zero, the actual distance traversed by it may not be zero.

Speed and velocity



Can you recall?

1. What are vectors and scalars?
2. Which of the quantities distance, speed, velocity, time and displacement are scalars and which are vectors?

$$\text{Speed} = \frac{\text{Total distance travelled}}{\text{Time required}}$$

The distance travelled in one direction by an object in unit time is called its velocity. Here, unit time can be one second, one minute, one hour, etc. If large units are used, one year can also be used as a unit of time.

The displacement that occurs in unit time is called velocity.

$$\text{Velocity} = \frac{\text{Displacement}}{\text{Time}}$$



Always remember

1. The units of speed and velocity are the same. In the SI system, the unit is m/s while in the CGS system, it is cm/s.
2. Speed is related to distance while velocity is related to the displacement.
3. If the motion is along a straight line, the values of speed and velocity are the same, otherwise they can be different.

Velocity is the displacement that occurs in unit time.

In the first example (on page 1), the straight line distance between the houses of Sheetal and Sangeeta is 500 m and that between Sangeeta's house and school is 1200 m. Also, the straight line distance between Sheetal's house and school is 1300 m. Suppose Sheetal takes 5 minutes to reach Sangeeta's house and then 24 minutes to reach school from there, Then,

$$\text{Sheetal's speed along path A} = \frac{\text{Distance}}{\text{Time}} = \frac{500 \text{ m}}{5 \text{ minute}} = 100 \text{ m/minute}$$

$$\text{Sheetal's speed along path B} = \frac{\text{Distance}}{\text{Time}} = \frac{1200 \text{ m}}{24 \text{ minute}} = 50 \text{ m/minute}$$

$$\text{Sheetal's average speed} = \frac{\text{Total distance}}{\text{Total time}} = \frac{1700 \text{ m}}{29 \text{ minute}} = 58.6 \text{ m/minute}$$

$$\text{Sheetal's velocity} = \frac{\text{Displacement}}{\text{Time}} = \frac{1300 \text{ m}}{29 \text{ minute}}$$

$$\text{Sheetal's velocity} = 44.83 \text{ m/minute}$$

Effect of speed and direction on velocity

Sachin is travelling on a motorbike. Explain what will happen in the following events during Sachin's ride (see figure 1.3).

1. What will be the effect on the velocity of the motorcycle if its speed increases or decreases, but its direction remains unchanged?
2. In case of a turning on the road, will the velocity and speed be same?

If Sachin changes the direction of the motorcycle, keeping its speed constant, what will be the effect on the velocity?

3. If, on a turning, Sachin changes the direction as well as the speed of the motorcycle, what will be the effect on its velocity?

It is clear from the above that velocity depends on speed as well as direction and that velocity changes by

1. changing the speed while keeping the direction same
2. changing the direction while keeping the speed same
3. changing the speed as well as the direction.



1.3 Effect on velocity



Always remember

The first scientist to measure speed as the distance /time was Galileo. The speed of sound in dry air is 343.2 m/s while the speed of light is about 3×10^8 m/s. The speed of revolution of the earth around the sun is about 29770 m/s.

Uniform and non-uniform linear motion

Amar, Akbar and Anthony are travelling in different cars with different velocities. The distances covered by them during different time intervals are given in the following table.

Time in the clock	Distance covered by Amar in km	Distance covered by Akbar in km	Distance covered by Anthony in km
5.00	0	0	0
5.30	20	18	14
6.00	40	36	28
6.30	60	42	42
7.00	80	70	56
7.30	100	95	70
8.00	120	120	84



Use your brain power !

1. What is the time interval between the notings of distances made by Amar, Akbar and Anthony?
2. Who has covered equal distances in equal time intervals?
3. Are all the distances covered by Akbar in the fixed time intervals the same?
4. Considering the distances covered by Amar, Akbar and Anthony in fixed time intervals, what can you say about their speeds?

If an object covers equal distances in equal time intervals, it is said to be moving with uniform speed.

If an object covers unequal distances in equal time intervals, it is said to be moving with non-uniform speed. For example, the motion of a vehicle being driven through heavy traffic.

Acceleration



Let's try this.

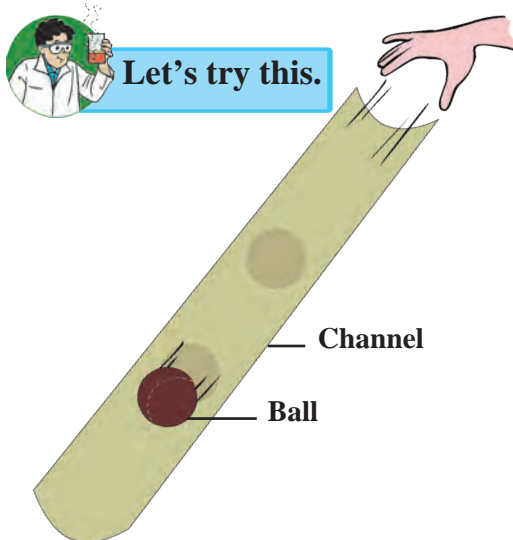

1.4 Change in velocity

1. Take a 1m long plastic tube and cut it lengthwise into two halves.
2. Take one of the channel shaped pieces. Place one of its ends on the ground and hold the other at some height from the ground as shown in figure 1.4.
3. Take a small ball and release it from the upper end of the channel.
4. Observe the velocity of the ball as it rolls down along the channel.
5. Is its velocity the same at all points?
6. Observe how the velocity changes as it moves from the top, through the middle and to the bottom.

You must have all played on a slide in a park. You know that while sliding down, the velocity is less at the top, it increases in the middle and becomes zero towards the end. The rate of change of velocity is called acceleration

$$\text{Acceleration} = \frac{\text{Change in velocity}}{\text{Time}}$$

If the initial velocity is 'u' and in time 't' it changes to the final velocity 'v',

$$\text{Acceleration} = a = \frac{\text{Final velocity} - \text{Initial velocity}}{\text{Time}} \therefore a = \frac{(v-u)}{t}$$

If the velocity of an object changes during a certain time period, then it is said to have accelerated motion. An object in motion can have two types of acceleration.

1. When an object is at rest in the beginning of its motion, what is its initial velocity?
2. When an object comes to rest at the end of its motion, what is its final velocity?

Positive, negative and zero acceleration

An object can have positive or negative acceleration. When the velocity of an object increases, the acceleration is positive. In this case, the acceleration is in the direction of velocity. When the velocity of an object decreases with time, it has negative acceleration. Negative acceleration is also called deceleration. Its direction is opposite to the direction of velocity. If the velocity of the object does not change with time, it has zero acceleration.

Distance-time graph for uniform motion

The following table shows the distances covered by a car in fixed time intervals. Draw a graph of distance against time taking 'time' along the X-axis and 'distance' along the Y-axis in figure 1.5.

Time (seconds)	Distance (metres)
0	0
10	15
20	30
30	45
40	60
50	75
60	90
70	105

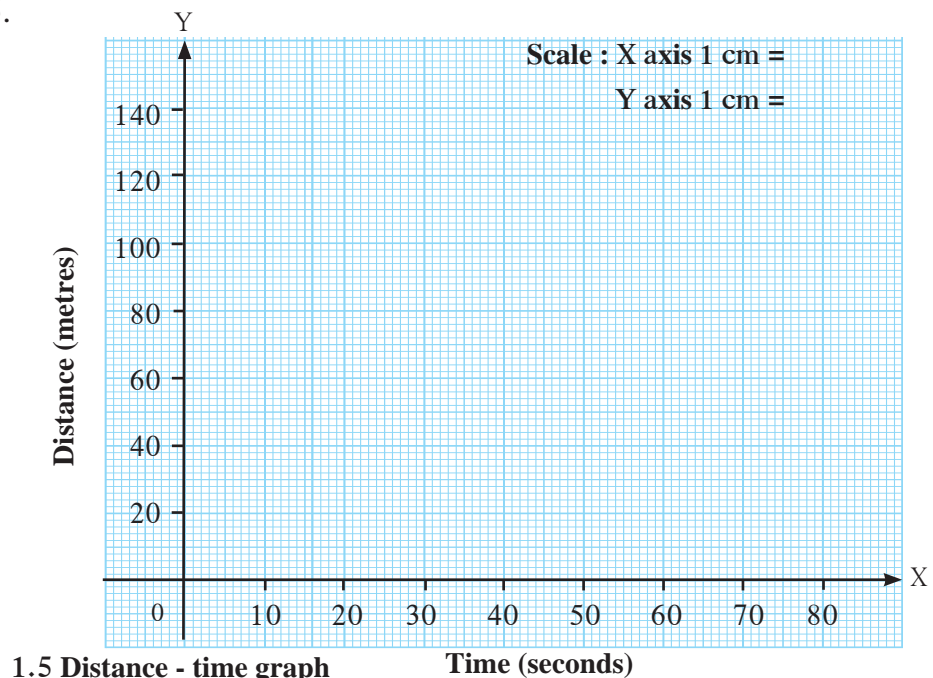

1.5 Distance - time graph



Use your brain power!

1. If the velocity changes by equal amounts in equal time intervals, the object is said to be in uniform acceleration.
2. If the velocity changes by unequal amounts in equal time intervals, the object is said to be non-uniform acceleration.

An object in uniform motion covers equal distances in equal time intervals. Thus, the graph between distance and time is a straight line.



Use your brain power !

In the distance-time graph above, what does the slope of the straight line indicate?

Distance-time graph for non-uniform motion

The following table shows the distances covered by a bus in equal time intervals. Draw a graph of distance against time taking the time along the X-axis and distance along the Y-axis in figure 1.6. Does the graph show a direct proportionality between distance and time?

Time (second)	Distance (metre)
0	0
5	7
10	12
15	20
20	30
25	41
30	50
35	58

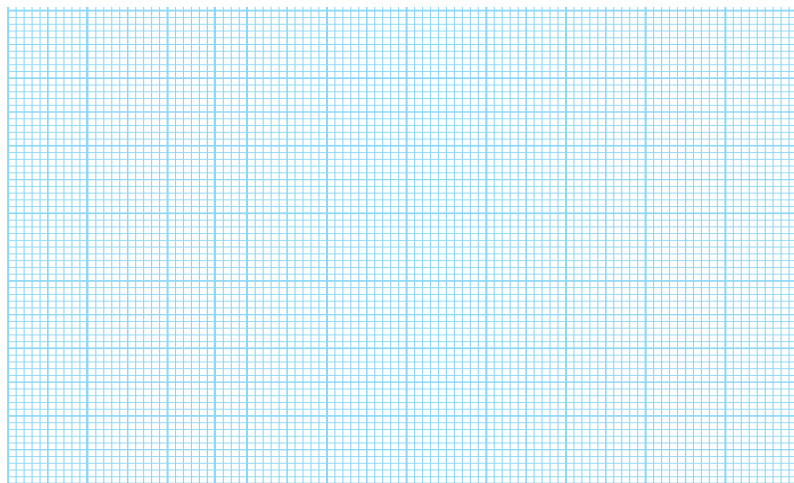

1.6 Distance - time graph

Here, the distance changes non-uniformly with time. Thus, the bus is having non-uniform motion.



Use your brain power !

What difference do you see in the distance-time graphs for uniform and non-uniform motion?

Velocity-time graph for uniform velocity

A train is moving with a uniform velocity of 60 km/hour for 5 hours. The velocity-time graph for this uniform motion is shown in figure 1.7.

1. With the help of the graph, how will you determine the distance covered by the train between 2 and 4 hours?
2. Is there a relation between the distance covered by the train between 2 and 4 hours and the area of a particular quadrangle in the graph? What is the acceleration of the train?

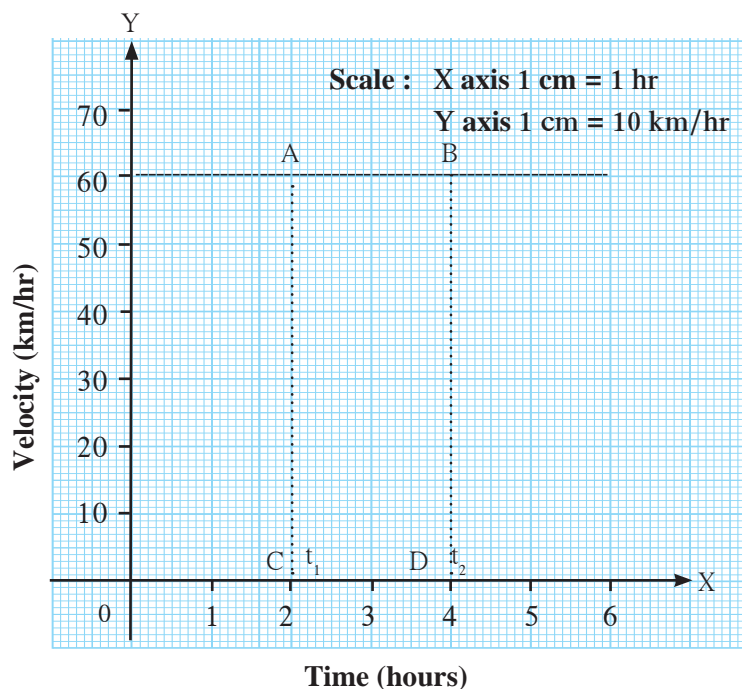

1.7 Velocity - time graph

Velocity-time graph for uniform acceleration

The changes in the velocity of a car in specific time intervals are given in the following table.

Time (seconds)	Velocity (m/s)
0	0
5	8
10	16
15	24
20	32
25	40
30	48
35	56

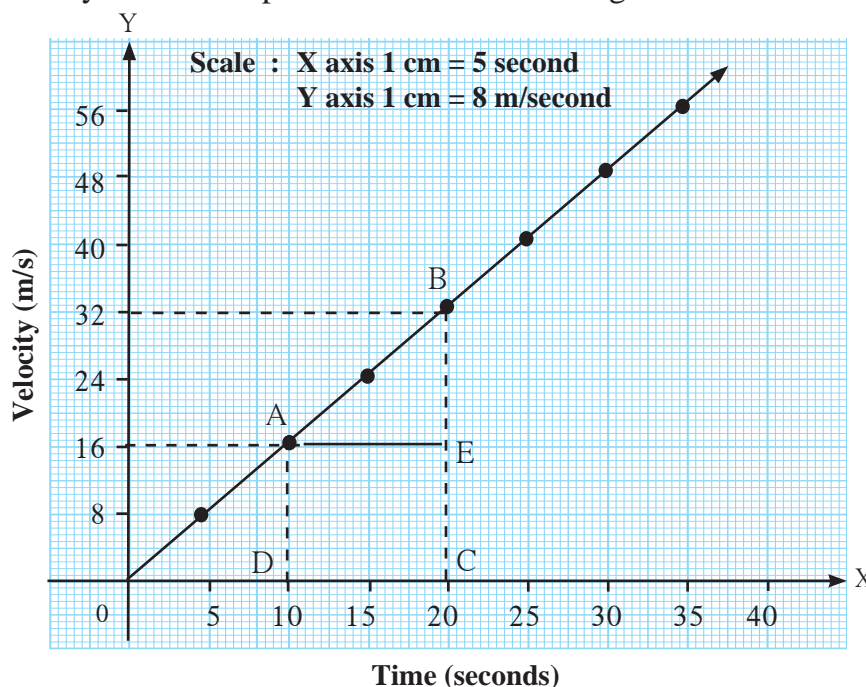

1.8 Velocity - time graph

The velocity-time graph in figure 1.8 shows that,

1. The velocity changes by equal amounts in equal time intervals. Thus, this is uniform acceleration in accelerated motion. How much does the velocity change every 5 minutes?
2. For all uniformly accelerated motions, the velocity-time graph is a straight line.
3. For non-uniformly accelerated motions, the velocity-time graph may have any shape depending on how the acceleration changes with time.

From the graph in figure 1.8, we can determine the distance covered by the car between the 10th and the 20th seconds as we did in the case of the train in the previous example. The difference is that the velocity of the car is not constant (unlike that of the train) but is continuously changing because of uniform acceleration. In such a case, we have to use the average velocity of the car in the given time interval to determine the distance covered in that interval.

From the graph, the average velocity of the car = $\frac{32+16}{2} = 24$ m/s

Multiplying this by the time interval, i.e. 10 seconds gives us the distance covered by the car. Distance covered = 24 m/s x 10 s = 240 m

Check that, similar to the example of the train, the distance covered is given by the area of quadrangle ABCD.

$$A(\square ABCD) = A(\square AECD) + A(\triangle ABE)$$

Equations of motion using graphical method

Newton studied motion of an object and gave a set of three equations of motion. These relate the displacement, velocity, acceleration and time of an object moving along a straight line.

Suppose an object is in motion along a straight line with initial velocity 'u'. It attains a final velocity 'v' in time 't' due to acceleration 'a' its displacement is 's'. The three equations of motion can be written as

$v = u + at$ This is the relation between velocity and time.

$s = ut + \frac{1}{2} at^2$ This is the relation between displacement and time.

$v^2 = u^2 + 2as$ This is the relation between displacement and velocity.

Let us try to obtain these equations by the graphical method.

Equation describing the relation between velocity and time

Figure 1.9 shows the change in velocity with time of a uniformly accelerated object. The object starts from the point D in the graph with velocity u. Its velocity keeps increasing and after time t, it reaches the point B on the graph.

The initial velocity of the object = $u = OD$

The final velocity of the object = $v = OC$

Time = $t = OE$

$$\text{Acceleration (a)} = \frac{\text{Change in velocity}}{\text{Time}}$$

$$= \frac{(\text{Final velocity} - \text{Initial velocity})}{\text{Time}}$$

$$= \frac{(OC - OD)}{t}$$

$$\therefore CD = at \quad \dots\dots (i) \quad (OC - OD = CD)$$

Draw a line parallel to Y axis passing through B. This will cross the X axis in E. Draw a line parallel to X-axis passing through D. This will cross the line BE at A.

From the graph.... $BE = AB + AE$

$$\therefore v = CD + OD \quad \dots\dots (AB = CD \text{ and } AE = OD)$$

$$\therefore v = at + u \quad \dots\dots\dots (\text{from } i)$$

$$\therefore v = u + at$$

This is the first equation of motion.

Equation describing the relation between displacement and time

Let us suppose that an object in uniform acceleration 'a' and it has covered the distance 's' within time 't'. From the graph in figure 1.9, the distance covered by the object during time 't' is given by the area of quadrangle DOEB.

$$\therefore s = \text{area of quadrangle DOEB}$$

$$= \text{area (rectangle DOEA)} + \text{area of triangle (DAB)}$$

$$\therefore s = (AE \times OE) + \left(\frac{1}{2} \times [AB \times DA] \right)$$

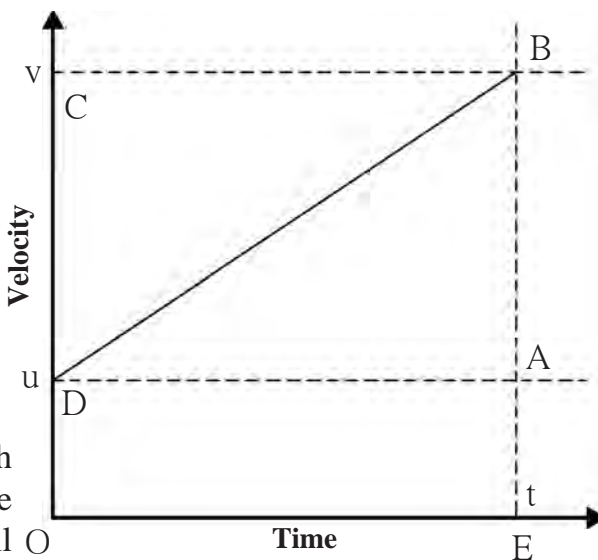

1.9 Velocity - time graph

But, $AE = u$, $OE = t$ and $(OE = DA = t)$

$AB = at$ --- ($AB = CD$) --- from (i)

$$\therefore s = u \times t + \frac{1}{2} \times at \times t$$

$$\therefore \text{Newton's second equation of motion is } s = ut + \frac{1}{2} at^2$$

Equation describing the relation between displacement and velocity

We have seen that from the graph in figure 1.9 we can determine the distance covered by the object in time t from the area of the quadrangle $DOEB$. $DOEB$ is a trapezium. So we can use the formula for its area.

$\therefore s = \text{area of trapezium } DOEB$

$\therefore s = \frac{1}{2} \times \text{sum of lengths of parallel sides} \times \text{distance between the parallel sides}$

$\therefore s = \frac{1}{2} \times (OD + BE) \times OE$ But, $OD = u$, $BE = v$ and $OE = t$

$\therefore s = \frac{1}{2} \times (u + v) \times t$ ----- (ii)

But, $a = \frac{(v-u)}{t}$

$\therefore t = \frac{(v-u)}{a}$ ----- (iii)

$$\therefore s = \frac{1}{2} \times (u + v) \times \frac{(v-u)}{a}$$

$$\therefore s = \frac{(v+u)(v-u)}{2a}$$

$$\therefore 2as = (v+u)(v-u) = v^2 - u^2$$

$$\therefore v^2 = u^2 + 2as$$

this is Newton's third equation of motion.



Always remember

The velocity of an accelerated object changes with time. Change in the velocity can be due to a change in direction or magnitude of the velocity or both.

Uniform circular motion



Let's try this

Observe the tip of the second hand of a clock. What can you say about its velocity and speed?

The speed of the tip of a clock is constant, but the direction of its displacement and therefore, its velocity is constantly changing. As the tip is moving along a circular path, its motion is called uniform circular motion. Can you give more examples of such motion?



Try out and think about it

1. Draw a rectangular path as shown figure 1.10
2. Place the tip of your pencil on the middle of any side of the square path and trace the path.
3. Note how many times you have to change the direction while tracing the complete path.
4. Now repeat this action for a pentagonal, hexagonal, octagonal path and note the number of times you have to change direction.
5. If you increase the number of sides of the polygon and make it infinite, how many times will you have to change the direction? What will be the shape of the path?

This shows that as we increase the number of sides, we have to keep changing direction more and more times. And when we increase the number of sides to infinity, the polygon becomes a circle.

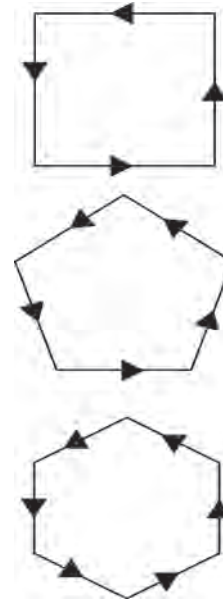

1.10 Changes in direction

When an object is moving with a constant speed along a circular path, the change in velocity is only due to the change in direction. Hence, it is accelerated motion. When an object moves with constant speed along a circular path, the motion is called uniform circular motion, e.g. the motion of a stone in a sling or that of any point on a bicycle wheel when they are in uniform motion.

If an object, moving along a circular path of radius 'r', takes time 't' to come back to its starting position, its speed can be determined using the formula given below :

$$\text{Speed} = \frac{\text{Circumference}}{\text{Time}}$$

$$v = \frac{2 \pi r}{t} \quad r = \text{radius of the circle}$$



Research

Find out more examples of circular motion in day to day life.

Determining the direction of velocity in uniform circular motion.



Let's try this

Take a circular disc and put a five rupee coin at a point along its edge.

Make it move around its axis by putting a pin through it. When the disc is moved at higher speed, the coin will be thrown off as shown in figure 1.11. Note the direction in which it is thrown off. Repeat the action placing the coin at different points along the edge of the circle and observe the direction in which the coin is thrown off.

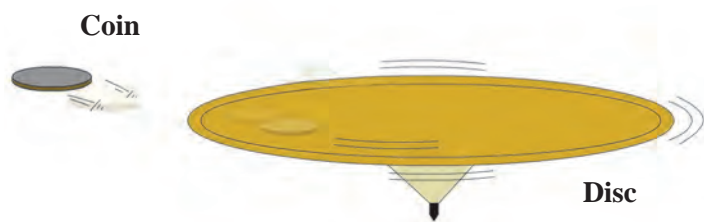

1.11 The coin and the disc

The coin will be thrown off in the direction of the tangent which is perpendicular to the radius of disc. Thus, the direction in which it gets thrown off depends on its position at the moment of getting thrown off. It means that, as the coin moves along a circular path the direction of its motion is changing at every point.

Solved examples

Example 1: An athlete is running on a circular track. He runs a distance of 400 m in 25 s before returning to his original position. What is his average speed and velocity?

Given : Total distance travelled = 400 m

Total displacement = 0, as he returns to his original position.

Total time = 25 seconds.

Average speed = ?, Average velocity = ?

$$\text{Average speed} = \frac{\text{Total distance covered}}{\text{Total time taken}} = \frac{400}{25} = 16 \text{ m/s}$$

$$\text{Average velocity} = \frac{\text{Total displacement}}{\text{Total time taken}} = \frac{0}{25} = 0 \text{ m/s}$$

Example 2: An aeroplane taxis on the runway for 30 s with an acceleration of 3.2 m/s^2 before taking off. How much distance would it have covered on the runway?

Given : $a = 3.2 \text{ m/s}^2$, $t = 30 \text{ s}$, $u = 0$, $s = ?$

$$s = ut + \frac{1}{2}at^2 = 0 \times 30 + \frac{1}{2} \times 3.2 \times 30^2 = 1440 \text{ m.}$$

Example 3: A kangaroo can jump 2.5 m vertically. What must be the initial velocity of the kangaroo?

Given :

$$a = 9.8 \text{ m/s}^2$$

$$s = 2.5 \text{ m}$$

$$v = 0$$

$$u = ?$$

$$v^2 = u^2 + 2as$$

$(0)^2 = u^2 + 2 \times (-9.8) (2.5)$ Negative sign is used as the acceleration is in the direction opposite to that of velocity.

$$0 = u^2 - 49$$

$$u^2 = 49$$

$$u = 7 \text{ m/s}$$

Example 4 : A motorboat starts from rest and moves with uniform acceleration. If it attains the velocity of 15 m/s in 5 s, calculate the acceleration and the distance travelled in that time.

Given :

Initial velocity, $u = 0$,

final velocity, $v = 15 \text{ m/s}$, time, $t = 5 \text{ s}$.

Acceleration = $a = ?$

From the first equation of motion

$$a = \frac{v-u}{t} = \frac{15-0}{5} = 3 \text{ m/s}^2$$

From the second equation of motion, the distance covered will be

$$s = ut + \frac{1}{2} at^2$$
$$s = 0 \times 5 + \frac{1}{2} 3 \times 5^2$$
$$= 0 + \frac{75}{2} = 37.5 \text{ m}$$

Newton's laws of motion

What could be the reason for the following?

1. A static object does not move without the application of a force.
2. The force which is sufficient to lift a book from a table is not sufficient to lift the table.
3. Fruits on a tree fall down when its branches are shaken.
4. An electric fan keeps on rotating for some time even after it is switched off.

If we look for reasons for the above, we realize that objects have some inertia. We have learnt that inertia is related to the mass of the object. Newton's first law of motion describes this very property and is therefore also called the law of inertia.

Newton's first law of motion



Let's try this

Fill a glass with sand. Keep a piece of cardboard on it. Keep a five rupee coin on the cardboard. Now strike the cardboard hard using your fingers. Observe what happens.

Balanced and unbalanced force

You must have played tug-of-war. So long as the forces applied by both the sides are equal, i.e. balanced, the centre of the rope is static in spite of the applied forces. On the other hand, when the applied forces become unequal, i.e. unbalanced, a net force gets applied in the direction of the greater force and the centre of the rope shifts in that direction.

'An object continues to remain at rest or in a state of uniform motion along a straight line unless an external unbalanced force acts on it.'

When an object is at rest or in uniform motion along a straight line, it does not mean that no force is acting on it. Actually there are a number of forces acting on it, but they cancel one another so that the net force is zero. Newton's first law explains the phenomenon of inertia, i.e. the inability of an object to change its state of motion on its own. It also explains the unbalanced forces which cause a change in the state of an object at rest or in uniform motion.

All instances of inertia are examples of Newton's first law of Motion.

Newton's second law of motion



Let's try this

- A.** 1. Ask your friend to drop one plastic and one rubber ball from the same height.
2. You catch the balls. Which ball was easier to catch and why?
- B.** 1. Ask your friend to throw a ball towards you at slow speed. Try to catch it.
2. Now ask your friend to throw the same ball at high speed towards you. Try to catch it. Which ball could you catch with greater ease? Why?

The effect of one object striking another object depends both on the mass of the former object and its velocity. This means that the effect of the force depends on a property related to both mass and velocity of the striking object. This property was termed 'momentum' by Newton.

Momentum has magnitude as well as direction. Its direction is the same as that of velocity. In SI system, the unit of momentum is kg m/s, while in CGS system, it is g cm/s.

If an unbalanced force applied on an object causes a change in the velocity of the object, then it also causes a change in its momentum. The force necessary to cause a change in the momentum of an object depends upon the rate of change of momentum.

Momentum (P) : Momentum is the product of mass and velocity of an object. $P = m v$. Momentum is a vector quantity.

'The rate of change of momentum is proportional to the applied force and the change of momentum occurs in the direction of the force.'

Suppose an object of mass m has an initial velocity u . When a force F is applied in the direction of its velocity for time t , its velocity becomes v .

\therefore The initial momentum of the object = mu ,
Its final momentum after time $t = mv$

\therefore Rate of change of momentum = $\frac{\text{Change in momentum}}{\text{Time}}$

\therefore Rate of change of momentum = $\frac{mv - mu}{t} = \frac{m(v - u)}{t} = ma$

According to Newton's second law of motion, the rate of change of momentum is proportional to the applied force.

$\therefore ma \propto F$

$\therefore F = k ma$ ($k =$ Constant of proportionality and its value is 1).

$F = m \times a$

Consider two objects having different masses which are initially at rest. The initial momentum for both is zero. Suppose a force 'F' acts for time 't' on both objects. The lighter object starts moving faster than the heavier object. However, from the above formula, we know that the rate of change of momentum i.e. 'F' in both objects is same and the total change in their momentum will also be same i.e. 'Ft'. Thus, if the same force is applied on different objects, the change in momentum is the same.

In SI system, the unit of force is newton.

Newton (N) : The force necessary to cause an acceleration of 1 m/s^2 in an object of mass 1 kg is called 1 newton.

$$1 \text{ N} = 1 \text{ kg} \times 1 \text{ m/s}^2$$

In CGS system the unit of force is a dyne.

Dyne: The force necessary to cause an acceleration of 1 cm/s^2 in an object of mass 1 gm is called 1 dyne.

$$1 \text{ dyne} = 1 \text{ g} \times 1 \text{ cm/s}^2$$



Use your brain power !

Why is there a thick bed of sand for a high jumper to fall on after his jump?

Newton's third law of motion



Let's try this

1. Take a plastic boat and make a hole at its rear end.
2. Inflate a balloon and fix it on the hole in the boat. Release the boat in water. What happens to the boat as the air in the balloon escapes slowly? Why?

We have learnt about force and its effect on an object through Newton's first and second laws of motion.

'However, in nature force cannot act alone.' Force is a reciprocal action between two objects. Forces are always applied in pairs. When one object applies a force on another object, the latter object also simultaneously applies a force on the former object. The forces between two objects are always equal and opposite. This idea is expressed in Newton's third law of motion. The force applied by the first object is called action force while the force applied by the second object on the first is called reaction force.

'Every action force has an equal and opposite reaction force which acts simultaneously.'



Use your brain power !

1. Action and reaction are terms that express force.
2. These forces act in pairs. One force cannot exist by itself.
3. Action and reaction forces act simultaneously.
4. Action and reaction forces act on different objects. They do not act on the same object and hence cannot cancel each other's effect.

1. While hitting a ball with a bat, the speed of the bat decreases.
2. A gun recoils i.e. moves backwards when a bullet is fired.
3. Mechanism of firing of a rocket.

How will you explain these with the help of Newton's third law of motion?

Law of conservation of momentum

Suppose an object A has mass m_1 and its initial velocity is u_1 . An object B has mass m_2 and initial velocity u_2 .

According to the formula for momentum, the initial momentum of A is $m_1 u_1$ and that of B is $m_2 u_2$.

Suppose these two objects collide. Let the force on A due to B be F_1 . This force will cause acceleration in A and its velocity will become v_1 .

$$\therefore \text{Momentum of A after collision} = m_1 v_1$$

According to Newton's third law of motion, A also exerts an equal force on B but in the opposite direction. This will cause a change in the momentum of B. If its velocity after collision is v_2 ,

The momentum of B after collision = $m_2 v_2$. If F_2 is the force that acts on object B,

$$F_2 = -F_1$$

$$\therefore m_2 a_2 = -m_1 a_1 \dots \therefore F = ma$$

$$\therefore m_2 \times \frac{(v_2 - u_2)}{t} = -m_1 \times \frac{(v_1 - u_1)}{t} \dots \therefore a = \frac{(v - u)}{t}$$

$$\therefore m_2 (v_2 - u_2) = -m_1 (v_1 - u_1)$$

$$\therefore m_2 v_2 - m_2 u_2 = -m_1 v_1 + m_1 u_1$$

$$\therefore (m_2 v_2 + m_1 v_1) = (m_1 u_1 + m_2 u_2)$$

The magnitude of total final momentum = the magnitude of total initial momentum.

Thus, if no external force is acting on two objects, then their total initial momentum is equal to their total final momentum. This statement is true for any number of objects.

'When no external force acts on two interacting objects, their total momentum remains constant. It does not change.'

This is a corollary to Newton's third law of motion. The momentum is unchanged after the collision. The momentum gets redistributed between the colliding objects. The momentum of one of the objects decreases while that of the other increases. Thus, we can also state this corollary as follows.

'When two objects collide, the total momentum before collision is equal to the total momentum after collision.'

In order to understand this principle, let us consider the example of a bullet fired from a gun. When a bullet of mass m_1 is fired from a gun of mass m_2 , its velocity becomes v_1 , and its momentum becomes $m_1 v_1$. Before firing the bullet, both the gun and the bullet are at rest and hence the total initial momentum is zero. According to the above law, the total final momentum also has to be zero. Thus, the forward moving bullet causes the gun to move backward after firing. This backward motion of the gun is called its **recoil**. The velocity of recoil, v_2 , is such that,

$$m_1 v_1 + m_2 v_2 = 0 \text{ or } v_2 = - \frac{m_1}{m_2} \times v_1$$

As the mass of the gun is much higher than the mass of the bullet, the velocity of the gun is much smaller than the velocity of the bullet. The magnitude of the momentum of the bullet and that of the gun are equal and their directions are opposite. Thus, the total momentum is constant. Total momentum is also constant during the launch of a rocket.

Solved examples

Example 1: The mass of a cannon is 500 kg and it recoils with a speed of 0.25 m/s. What is the momentum of the cannon?

Given : mass of the cannon = 500 kg, recoil speed = 0.25 m/s Momentum = ?

Momentum = $m \times v = 500 \times 0.25 = 125 \text{ kg m/s}$

Example 2: 2 balls have masses of 50 gm and 100 gm respectively and they are moving along the same line in the same direction with velocities of 3 m/s and 1.5 m/s respectively. They collide with each other and after the collision, the first ball moves with a velocity of 2.5 m/s. Calculate the velocity of the other ball after collision.

Given :

The mass of first ball = $m_1 = 50 \text{ g} = 0.05 \text{ kg}$, mass of the second ball = $m_2 = 100 \text{ g} = 0.1 \text{ kg}$

Initial velocity of the first ball = $u_1 = 3 \text{ m/s}$, Initial velocity of the second ball = $u_2 = 1.5 \text{ m/s}$

Final velocity of the first ball = $v_1 = 2.5 \text{ m/s}$, Final velocity of the second ball = $v_2 = ?$

According to the law of conservation of momentum, total initial momentum = Total final momentum.

$$m_1 u_1 + m_2 u_2 = m_1 v_1 + m_2 v_2$$

$$(0.05 \times 3) + (0.1 \times 1.5) = (0.05 \times 2.5) + (0.1 \times v_2)$$

$$\therefore (0.15) + (0.15) = 0.125 + 0.1v_2$$

$$\therefore 0.3 = 0.125 + 0.1 v_2$$

$$\therefore 0.1v_2 = 0.3 - 0.125 \quad \therefore v_2 = \frac{0.175}{0.1} = 1.75 \text{ m/s}$$



Exercises

1. Match the first column with appropriate entries in the second and third columns and remake the table.

S. No.	Column 1	Column 2	Column 3
1	Negative acceleration	The velocity of the object remains constant	A car, initially at rest reaches a velocity of 50 km/hr in 10 seconds
2	Positive acceleration	The velocity of the object decreases	A vehicle is moving with a velocity of 25 m/s
3	Zero acceleration	The velocity of the object increases	A vehicle moving with the velocity of 10 m/s, stops after 5 seconds.

2. Clarify the differences

- Distance and displacement
- Uniform and non-uniform motion.

3. Complete the following table.

u (m/s)	a (m/s ²)	t (sec)	v = u + at (m/s)
2	4	3	-
-	5	2	20

u (m/s)	a (m/s ²)	t (sec)	s = ut + $\frac{1}{2}$ at ² (m)
5	12	3	-
7	-	4	92

u (m/s)	a (m/s ²)	s (m)	v ² = u ² + 2as (m/s) ²
4	3	-	8
-	5	8.4	10

4. Complete the sentences and explain them.

- The minimum distance between the start and finish points of the motion of an object is called the of the object.
- Deceleration is ----- acceleration
- When an object is in uniform circular motion, its changes at every point.
- During collision remains constant.
- The working of a rocket depends on Newton's law of motion.

5. Give scientific reasons.

- When an object falls freely to the ground, its acceleration is uniform.
- Even though the magnitudes of action force and reaction force are equal and their directions are opposite, their effects do not get cancelled.
- It is easier to stop a tennis ball as compared to a cricket ball, when both are travelling with the same velocity.
- The velocity of an object at rest is considered to be uniform.

6. Take 5 examples from your surroundings and give explanation based on Newtons laws of motion.

7. Solve the following examples.

- An object moves 18 m in the first 3 s, 22 m in the next 3 s and 14 m in the last 3 s. What is its average speed? **(Ans: 6 m/s)**
- An object of mass 16 kg is moving with an acceleration of 3 m/s². Calculate the applied force. If the same force is applied on an object of mass 24 kg, how much will be the acceleration? **(Ans: 48 N, 2 m/s²)**
- A bullet having a mass of 10 g and moving with a speed of 1.5 m/s, penetrates a thick wooden plank of mass 900 g. The plank was initially at rest. The bullet gets embedded in the plank and both move together. Determine their velocity. **(Ans: 0.15 m/s)**
- A person swims 100 m in the first 40 s, 80 m in the next 40 s and 45 m in the last 20 s. What is the average speed? **(Ans: 2.25 m/s²)**

Project:

Obtain information about commonly used gadgets or devices which are based on the principles of Newton's laws of motion.



2. Work and Energy



- Work
- Energy
- Mechanical energy
- Law of conservation of energy
- Free fall



Observe



2.1 Various activities



Can you tell?

1. In which of the pictures above has work been done?
2. From scientific point of view, when do we say that no work was done?

Generally, any mental or physical activity is referred to as work. When we walk or run, the energy in our body is used to do the necessary work. We say that a girl who is studying is working or performing work. But that is mental work.

In physics, we deal with physical work. Work has a special meaning in physics.

‘Work is said to be done when a force applied on an object causes displacement of the object.’

You have already learnt that the work done by a force acting on an object is the product of the magnitude of the force and the displacement of the object in the direction of the force. Thus, $\text{Work} = \text{force} \times \text{displacement}$



Can you recall?

What are different types of forces and their examples?

Minakshee wants to displace a wooden block from point A to point B along the surface of a table as shown in figure 2.2A. She has used force F for the purpose. Has all the energy she spent been used to produce acceleration in the block? Which forces have been overcome using that energy?



Use your brain power !

You have learnt how to calculate the work done on an object when the displacement is in the direction of the applied force. But if the displacement is not in the direction of the applied force, how do we calculate the amount of work done?



Observe and discuss.

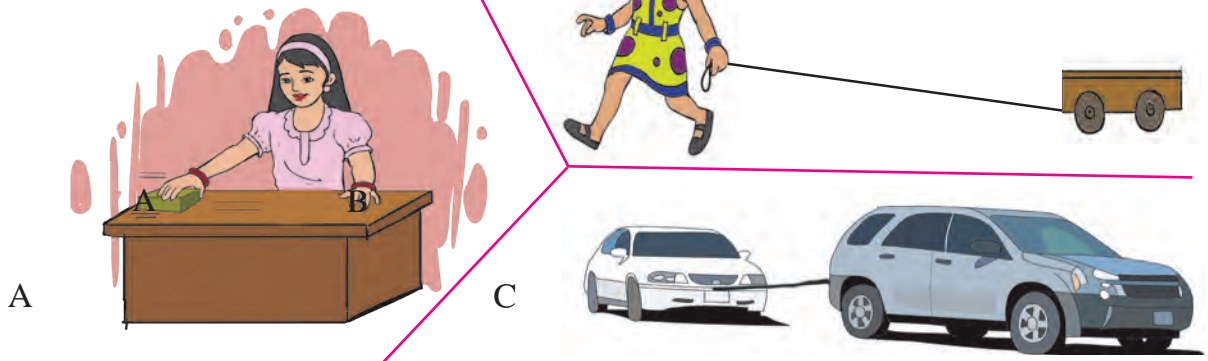

2.2 Displacement of an object

You must have seen the events depicted in the pictures B and C above. When a child pulls a toy with the help of a string, the direction of the force is different from that of displacement. Similarly, when a large vehicle tows a small one, the directions of force and the displacements are different. In both these cases, the direction of force makes an angle with the direction of displacement. Let us see how to calculate work done in such cases.

When a child pulls a toy cart, force is applied along the direction of the string while the cart is pulled along the horizontal surface. In this case, in order to calculate the amount of work done, we have to convert the applied force into the force acting along the direction of displacement.

Let F be the applied force and F_1 be its component in the direction of displacement. Let s be the displacement. The amount of work done is given by

$$W = F_1 \cdot s \dots\dots\dots (1)$$

The force F is applied in the direction of the string i. e. at an angle with the horizontal. Let θ be the angle that the string makes with the horizontal. We can determine the component F_1 , of this force F , which acts in the horizontal direction by means of trigonometry.

(see figure2.3)

$$\cos \theta = \text{base} / \text{hypotenuse}$$

$$\cos \theta = F_1 / F$$

$$F_1 = F \cos \theta$$

Thus, the work done by F_1 is

$$W = F \cos \theta \cdot s$$

$$W = F s \cos \theta$$

Enter your conclusions about the work done for the specific values of θ in the following table.

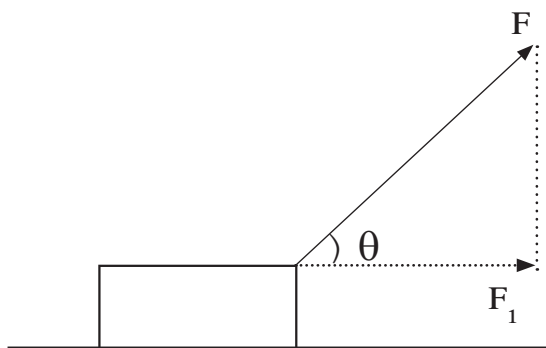

2.3 Force used for the displacement

θ	$\cos \theta$	$W = F s \cos \theta$	Conclusion
0°	1	$W = F s$	
90°	0	0	
180°	-1	$W = -F s$	

Unit of work

Work = Force \times Displacement

In SI system, the unit of force is newton (N) and the unit of displacement is metre (m). Thus, the unit of force is newton-metre. This is called joule.

1 Joule : If a force of 1 newton displaces an object through 1 metre in the direction of the force, the amount of work done on the object is 1 joule.

$$\therefore 1 \text{ joule} = 1 \text{ newton} \times 1 \text{ metre}$$

$$1 \text{ J} = 1 \text{ N} \times 1 \text{ m}$$

In CGS system, the unit of force is dyne and that of displacement is centimeter (cm). Thus, the unit of work done is dyne-centimetre. This is called an erg.

1 erg : If a force of 1 dyne displaces an object through 1 centimetre in the direction of the force, the amount of work done is 1 erg.

$$1 \text{ erg} = 1 \text{ dyne} \times 1 \text{ cm}$$

Relationship between joule and erg

We know that, 1 newton = 10^5 dyne and 1 m = 10^2 cm

Work = force \times displacement

$$1 \text{ joule} = 1 \text{ newton} \times 1 \text{ m}$$

$$1 \text{ joule} = 10^5 \text{ dyne} \times 10^2 \text{ cm}$$

$$= 10^7 \text{ dyne cm}$$

$$1 \text{ joule} = 10^7 \text{ erg}$$

Positive, negative and zero work



Think before you answer

Discuss the directions of force and of displacement in each of the following cases.

1. Pushing a stalled vehicle
2. Catching the ball which your friend has thrown towards you.
3. Tying a stone to one end of a string and swinging it round and round by the other end of the string.
4. Walking up and down a staircase; climbing a tree.
5. Stopping a moving car by applying brakes.

You will notice that in some of the above examples, the direction of the force and displacement are the same. In some other cases, these directions are opposite to each other, while in some cases, they are perpendicular to each other. In these cases, the work done by the force is as follows.

1. When the force and the displacement are in the same direction ($\theta = 0^\circ$), the work done by the force is positive.
2. When the force and the displacement are in opposite directions ($\theta = 180^\circ$), the work done by the force is negative.
3. When the applied force does not cause any displacement or when the force and the displacement are perpendicular to each other ($\theta = 90^\circ$), the work done by the force is zero.



Try this

Take a plastic cup and make a hole in the centre of its bottom. Take a long thread, double it and pass it through the hole. Tie a thick enough knot at the end so that the knot will not pass through the hole, taking care that the two loose ends are below the bottom of the cup. Tie a nut each to the two ends as shown in figure 2.4. Now do the following.

As shown in figure 'A', put the cup on a table, keep one of the nuts in the cup and let the thread carrying the other nut hang down along the side of the table. What happens?

As shown in figure 'B', when the cup is sliding along the table, stop it by putting a ruler in its path.

As shown in figure 'C', keep the cup at the centre of the table and leave the two nuts hanging on opposite sides of the table.

Questions:

1. Figure A- Why does the cup get pulled?
2. Figure B- What is the relation between the displacement of the cup and the force applied through the ruler?
3. In figure C - Why doesn't the cup get displaced?
4. What is the type of work done in figures A, B and C?

In the three actions above, what is the relationship between the applied force and the displacement?

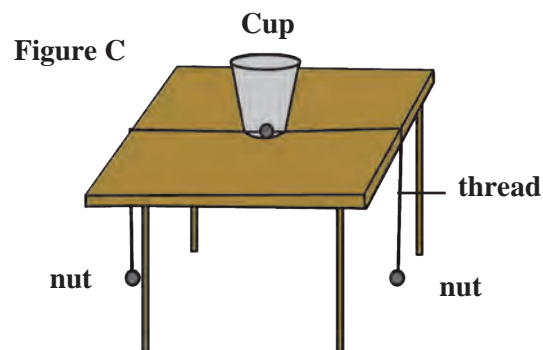
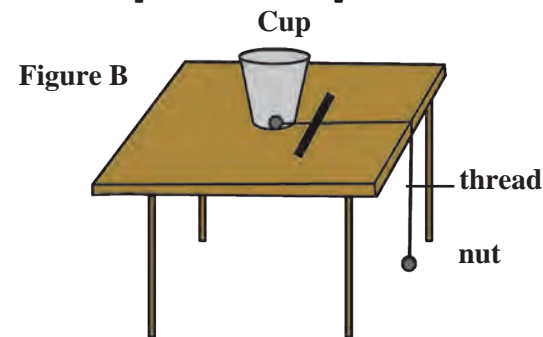
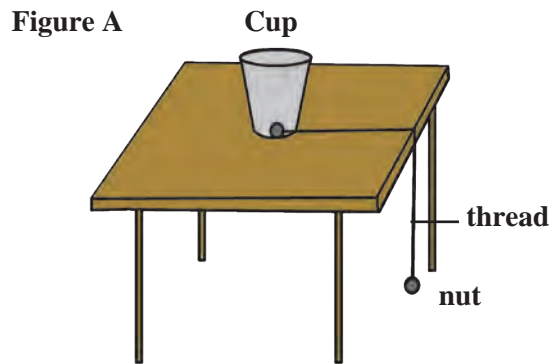

2.4 Positive, negative and zero work

Suppose an artificial satellite is moving around the earth in a circular orbit. As the gravitational force acting on the satellite (along the radius of the circle) and its displacement (along the tangent to the circle) are perpendicular to each other, the work done by the gravitational force is zero

Institutes at work

The National Physical Laboratory, New Delhi, was conceptualized in 1943. It functions under the Council of Scientific and Industrial Research. It conducts basic research in the various branches of physics and helps various industries and institutes engaged in developmental work. Its main objective is to establish national standards of various physical quantities.

Solved examples

Example 1: Calculate the work done to take an object of mass 20 kg to a height of 10 m.

$$(g = 9.8 \text{ m/s}^2)$$

Given: $m = 20 \text{ kg}$; $s = 10 \text{ m}$

$$g = 9.8 \text{ m/s}^2$$

$$\therefore F = m \cdot g$$

$$= 20 \times (-9.8)$$

(The negative sign is taken because the displacement is opposite to the direction of the force.)

$$F = -196 \text{ N}$$

$$\therefore W = F s$$

$$= -196 \times 10$$

$$W = -1960 \text{ J}$$

(The negative sign appears because the direction of force is opposite to the direction of displacement so that the work done is negative.)

Energy

Why does it happen?

1. If a pot having a plant is kept in the dark, the plant languishes.
2. On increasing the volume of a music system or TV beyond a limit, the vessels in the house start vibrating.
3. Collecting sunlight on a paper with the help of a convex lens burns the paper.

The capacity of a body to perform work is called its energy. The units of work and energy are the same. The unit in SI system is **joule** while that in cgs system is **erg**.

You have learnt that energy exists in various forms like mechanical, heat, light, sound, electro-magnetic, chemical, nuclear and solar. In this chapter, we are going to study two forms of mechanical energy, namely, potential energy and kinetic energy.

Kinetic energy

What will happen in the following cases?

1. A fast cricket ball strikes the stumps.
2. The striker hits a coin on the carom board.
3. One marble strikes another in a game of marbles.

From the above examples we understand that when a moving object strikes a stationary object, the stationary object moves. Thus, the moving object has some energy, part or all of which it shares with the stationary object, thereby setting it in motion. 'The energy which an object has because of its motion is called its kinetic energy'. The work done by a force to displace a stationary object through a distance s is the kinetic energy gained by the object.

Kinetic energy = work done on the object

$$\therefore \text{K.E.} = F \times s$$

Example 2 : Pravin has applied a force of 100 N on an object, at an angle of 60° to the horizontal. The object gets displaced in the horizontal direction and 400 J work is done. What is the displacement of the object?

$$(\cos 60^\circ = \frac{1}{2})$$

Given :

$$\theta = 60^\circ$$

$$F = 100 \text{ N}$$

$$W = 400 \text{ J}, s = ?$$

$$W = F s \cos \theta$$

$$400 = 100 \times s \times \frac{1}{2}$$

$$\frac{400}{100} = \frac{1}{2} \times s$$

$$4 \times 2 = s$$

$$\therefore s = 8 \text{ m}$$

The object will be displaced through 8 m.

Expression for kinetic energy :

Suppose a stationary object of mass m moves because of an applied force. Let u be its initial velocity (here $u = 0$). Let the applied force be F . This generates an acceleration a in the object, and, after time t , the velocity of the object becomes equal to v . The displacement during this time is s . The work done on the object, $W = F \cdot s$

$$W = F \times s$$

According to Newton's second law of motion,

$$F = ma \text{ ----- (1) Similarly, using Newton's second equation of motion}$$

$$s = ut + \frac{1}{2} at^2 \quad \text{However, as initial velocity is zero, } u = 0.$$

$$s = 0 + \frac{1}{2} at^2$$

$$s = \frac{1}{2} at^2 \text{ -----(2)}$$

$$\therefore W = ma \times \frac{1}{2} at^2 \text{ ----- using equations (1) and (2)}$$

$$W = \frac{1}{2} m(at)^2 \text{ -----(3)}$$

Using Newton's first equation of motion

$$v = u + at$$

$$\therefore v = 0 + at$$

$$\therefore v = at$$

$$\therefore v^2 = (at)^2 \text{ -----(4)}$$

$$\therefore W = \frac{1}{2} mv^2 \text{ ----- using equations (3) and (4)}$$

The kinetic energy gained by an object is the amount of work done on the object.

$$\therefore \text{K. E.} = W$$

$$\therefore \text{K. E.} = \frac{1}{2} mv^2$$

Example : A stone having a mass of 250 gm is falling from a height. How much kinetic energy does it have at the moment when its velocity is 2 m/s?

Given : $m = 250 \text{ g}$ $m = 0.25 \text{ kg}$

$$v = 2 \text{ m/s}$$

$$\text{K.E.} = \frac{1}{2} mv^2 = \frac{1}{2} \times 0.25 \times (2)^2 = 0.5 \text{ J}$$



Use your brain power !

The mass of a moving body is doubled, how many times will the kinetic energy increase?

Potential energy



Try this

1. An arrow is released from a stretched bow.
2. Water kept at a height flows through a pipe into the tap below.
3. A compressed spring is released.

Which words describe the state of the object in the above examples? Where did the energy required to cause the motion of objects come from?

If the objects were not brought in those states, would they have moved?

‘The energy stored in an object because of its specific state or position is called its potential energy.’

1. Hold a chalk at a height of 5 cm from the floor and release it.
2. Now stand up straight and then release the chalk.
3. Is there a difference in the results of the two activities? If so, why?

Expression for potential energy

To carry an object of mass ‘m’ to a height ‘h’ above the earth’s surface, a force equal to ‘mg’ has to be used against the direction of the gravitational force. The amount of work done can be calculated as follows.

$$\text{Work} = \text{force} \times \text{displacement}$$

$$W = mg \times h$$

$$\therefore W = mgh$$

\therefore The amount of potential energy stored in the object because of its displacement

$$\text{P.E.} = mgh \quad (W = \text{P.E.})$$

\therefore Displacement to height h causes energy equal to mgh to be stored in the object.

Example : 500 kg water is stored in the overhead tank of a 10 m high building. Calculate the amount of potential energy stored in the water.

Given :

$$h = 10 \text{ m}, m = 500 \text{ kg} \quad g = 9.8 \text{ m/s}^2$$

$$\therefore \text{P.E.} = mgh$$

$$= 10 \times 9.8 \times 500$$

$$\text{P.E.} = 49000 \text{ J}$$

Ajay and Atul have been asked to determine the potential energy of a ball of mass m kept on a table as shown in the figure. What answers will they get? Will they be different? What do you conclude from this?

Potential energy is relative. The heights of the ball with respect to Ajay and Atul are different. So the potential energy with respect to them will be different.

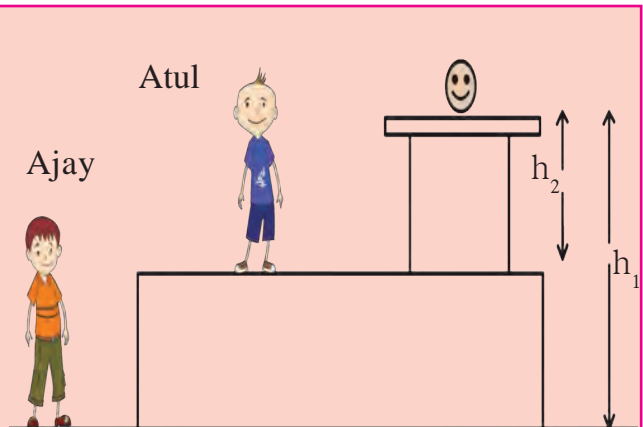

Transformation of energy



Can you tell?

Which are the different forms of energy? Which type of energy is used in each of the following processes?

1. A stretched piece of rubber 2. Fast moving car 3. The whistling of a cooker due to steam 4. The crackers exploded in Diwali 5. A fan running on electricity 6. Drawing out pieces of iron from garbage, using a magnet 7. Breaking of a glass window pane because of a loud noise.

Energy can be transformed from one type to another. For example, the exploding firecrackers convert the chemical energy stored in them into light, sound and heat energy.

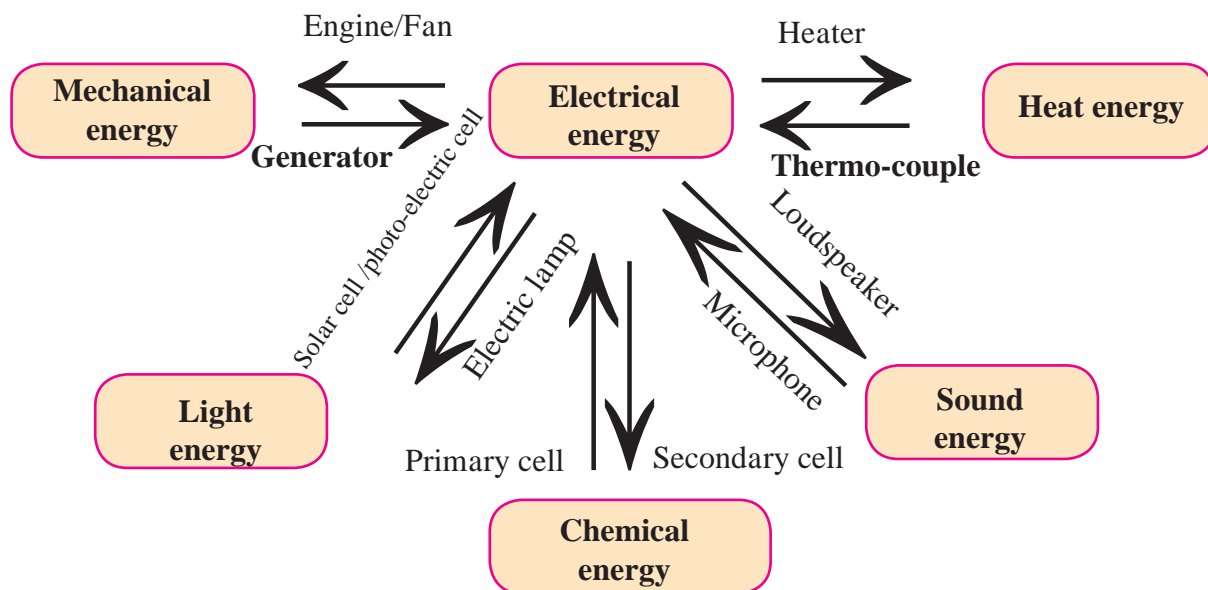

2.5 Transformation of energy

Observe the above diagram (figure 2.5) and discuss how transformation of energy takes place, giving example of each.

Law of conservation of energy

‘Energy can neither be created nor destroyed. It can be converted from one form into another. Thus, the total amount of energy in the universe remains constant’.



Try this

Make two pendulums of the same length with the help of thread and two nuts. Tie another thread in the horizontal position.

Tie the two pendulums to this horizontal thread in such a way that they will not hit each other while swinging. Now swing one of the pendulums and observe. What do you see?

You will see that as the speed of oscillation of the pendulum slowly decreases, the second pendulum which was initially stationary, begins to swing. Thus, one pendulum transfers its energy to the other.

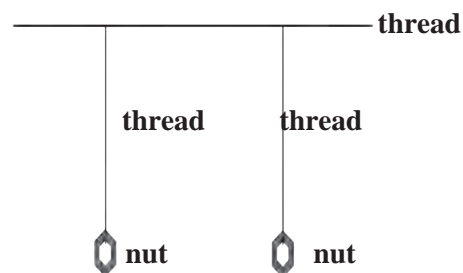

2.6 Coupled oscillators

Free fall

If we release an object from a height, it gets pulled towards the earth because of the gravitational force. An object falling solely under the influence of gravitational force is said to be in free fall or to be falling freely. Let us look at the kinetic and potential energies of an object of mass m , falling freely from height h , when the object is at different heights

As shown in the figure, the point A is at a height h from the ground. Let the point B be at a distance x , vertically below A. Let the point C be on the ground directly below A and B. Let us calculate the energies of the object at A, B and C.

1. When the object is stationary at A, its initial velocity is $u = 0$

$$\therefore \text{K.E.} = \frac{1}{2} \text{mass} \times \text{velocity}^2$$

$$= \frac{1}{2} mu^2$$

$$\text{K.E.} = 0$$

$$\text{P.E.} = mgh$$

$$\therefore \text{Total energy} = \text{K.E.} + \text{P.E.}$$

$$= 0 + mgh$$

$$\text{Total Energy} = mgh \text{ --- (1)}$$

2. Let the velocity of the object be v_B when it reaches point B, having fallen through a distance x .

$$u = 0, s = x, a = g$$

$$v^2 = u^2 + 2as$$

$$v_B^2 = 0 + 2gx$$

$$v_B^2 = 2gx$$

$$\therefore \text{K.E.} = \frac{1}{2} mv_B^2 = \frac{1}{2} m(2gx)$$

$$\text{K.E.} = mgx$$

$$\text{Height of the object when at B} = h - x$$

$$\therefore \text{P.E.} = mg(h - x)$$

$$\text{P.E.} = mgh - mgx$$

$$\therefore \text{Total Energy T.E.} = \text{K.E.} + \text{P.E.}$$

$$= mgx + mgh - mgx$$

$$\therefore \text{T.E.} = mgh \text{ --- (2)}$$

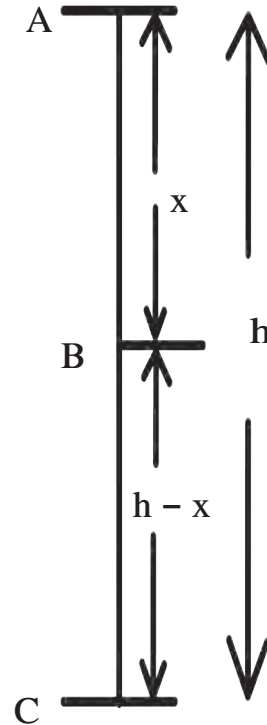

2.7 Free fall

3. Let the velocity of the object be v_C when it reaches the ground, near point C.

$$u = 0, s = h, a = g$$

$$v^2 = u^2 + 2as$$

$$v_C^2 = 0 + 2gh$$

$$\therefore \text{K.E.} = \frac{1}{2} mv_C^2 = \frac{1}{2} m(2gh)$$

$$\text{K.E.} = mgh$$

The height of the object from the ground at point C is

$$h = 0$$

$$\therefore \text{P.E.} = mgh = 0$$

$$\therefore \text{T.E.} = \text{K.E.} + \text{P.E.}$$

$$\text{T.E.} = mgh \text{ --- (3)}$$

From equations (1), (2) and (3) we see that the total energy of the object is the same at the three points A, B and C.

Thus, every object has potential energy when it is at a height above the ground and it keeps getting converted to kinetic energy as the object falls towards the ground. On reaching the ground (point C), all the potential energy gets converted to kinetic energy. But at any point during the fall the total energy remains constant.

$$\text{i.e., T.E.} = \text{P.E.} + \text{K.E.}$$

$$\text{T.E. at A} = mgh + 0 = mgh$$

$$\text{T.E. at B} = mgx + mg(h - x) = mgh$$

$$\text{T.E. at C} = 0 + mgh = mgh$$



Power



Think before you answer

1. Can your father climb stairs as fast as you can?
2. Will you fill the overhead water tank with the help of a bucket or an electric motor?
3. Suppose Rajashree, Yash and Ranjeet have to reach the top of a small hill. Rajashree went by car, Yash went cycling while Ranjeet went walking. If all of them choose the same path, who will reach first and who will reach last?

In the above examples, the work done is the same in each example but the time taken to perform the work is different for each person or each method. The fast or slow rate of the work done is expressed in terms of power. 'Power is the rate at which work is done.'

If W amount of work is done in time t then,

$$\text{Power} = \frac{\text{Work}}{\text{Time}} \quad P = \frac{W}{t}$$

In SI system the unit of work is J, so the unit of power is

J/s. This is called watt

$$1 \text{ watt} = 1 \text{ joule} / 1 \text{ second}$$

In the industrial sector the unit used to measure power is called 'horse power.'

$$1 \text{ horse power} = 746 \text{ watt.}$$

The unit of energy for commercial use is kilo watt hour.

1000 joule work performed in 1 second is 1 kilowatt power.

$$\begin{aligned} 1 \text{ kW h} &= 1 \text{ kW} \times 1 \text{ hr} \\ &= 1000 \text{ W} \times 3600 \text{ s} \\ &= 3600000 \text{ J} \end{aligned}$$

$$1 \text{ kW h} = 3.6 \times 10^6 \text{ J}$$

Electricity used for domestic purposes is measured in units of kilowatt hour.

$$1 \text{ kW h} = 1 \text{ unit}$$

An introduction to scientists

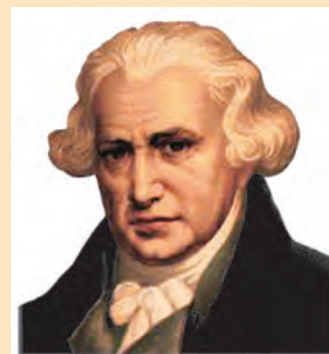

The steam engine was invented in 1781 by the Scottish scientist James Watt (1736 – 1819). This invention brought about an industrial revolution. The unit of power is called Watt in his honour. James Watt was the first to use the term 'horse-power'.

Solved problems

Example 1 : Swaralee takes 20 s to carry a bag weighing 20 kg to a height of 5 m. How much power has she used?

Given : $m = 20 \text{ kg}$, $h = 5 \text{ m}$, $t = 40 \text{ s}$

\therefore The force which has to be applied by Swaralee,

$$F = mg = 20 \times 9.8$$

$$F = 196 \text{ N}$$

Work done by Swaralee to carry the bag to a height of 5 m,

$$W = F s = 196 \times 5 = 980 \text{ J}$$

$$\therefore \text{power} = (P) = \frac{\text{Work}}{t} = \frac{980}{40}$$

$$P = 24.5 \text{ W}$$

Example 2 : A 25 W electric bulb is used for 10 hours every day. How much electricity does it consume each day?

Given :

$$P = 25, W = 0.025 \text{ kW}$$

$$\therefore \text{Energy consumed} = \text{power} \times \text{time} \\ = 0.025 \times 10$$

$$\text{Energy} = 0.25 \text{ kW hr}$$

Websites for more information :

www.physicscatalyst.com

www.tryscience.org

Exercises



1. Write detailed answers?

- Explain the difference between potential energy and kinetic energy.
- Derive the formula for the kinetic energy of an object of mass m , moving with velocity v .
- Prove that the kinetic energy of a freely falling object on reaching the ground is nothing but the transformation of its initial potential energy.
- Determine the amount of work done when an object is displaced at an angle of 30° with respect to the direction of the applied force.
- If an object has 0 momentum, does it have kinetic energy? Explain your answer.
- Why is the work done on an object moving with uniform circular motion zero?

2. Choose one or more correct alternatives.

- For work to be performed, energy must be
 - transferred from one place to another
 - concentrated
 - transformed from one type to another
 - destroyed
- Joule is the unit of ...
 - force
 - work
 - power
 - energy
- Which of the forces involved in dragging a heavy object on a smooth, horizontal surface, have the same magnitude?
 - the horizontal applied force
 - gravitational force
 - reaction force in vertical direction
 - force of friction
- Power is a measure of the
 - the rapidity with which work is done
 - amount of energy required to perform the work
 - The slowness with which work is performed
 - length of time

- e. While dragging or lifting an object, negative work is done by
(i) the applied force (ii) gravitational force (iii) frictional force (iv) reaction force

3. Rewrite the following sentences using proper alternative.

- a. The potential energy of your body is least when you are
(i) sitting on a chair (ii) sitting on the ground (iii) sleeping on the ground (iv) standing on the ground
- b. The total energy of an object falling freely towards the ground ...
(i) decreases (ii) remains unchanged (iii) increases (iv) increases in the beginning and then decreases
- c. If we increase the velocity of a car moving on a flat surface to four times its original speed, its potential energy
(i) will be twice its original energy (ii) will not change (iii) will be 4 times its original energy (iv) will be 16 times its original energy.
- d. The work done on an object does not depend on
(i) displacement (ii) applied force (iii) initial velocity of the object (iv) the angle between force and displacement.

4. Study the following activity and answer the questions.

1. Take two aluminium channels of different lengths.
2. Place the lower ends of the channels on the floor and hold their upper ends at the same height.
3. Now take two balls of the same size and weight and release them from the top end of the channels. They will roll down and cover the same distance.

Questions

1. At the moment of releasing the balls, which energy do the balls have?
2. As the balls roll down which energy is converted into which other form of energy?
3. Why do the balls cover the same distance on rolling down?
4. What is the form of the eventual total energy of the balls?
5. Which law related to energy does the above activity demonstrate ? Explain.

5. Solve the following examples.

- a. An electric pump has 2 kW power. How much water will the pump lift every minute to a height of 10 m?
(Ans : 1224.5 kg)
- b. If a 1200 W electric iron is used daily for 30 minutes, how much total electricity is consumed in the month of April? (Ans :18 Unit)
- c. If the energy of a ball falling from a height of 10 metres is reduced by 40%, how high will it rebound?
(Ans : 6 m)
- d. The velocity of a car increases from 54 km/hr to 72 km/hr. How much is the work done if the mass of the car is 1500 kg ?
(Ans. : 131250 J)
- e. Ravi applied a force of 10 N and moved a book 30 cm in the direction of the force. How much was the work done by Ravi?

(Ans: 3 J)

Project :

Study the various instances of transformation of energy you see around you and discuss them in class.



3. Current Electricity



- Potential and potential difference
- Conductors and insulators (bad conductors)
- Electrical resistance and Ohm's Law
- Connection of resistors and effective resistance



All around us

Electricity is of utmost importance in the modern world. We depend on it for almost everything in our day to day life. In order to avoid the inconvenience faced due to failure of power supply, hospitals, banks, offices and private institutions make alternative arrangements with the help of generators. Electricity is used for running electric furnaces, electric motors and several other instruments used in industries.

Domestic appliances like the fridge, electric oven, mixer, fans, washing machines, vacuum cleaner, rotimaker, etc. have helped us by saving time and labour. All these devices cannot be run without electricity.

Not only human beings but some animals also use electricity. For example, fishes such as eels use electricity to catch their prey and also for self-defence. The lightning that strikes the earth is an excellent example of natural flow of electricity. What if we could collect and store this electricity!



Can you recall?

You must have seen a waterfall. Which way does the water flow?

For the generation of electricity, water is released from a dam at a higher level and because of gravity, it falls to a lower level. Thus, as we know, the direction of flow of water between two points depends on the level of the two points.

Potential and potential difference



Try this

Equipment : Two plastic bottles, rubber tube, clamp, water.

Procedure : Set up the experiment as shown in figure 3.1. Then remove the clamp from the rubber tube. Note your observations. Answer the following questions.

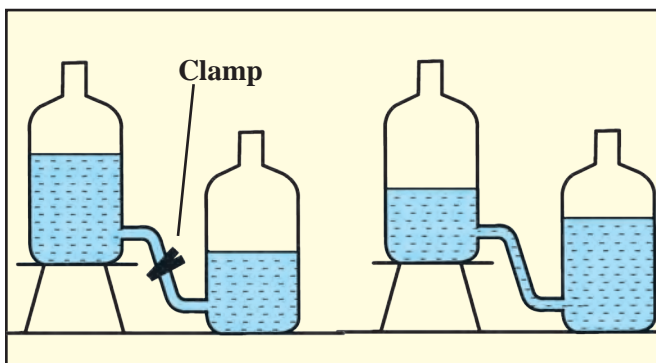

3.1 Level of water and direction of flow

1. What happens when the clamp is removed?
2. Does the water stop flowing? Why?
3. What will you do to keep the water flowing for a longer duration?

Just like water, the flow of electric charge between two points depends on a kind of electric level at those points. This level is called electric potential.

A positive charge flows from a point of higher potential to a point of lower potential. We have seen earlier that electricity flows due to the conduction of negatively charged electrons. Electrons flow from the point of lower potential to a point of higher potential. A lightning strike is the flow of electrons from point of lower (negative) potential on the clouds to the point of higher (zero) potential on the earth. We shall study the definition of electric potential in higher standards.

The difference between the values of potentials at two points A and B is called the potential difference between them.

In the figure 3.2, conductor A is at a higher potential than conductor B. When these two are connected by a conducting wire, a potential difference is created between its two ends and electrons will flow from B to A through the wire. This flow will continue until the two conductors, A and B have the same potential, i.e. until their potential difference becomes zero. Only then will the flow of electrons stop.

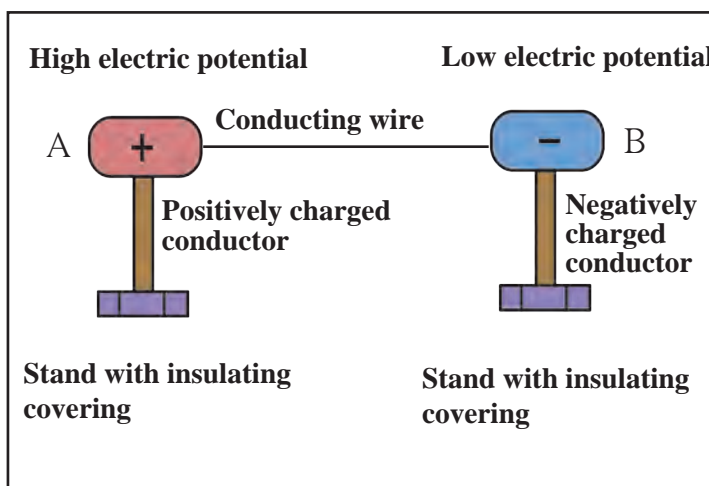

3.2 Potential difference and flow of electricity

Work has to be done against the electric field to take a positive charge from a point of lower potential to a point of higher potential.

Potential difference of a cell

The difference in potential between the positive and negative terminals of a cell is the potential difference of that cell. This potential difference is caused by chemical reactions occurring inside the cell. The potential difference sets the electrons in motion and results in the flow of electricity through a conducting wire connected to the two ends of the cell.

The amount of work done to carry a unit positive charge from point A to point B is called the electric potential difference between the two points.

$$\text{Potential difference between two points} = \frac{\text{Work}}{\text{Total charge transferred}}, V = \frac{W}{Q}$$

$$1 \text{ V} = \frac{1\text{J}}{1\text{C}} \quad \text{The unit of potential difference in SI system is volt.}$$

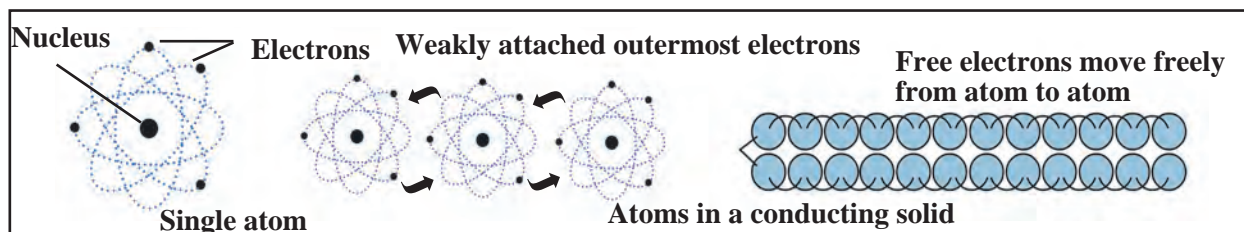

3.3 Free electrons



An introduction to scientists

The Italian scientist Alessandro Volta constructed the first electric cell. The unit of potential difference is named 'volt' in his honour.

Volta's simple electric cell



Do you know?

Very small values of potential difference are expressed in the following units.

1. 1mV (millivolt) = 10^{-3} V
2. 1 μ V (microvolt) = 10^{-6} V

Large values of potential difference are expressed in the following units.

1. 1kV (kilovolt) = 10^3 V
2. 1MV (megavolt) = 10^6 V

Free electrons : Every atom of a metallic conductor has one or more outermost electrons which are very weakly bound to the nucleus. These are called free electrons. As shown in figure 3.3, these electrons can easily move from one part of a conductor to its other parts. The negative charge of the electrons also gets transferred as a result of this motion. The free electrons in a conductor are the carriers of negative charge.

Current flowing through a wire

As shown in the figure 3.4 A, if a conducting wire is not connected to a cell, its free electrons move randomly in all directions in the space between the atoms. When we connect the ends of the wire to the two terminals of a cell, electric force acts on the electrons. Being negatively charged, they start moving from the negative (lower potential) to the positive (higher potential) terminal of the cell, as shown in figure 3.4 B. Due to the flow of these electrons, current starts to flow through the wire. This motion of electrons is irregular but there is a definite, non-zero value to their average velocity.

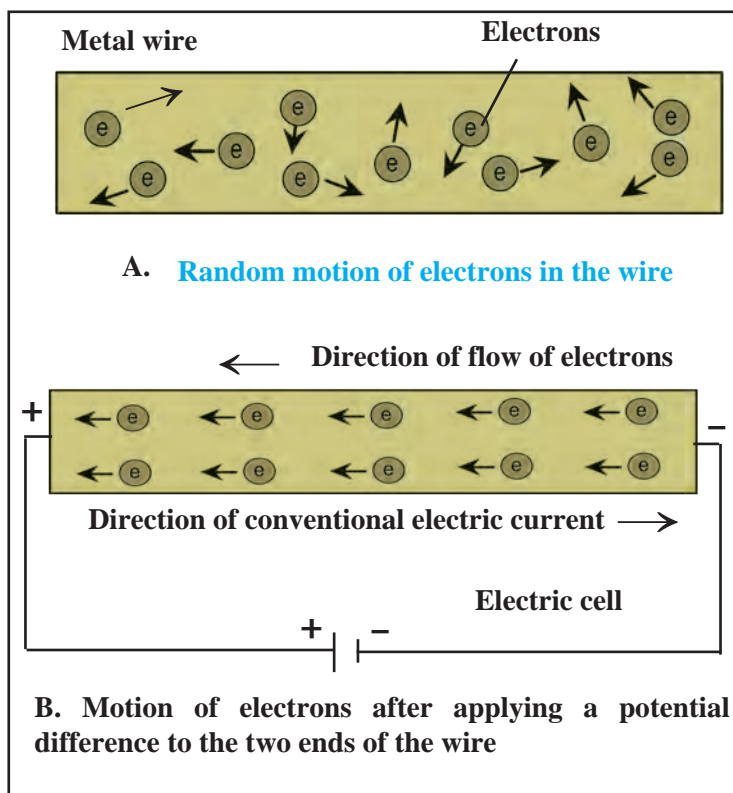

3.4 Motion of free electrons

Electric current

An electric current is the flow of electrons through a conductor. Quantitatively, current (I) is defined as the charge passing through a conductor in unit time.

If charge Q is flowing through cross-section of a conductor in time t then the

$$\text{current} = I = \frac{Q}{t}$$

The unit of charge in SI units is Coulomb (C). Current is expressed in Ampere (A). The charge of one electron is 1.6×10^{-19} C.

Ampere : One ampere current is said to flow in a conductor if one Coulomb charge flows through it every second.

$$1\text{A} = \frac{1\text{C}}{1\text{s}}$$



Do you know?

Very small values of current are expressed in the following units.

1. 1mA (mili ampere) = 10^{-3} A
2. 1 μ A (micro ampere) = 10^{-6} A

The French mathematician and scientist, Ampere, conducted a number of experiments on electricity. Today, we can measure the current flowing in a conductor only because of his work. The unit of current is called ampere in recognition of his work.



Example : A current of 0.4 A flows through a conductor for 5 minutes. How much charge would have passed through the conductor?

Given : I = 0.4 A

$$t = 5 \text{ min} = 5 \times 60 \text{ s} = 300 \text{ s}$$

Formula $Q = I \times t$

$$Q = 0.4 \text{ A} \times 300 \text{ s}$$

$$Q = 120 \text{ C.}$$

\therefore Charge passing through the conductor = 120 C

Even though, electrons move from negative end to positive end, conventionally, the direction of current flow is taken to be opposite of the direction of flow of electrons i.e. from the +ve end to the -ve end of a cell.

Using ICT

Study current electricity and other scientific concepts with the help of simulation technology .

Website :

www.phet.colorado.edu

www.edumedia-sciences.com

Find some more websites like the ones mentioned above and share them with others.

Resistance and Ohm's Law

Ohm's law

The relationship between the current flowing through a wire (I) and the potential difference across its ends (V) can be obtained from the law that was given by the German scientist George Simon Ohm.

If the physical state of a conductor remains constant, the current (I) flowing through it is directly proportional to the potential difference (V) between its two ends.

$$I \propto V$$

$$I = kV \quad (k = \text{constant of proportionality})$$

$$I \times \frac{1}{k} = V \quad \left(\frac{1}{k} = R = \text{Resistance of the conductor} \right)$$

$$I \times R = V \quad \text{Hence } V = IR \quad \text{or } R = \frac{V}{I}$$

This is known as Ohm's law.

Physical state of a conductor means its length, area of cross-section, temperature and the material it is made up of.

We can obtain the SI unit of resistance from the above formula. Potential difference and current are measured in Volts and Amperes respectively. The unit of resistance is called Ohm. It is indicated by the symbol Ω .

$$\therefore \frac{1 \text{ Volt}}{1 \text{ Ampere}} = 1 \text{ Ohm } (\Omega)$$

Resistance of one Ohm : If one Ampere current flows through a conductor when one Volt potential difference is applied between its ends, then the resistance of the conductor is one Ohm.

Resistance and resistivity of a conductor

As shown in figure 3.4, there are a large number of free electrons in a conductor. They are constantly in random motion. When a potential difference is applied between the two ends of the conductor, these electrons start moving from the end at lower potential to the end at higher potential. This directional motion of the electrons causes the flow of current. Moving electrons strike the atoms and ions which lie along their path. Such collisions cause hindrance to the flow of electrons and oppose the current. This hindrance is called the resistance of the conductor.

Resistivity : At a given temperature, the resistance (R) of a conductor depends on its length (L), area of cross-section (A) and the material it is made of.



German physicist, George Simon Ohm established a law for measuring the resistance of a conductor. In his honour, the unit of resistance is called the Ohm.

If the resistance of a conductor is R , then

$$R \propto L$$

Also, $R \propto \frac{1}{A}$

$$\therefore R \propto \frac{L}{A}$$

$$R = \rho \frac{L}{A}$$

Think about it

How will you prove that the unit of resistivity is $\Omega \text{ m}$?

Resistivity of some materials

Copper - $1.7 \times 10^{-8} \Omega \text{ m}$

Nichrome - $1.1 \times 10^{-6} \Omega \text{ m}$

Diamond - 1.62×10^{13} to $1.62 \times 10^{18} \Omega \text{ m}$

ρ is the constant of proportionality and is called the resistivity of the material. The unit of resistivity in SI units is Ohm metre ($\Omega \text{ m}$). Resistivity is a specific property of a material and different materials have different resistivity

Electric circuit

A continuous path of an electric current through conducting wires connected to the two ends of a cell and other resistances is called an electric circuit. A circuit is depicted by a figure. This figure shows how different components are to be connected in the circuit, by using special symbols for each of the components. Such a figure is called an electric circuit diagram.

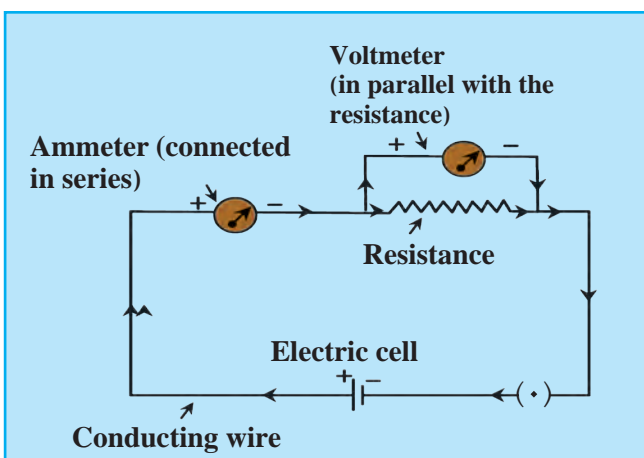

3.5 Electrical circuit

In the circuit in figure 3.5, an ammeter is used to measure current and a voltmeter to measure the potential difference between the two ends of a resistor. As the voltmeter has a very high resistance, only very small current flows through it.





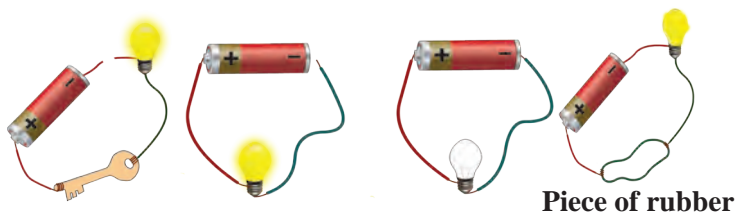



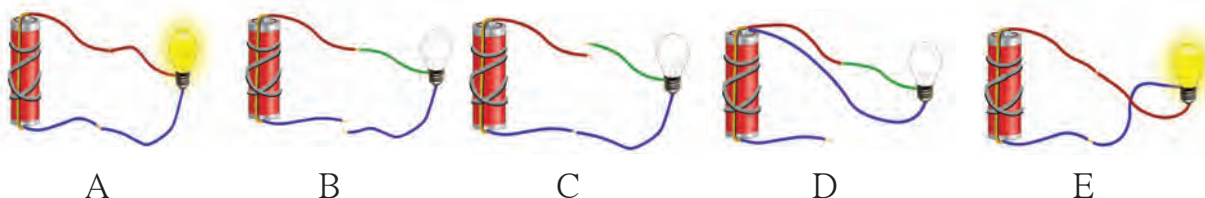



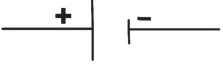





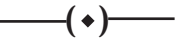



Observe



1. Point out the mistakes in the figure above.
2. Why are the bulbs in Figures B, C and D below not lighting up ?



Symbols for components of an electric circuit and their uses

Component	Picture	Symbol	Use
Electric cell			To apply a potential difference between two ends of a conductor
Battery (collection of a number of cells)			To apply a larger potential difference between two ends of a conductor
Open tap key or plug key			To stop the flow of current flowing in a circuit by disconnecting two ends of a wire
Closed tap key or plug key			To start the flow of current in a circuit by connecting two ends of a wires.
Connecting (conducting) wires			To connect various components in the circuit.
Crossing wires			To show wires which cross but are not connected
Light bulb			To test the flow of electricity : Lighted : current is flowing; unlighted : current is not flowing
Resistance			To control the flow of current in the circuit
Variable resistance			To change the resistance as required and thereby control the current
Ammeter			To measure the current flowing in the circuit
Voltmeter			To measure the potential difference between two points in the circuit



Try this

Material: copper and aluminium wires, glass rod, rubber

Method : Make connections as shown in figure 3.6. First connect a copper wire between points A and B and measure the current in the circuit. Then, in place of the copper wire, connect aluminium wire, glass rod, rubber, etc, one at a time and measure the current each time. Compare the values of the current in different cases.

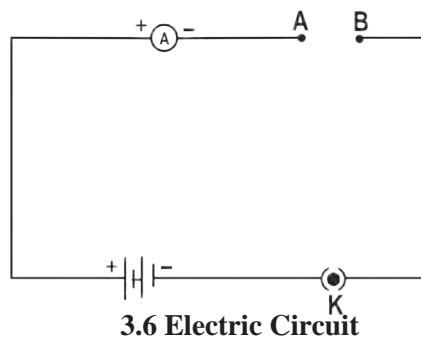

Conductors and insulators

We have learnt about the resistance to an electric current. We can divide substances into conductors and insulators (bad conductors).

Conductors : Those substances which have very low resistance are called conductors. Current can flow easily through such materials.

Insulators : Those substances which have extremely high resistance and through which current cannot flow are called insulators.

1. Why are some substances conductors while others are insulators?
2. Why can our body conduct electricity?

Make a list of conductors and insulators you see around you.

Experimental proof of Ohm's law :



Try this

Material : 4 cells of 1.5 V each, ammeter, voltmeter, conducting wires, nichrome wire, plug key.

Procedure :

1. Set up the circuit as shown in figure 3.7.
2. Use the nichrome wire XY as the resistance.
3. Connect one of the 4 cells as shown in figure 3.7 (a.) Take readings of ammeter and voltmeter and enter them in the table below.
4. Now add the rest of the cells one by one as shown in figures 3.7 (b, c and d). Enter the readings in the table for each case.
5. Determine the values of $\frac{V}{I}$ for each case.
6. Draw a graph between current and potential difference and study it.

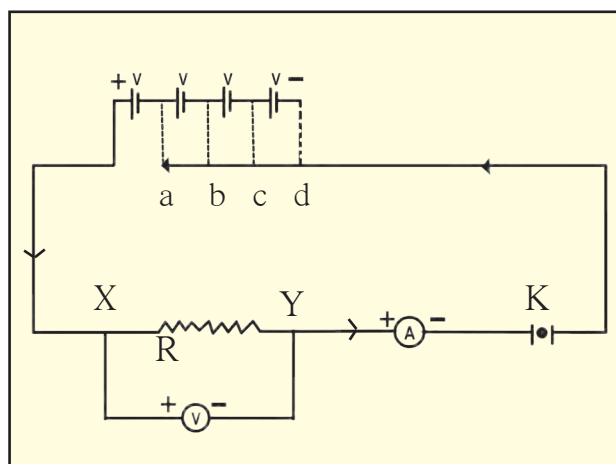

3.7 Verification of Ohm's Law

Observation chart

No.	Number of cells used	Current (I) (mA)	Current (I) (A)	Potential difference (Volts)	$V / I = R$ in (Ω)
1.					
2.					
3.					
4.					

Solved examples : Ohm's law and resistivity

Example 1 : The resistance of the filament in a light bulb is 1000Ω . If the bulb is fed by a current from a source of potential difference 230 V , how much current will flow through it?

Given : $R = 1000 \Omega$
 $V = 230 \text{ V}$

Formula $I = \frac{V}{R}$

$$\therefore I = \frac{230 \text{ V}}{1000 \Omega} = 0.23 \text{ A.}$$

\therefore The current flowing through the filament of the bulb = 0.23 A .

Example 2 : The length of a conducting wire is 50 cm and its radius is 0.5 mm . If its resistance is 30Ω , what is the resistivity of its material?

Given : $L = 50 \text{ cm} = 50 \times 10^{-2} \text{ m}$
 $r = 0.5 \text{ mm} = 0.5 \times 10^{-3} \text{ m}$
 $= 5 \times 10^{-4} \text{ m}$ and $R = 30 \Omega$
Resistivity $\rho = \frac{RA}{L}$
and $A = \pi r^2$

$$\begin{aligned}\therefore \rho &= R \frac{\pi r^2}{L} \\ &= \frac{30 \times 3.14 \times (5 \times 10^{-4})^2}{50 \times 10^{-2}} \\ &= \frac{30 \times 3.14 \times 25 \times 10^{-8}}{50 \times 10^{-2}} \\ &= 47.1 \times 10^{-6} \Omega \text{ m} \\ &= 4.71 \times 10^{-5} \Omega \text{ m}\end{aligned}$$

\therefore Resistivity of the wire $4.71 \times 10^{-5} \Omega \text{ m}$

Example 3 : A current of 0.24 A flows through a conductor when a potential difference of 24 V is applied between its two ends. What is its resistance?

Given : $V = 24 \text{ V}$, $I = 0.24 \text{ A}$

Formula $R = \frac{V}{I}$

$$\therefore I = \frac{24 \text{ V}}{0.24 \text{ A}}$$

$$R = 100 \Omega$$

The resistance of the conductor is 100Ω .

Example 4 : Determine the current that will flow when a potential difference of 33 V is applied between two ends of an appliance having a resistance of 110Ω . If the same current is to flow through an appliance having a resistance of 500Ω , how much potential difference should be applied across its two ends?

Given : $V = 33 \text{ V}$ and $R = 110 \Omega$

In the first case,

$$I = \frac{V}{R} = \frac{33}{110}$$

$$\therefore I = 0.3 \text{ A}$$

Current flowing through the appliance = 0.3 A

In the second case,

$$I = 0.3 \text{ A}, R = 500 \Omega$$

$$V = IR = 0.3 \times 500 \text{ V} = 150 \text{ V.}$$

The required potential difference between its two ends = 150 V

Using ICT

Using the internet find out about the different softwares used to solve mathematical problems and use them to solve problems given in this and other chapters.

Example 5 : Determine the resistance of a copper wire having a length of 1 km and diameter of 0.5 mm

Given : ρ = Resistivity of copper = $1.7 \times 10^{-8} \Omega \text{ m}$

Converting all measures into metres.

$$L = 1 \text{ km} = 1000 \text{ m} = 10^3 \text{ m}$$

$$d = 0.5 \text{ mm} = 0.5 \times 10^{-3} \text{ m}$$

If r is the radius of the wire then, its area of cross-section

$$A = \pi r^2$$

$$\therefore A = \pi \times \left(\frac{d}{2}\right)^2$$

$$= \frac{\pi}{4} (0.5 \times 10^{-3})^2 \text{ m}^2 = 0.2 \times 10^{-6} \text{ m}^2$$

$$R = \rho \frac{L}{A} = \frac{1.7 \times 10^{-8} \Omega \text{ m} \times (10^3 \text{ m})}{0.2 \times 10^{-6} \text{ m}^2} = 85 \Omega$$

System of resistors and effective resistance

A resistor is a two ended component having a given amount of resistance between its two ends. In several electrical devices, a number of resistors are connected together in different ways. Ohm's law is applicable to all such connected resistors.

Resistors in series

Study figure 3.8.

You can see that the ends of the three resistors are connected so that they follow one after the other in a single line. These resistors are said to be connected in 'series.' In such an arrangement, the same current flows through each resistor. The value of current is I and the potential difference between C and D is V .

The three resistors, R_1 , R_2 and R_3 are connected in series in the circuit. If V_1 , V_2 , V_3 are potential differences of every resistor R_1 , R_2 and R_3 respectively, then

$$V = V_1 + V_2 + V_3 \text{ -----(1)}$$

If R_s (S for series) is the effective resistance between C and D, then, according to Ohm's law,

$$V = I R_s$$

$V_1 = I R_1$, $V_2 = I R_2$ and $V_3 = I R_3$. Substituting all these in equation (1) we get,

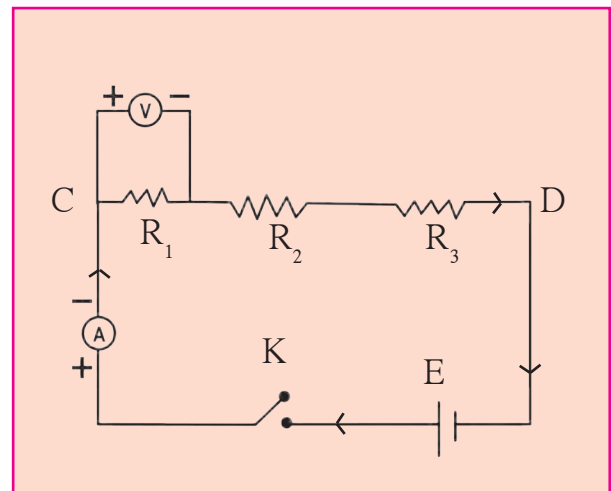

3.8 Resistors in series

$$I R_s = I R_1 + I R_2 + I R_3$$

$$R_s = R_1 + R_2 + R_3$$

If n resistors are connected in series then,

$$R_s = R_1 + R_2 + R_3 + \text{-----} + R_n$$

If resistors are connected in series,

1. The same current flows through each resistor.
2. The effective resistance of the resistors is equal to the sum of their individual resistances.
3. The potential difference between the two extremes of the arrangement is equal to the sum of the potential differences across individual resistors.
4. The effective resistance is larger than each of the individual resistances.
5. This arrangement is used to increase the resistance in a circuit.



Do you know?

When resistors are connected in series, they are connected one after another. If any one of them does not function, the circuit breaks and there is no flow of electricity. If two bulbs are connected in series, they will both give less light than if they had been connected individually. If three bulbs are connected in series, their light output will decrease further.

Think about it : What is the reason behind this?

Solved examples for resistors in series

Example 1 : Three resistors having resistances of 15Ω , 3Ω and 4Ω are connected in series. What is the effective resistance in the circuit?

Given : $R_1 = 15 \Omega$, $R_2 = 3 \Omega$, $R_3 = 4 \Omega$

Effective resistance $R_s = R_1 + R_2 + R_3 = 15 + 3 + 4 = 22 \Omega$

\therefore The effective resistance in the circuit = 22Ω

Example 2 : Two resistors having resistances of 16Ω and 14Ω are connected in series. If a potential difference of 18 V is applied across them, calculate the current flowing through the circuit and the potential difference across the end of each individual resistor.

Given : $R_1 = 16 \Omega$ and $R_2 = 14 \Omega$

$$R_s = 14 \Omega + 16 \Omega = 30 \Omega$$

Let the current flowing through the circuit be I and the potential differences across the end 16Ω and 14Ω be V_1 and V_2 respectively.

$$V = IR \quad V = V_1 + V_2 = 18 \text{ V}$$

$$I = \frac{V}{R} = \frac{18 \text{ V}}{30 \Omega}$$

$$\therefore I = 0.6 \text{ A.}$$

$$V_1 = IR_1$$

$$V_1 = 0.6 \times 16 = 9.6 \text{ V}$$

$$V_2 = IR_2 = 0.6 \times 14 = 8.4 \text{ V}$$

\therefore The current flowing in the circuit is 0.6 A and the potential differences across the end of the resistances 16Ω and 14Ω are 9.6 V and 8.4 V respectively.



Do you know?

The resistance of some conductors becomes nearly zero if their temperature is decreased upto a certain value close to 0 Kelvin (K). Such conductors are called super conductors.

Some conductors do not obey Ohm's law. Such conductors are called non-ohmic conductors.

Resistors in parallel

Resistors are said to be connected in parallel when their ends are connected at both sides as shown in figure 3.9. The figure shows three resistors R_1 , R_2 and R_3 connected in parallel between points C and D. V is the potential difference between C and D. Let I_1 , I_2 and I_3 be the currents flowing through R_1 , R_2 , and R_3 respectively.

Then, the total current flowing through the circuit is

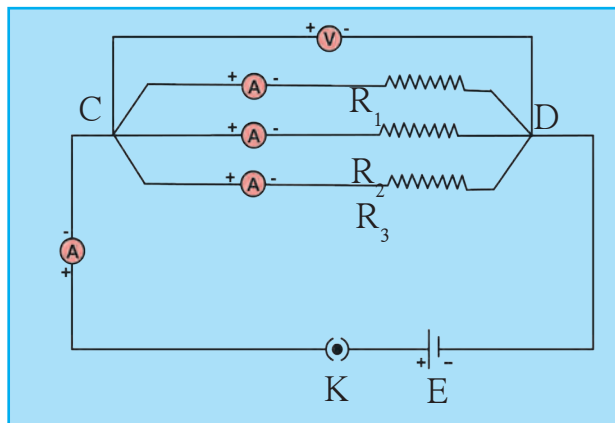

3.9 Resistors in parallel

$$I = I_1 + I_2 + I_3 \text{-----(1)}$$

Let R_p (p for parallel) be the effective resistance between C and D. According to Ohm's law,

$$I = \frac{V}{R_p} \quad \text{Similarly } I_1 = \frac{V}{R_1}, \quad I_2 = \frac{V}{R_2}, \quad I_3 = \frac{V}{R_3}$$

Substituting these in equation (1)

$$\begin{aligned} \frac{V}{R_p} &= \frac{V}{R_1} + \frac{V}{R_2} + \frac{V}{R_3} \\ \therefore \frac{1}{R_p} &= \frac{1}{R_1} + \frac{1}{R_2} + \frac{1}{R_3} \end{aligned}$$

If n resistors are connected in parallel,

$$\frac{1}{R_p} = \frac{1}{R_1} + \frac{1}{R_2} + \frac{1}{R_3} + \dots + \frac{1}{R_n}$$

Even if any one of the several bulbs connected in parallel becomes non-functional because of some damage to its filament, the circuit does not break as the current flows through the other paths, and the rest of the bulbs light up.

When several bulbs are connected in parallel, they emit the same amount of light as when they are connected individually in the circuit, while bulbs connected in series emit less light than when connected individually.

If a number of resistors are connected in parallel,

1. The inverse of the effective resistance is equal to the sum of the inverses of individual resistances.
2. The current flowing through an individual resistor is proportional to the inverse of its resistance and the total current flowing through the circuit is the sum of the currents flowing through individual resistors.
3. The potential difference across the end of all resistors is the same.
4. The effective resistance of resistors connected in parallel is less than the least resistance of individual resistors.
5. This arrangement is used to reduce the resistance in a circuit.

Solved examples of resistors in parallel

Example 1: Resistors having resistances of $15\ \Omega$, $20\ \Omega$ and $10\ \Omega$ are connected in parallel. What is the effective resistance in the circuit?

Given : $R_1 = 15\ \Omega$, $R_2 = 20\ \Omega$ and $R_3 = 10\ \Omega$

$$\frac{1}{R_p} = \frac{1}{R_1} + \frac{1}{R_2} + \frac{1}{R_3}$$

$$\frac{1}{R_p} = \frac{1}{15} + \frac{1}{20} + \frac{1}{10} = \frac{4 + 3 + 6}{60} = \frac{13}{60}$$

$$R_p = \frac{60}{13} = 4.615\ \Omega$$

\therefore Effective resistance in the circuit = $4.615\ \Omega$, less than the least of the three, $10\ \Omega$.

Example 2 : Three resistors having resistances of $5\ \Omega$, $10\ \Omega$ and $30\ \Omega$ are connected in parallel and a potential difference of $12\ \text{V}$ is applied across them. Obtain the current flowing through the circuit and through individual resistors. What is the effective resistance in the circuit?

Given : $R_1 = 5\ \Omega$, $R_2 = 10\ \Omega$ and $R_3 = 30\ \Omega$, $V = 12\ \text{V}$

$$I_1 = \frac{V}{R_1} = \frac{12}{5} = 2.4\ \text{A}$$

$$I_2 = \frac{V}{R_2} = \frac{12}{10} = 1.2\ \text{A}$$

$$I_3 = \frac{V}{R_3} = \frac{12}{30} = 0.4\ \text{A}$$

$$I = I_1 + I_2 + I_3 = 2.4 + 1.2 + 0.4 = 4.0\ \text{A}$$

$$\frac{1}{R_p} = \frac{1}{R_1} + \frac{1}{R_2} + \frac{1}{R_3} = \frac{1}{5} + \frac{1}{10} + \frac{1}{30} = \frac{6 + 3 + 1}{30} = \frac{10}{30} = \frac{1}{3}$$

Effective resistance in the circuit = $3\ \Omega$ and the current flowing through the resistances $5\ \Omega$, $10\ \Omega$ and $30\ \Omega$ is $2.4\ \text{A}$, $1.2\ \text{A}$ and $0.4\ \text{A}$ respectively. The total current flowing through the circuit is $4\ \text{A}$.

Domestic electrical connections

The electricity in our homes is brought through the main conducting cable either from the electric pole or from underground cables. Usually, there are three wires in the cable. One is called the live wire which brings in the current. It has a red or brown insulation. The other wire is called neutral wire through which the current returns. It is blue or black. In India, the voltage difference between the live and neutral wires is about 220V. Both these wires are connected to the electric meter through a fuse. Through a main switch, they are connected to all the conducting wires inside the home so as to provide electricity to every room. In each separate circuit, various electrical appliances are connected between the live and neutral wires. The different appliances are connected in parallel and the potential difference across every appliance is the same. The third wire is called the earth wire and is of yellow or green colour. This is connected to a metal plate buried deep underground near the house and is for safety purposes.

Fuse wire : Fuse wire is used to protect domestic appliances. It is made of a mixture of substances and has a specific melting point. It is connected in series to the electric appliances. If for some reason, the current in the circuit increases excessively, the fuse wire gets heated up and melts. The circuit gets broken and the flow of current stops, thus protecting the appliance. This wire is fitted in a groove in a body of porcelain - like non-conducting material. For domestic use, fuse wires with upper limits of 1 A, 2 A, 3 A, 4 A, 5 A and 10 A are used.

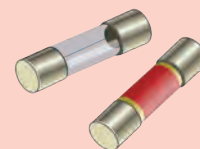

Cartridge fuse

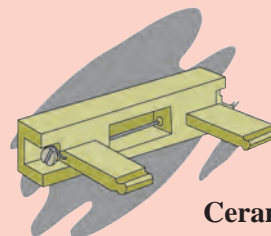

Ceramic fuse

Precautions to be taken while using electricity

1. Electric switches and sockets should be fitted at a height at which small children cannot reach and put pins or nails inside. Plug wires should not be pulled while removing a plug from its socket. Pull a plug.
2. Before cleaning an electrical appliance it should be switched off and its plug removed from the socket.
3. One's hands should be dry while handling an electrical appliance, and, as far as possible, one should use footwear with rubber soles. As rubber is an insulator, it prevents the current from flowing through our body, thereby protecting it.
4. If a person gets an electric shock, you should not touch that person. You should switch off the main switch and if the switch is too far or you do not know where it is located, then you should remove the plug from the socket if possible. If not, then you should use a wooden pole to push the person away from the electric wire.

Exercises



1. The accompanying figure shows some electrical appliances connected in a circuit in a house. Answer the following questions.

- By which method are the appliances connected?
- What must be the potential difference across individual appliances?
- Will the current passing through each appliance be the same? Justify your answer.
- Why are the domestic appliances connected in this way?
- If the T.V. stops working, will the other appliances also stop working? Explain your answer.

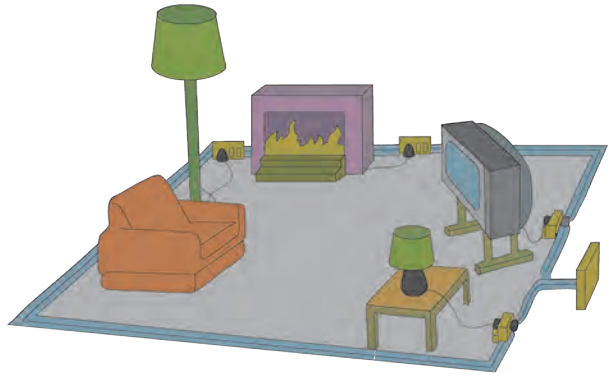

2. The following figure shows the symbols for components used in the accompanying electrical circuit. Place them at proper places and complete the circuit.

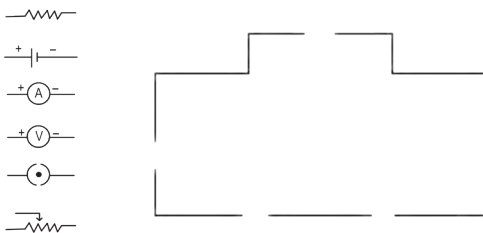

Which law can you prove with the help of the above circuit?

3. Umesh has two bulbs having resistances of $15\ \Omega$ and $30\ \Omega$. He wants to connect them in a circuit, but if he connects them one at a time the filament gets burnt. Answer the following.

- Which method should he use to connect the bulbs?
- What are the characteristics of this way of connecting the bulbs depending on the answer of question A above?

- What will be the effective resistance in the above circuit?

4. The following table shows current in Amperes and potential difference in Volts.

- Find the average resistance.
- What will be the nature of the graph between the current and potential difference? (Do not draw a graph.)
- Which law will the graph prove? Explain the law.

V (Volts)	I (Amp)
4	9
5	11.25
6	13.5

5. Match the pairs

'A' Group

- Free electrons
- Current
- Resistivity
- Resistances in series

'B' Group

- V/R
- Increases the resistance in the circuit
- Weakly attached
- VA/LI

6. The resistance of a conductor of length x is r . If its area of cross-section is a , what is its resistivity? What is its unit?
7. Resistances R_1 , R_2 , R_3 and R_4 are connected as shown in the figure. S_1 and S_2 are two keys. Discuss the current flowing in the circuit in the following cases.

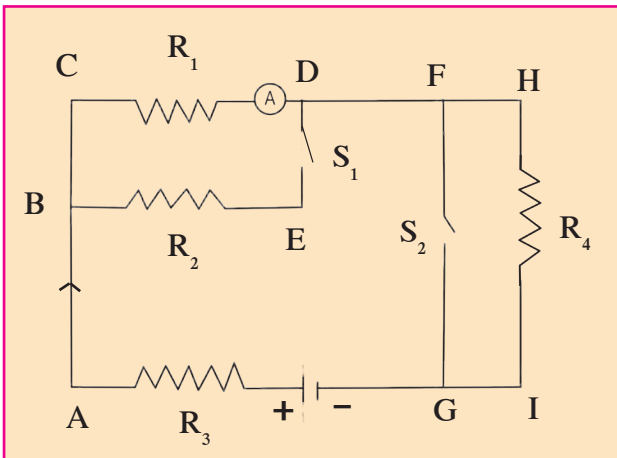

- Both S_1 and S_2 are closed.
 - Both S_1 and S_2 are open.
 - S_1 is closed but S_2 is open.
8. Three resistances x_1 , x_2 and x_3 are connected in a circuit in different ways. x is the effective resistance. The properties observed for these different ways of connecting x_1 , x_2 and x_3 are given below. Write the way in which they are connected in each case. (I-current, V-potential difference, x-effective resistance)
- Current I flows through x_1 , x_2 and x_3
 - x is larger than x_1 , x_2 and x_3
 - x is smaller than x_1 , x_2 and x_3
 - The potential difference across x_1 , x_2 and x_3 is the same
 - $x = x_1 + x_2 + x_3$
 - $x = \frac{1}{\frac{1}{x_1} + \frac{1}{x_2} + \frac{1}{x_3}}$

9. Solve the following problems.

- A. The resistance of a 1m long nichrome wire is 6Ω . If we reduce the length of the wire to 70 cm. what will its resistance be?
(Answer : 4.2Ω)
- B. When two resistors are connected in series, their effective resistance is 80Ω . When they are connected in parallel, their effective resistance is 20Ω . What are the values of the two resistances?
(Answer : 40Ω , 40Ω)
- C. If a charge of 420 C flows through a conducting wire in 5 minutes what is the value of the current?
(Answer : 1.4 A)

Project :

Ask an electrician to explain to you the electrical wiring in your house and other related important points. Take care to understand them well, and explain them to others also.



4. Measurement of Matter



- Laws of chemical combination ➤ Atom - shape, mass, valency
- Molecular mass and the concept of mole ➤ Radicals



Can you recall?

1. What is the Dalton's atomic theory ?
2. How are the compounds formed ?
3. What are the molecular formulae of common salt, slaked lime, water, lime, limestone ?

In the previous standard we have learnt that compounds are formed by chemical combination of elements. We have also learnt that an important principle of Dalton's atomic theory is that molecules of a compound are formed by joining atoms of different elements to each other.

Laws of chemical combination

The composition of a substance changes during a chemical change. The fundamental experiments in this regard were performed by scientists in the 18th and 19th century. While doing this, they measured accurately, the substances used and formed and discovered the laws of chemical combination. Scientists could then write the molecular formulae of various compounds on the basis of Dalton's atomic theory and the laws of chemical combination. Here we shall verify the laws of chemical combination by means of known molecular formulae.



Try this

Apparatus : Conical flask, test tubes, balance, etc.

Chemicals : Calcium chloride (CaCl_2), sodium sulphate (Na_2SO_4), calcium oxide (CaO), Water (H_2O)

Activity 1

- Take 56 g calcium oxide in a large conical flask and put 18 g water in it.
- Observe what happens.
- Measure the mass of the substance formed.
- What similarity do you find? Write your inference.

Activity 2

- Take a solution of calcium chloride in a conical flask and a solution of sodium sulphate in a test tube.
- Tie a thread to the test tube and insert it in the conical flask.
- Seal the conical flask with an airtight rubber cork.
- Weigh mass of the conical flask using a balance.
- Now tilt the conical flask so that the solution in the test tube gets poured in the conical flask.
- Now weigh mass of the conical flask again.
- Which changes did you notice? Was there any change in the mass?

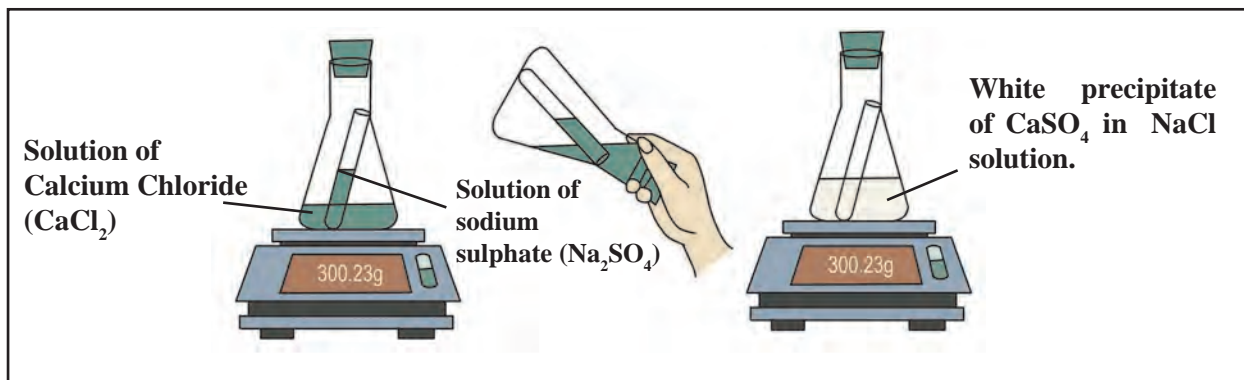

4.1 Verification of law of the chemical combination

Law of conservation of matter

In the above activities, the mass of the original matter and the mass of the matter newly formed as a result of the chemical change are equal. In 1785, the French Scientist Antoine Lavoisier inferred from his research that ‘there is no rise or drop in the mass of the matter during a chemical reaction.’ In a chemical reaction the total mass of the **reactants** is same as the total mass of the **products** formed due to the chemical reactions and this is called the law of conservation of matter.

Law of constant proportion

In 1794 the French scientist J. L. Proust stated the law of constant proportions as “The proportion by mass of the constituent elements in the different samples of a compound is fixed,” e.g., the proportion by mass of hydrogen and oxygen in water is obtained from any source 1:8. This means that 9 g water is formed by chemical combination of 1 g hydrogen and 8 g oxygen. Similarly, the proportion by mass of carbon and oxygen in carbon dioxide obtained from any source is 3:8. This means that in 44 g of carbon dioxide there is 12 g of carbon and 32 g of oxygen so that the proportion by mass of carbon and oxygen is 3:8.



Proust

Lavoisier

An introduction to scientists

Antoine Lavoisier (1743-94)

French scientist, father of modern chemistry, substantial contribution in the fields of chemistry, biology and economics.

- Nomenclature of oxygen and hydrogen.
- Showed that matter combines with oxygen during combustion.
- Was the first to use accurate weighing techniques to weigh mass of reactants and products in a chemical reaction.
- Discovered that water is made up of hydrogen and oxygen.
- First writer of the law of conservation of mass, in a chemical reaction.
- Assigned systematic names to the compounds, e.g. sulphuric acid, copper sulphate, sulphite.
- Authored the first book on modern chemistry- ‘Elementary Treatise on Chemistry in 1789.’
- Studied the elements such as oxygen, hydrogen, nitrogen, phosphorus, mercury, zinc and sulphur.

Verification of the law of constant proportion

Many compounds can be made by different methods. For example, two samples of the compound copper oxide, CuO, were obtained, one by decomposition of copper carbonate, CuCO_3 , and another by decomposition of copper nitrate, $\text{Cu}(\text{NO}_3)_2$. From each of these samples, a mass of 8g of copper oxide was taken and each was treated independently with hydrogen gas. Both gave 6.4 g copper and 1.8 g water. Let us see how does this is a verification of the law of constant proportion.

The reaction of copper oxide with hydrogen yielded two known substances, namely, the compound water and the element copper. It is known that, in the compound water, H_2O , the elements H and O are in the proportion 1:8 by mass. This means that in 9g water there are 8g of the element oxygen. Therefore, 1.8g water contains $(8 \times 1.8 / 9 = 1.6)\text{g}$ oxygen. This oxygen has come from 8g copper oxide. It means that 8g of both the samples of copper oxide contained 6.4g copper and 1.6g oxygen; and the proportion by mass of copper and oxygen in it is 6.4:1.6, that is, 4:1. Thus, the experiment showed that the proportion by mass of the constituent elements in different samples of a compound is constant.

Now let us see what the expected proportion by mass of the constituent elements of copper oxide would be from its known molecular formula CuO. To find out this, we need to use the known atomic masses of the elements. The atomic masses of Cu and O are 63.5 and 16 respectively. This means that the proportion by mass of the constituent elements Cu and O in the compound CuO is 63.5 : 16 which is 3.968:1, or approximately 4:1.

The experimental value of proportion by mass of the constituent elements matched with the expected proportion calculated from the molecular formula. Thus, the law of constant proportion is verified.

Atom : size, mass and valency



Can you recall?

1. From which experiments was it discovered that atoms have an internal structure? When?
2. What are the two parts of an atom? What are they made up of?

We have learnt that at the centre of an atom is the nucleus and that there are moving electrons in the extra-nuclear part. The electrons are negatively charged elementary particles while the elementary particles that make up the nucleus are positively charged protons and electrically neutral neutrons.

The size of an atom is determined by its radius. The atomic radius of an isolated atom is the distance between the nucleus of an atom and its outermost orbit. Atomic radius is expressed in nanometres.

Approximate size of atom and Molecule

Atomic radius (in metres)	Example
10^{-10}	Hydrogen atom
10^{-9}	Water molecule
10^{-8}	Haemoglobin molecule

$$\frac{1}{10^9} \text{ m} = 1 \text{ nm}$$
$$1 \text{ m} = 10^9 \text{ nm.}$$

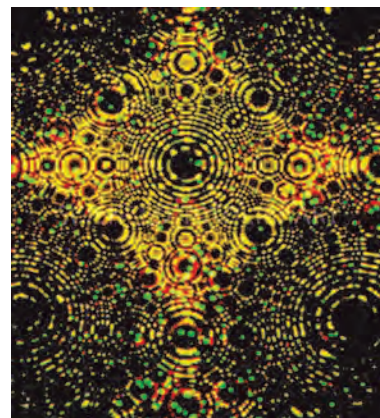

4.2 Field ion microscope image of iridium atoms (every spot in this image is an atom)

Atoms are very tiny. Modern instruments like electron microscope, field ion microscope, scanning tunneling microscope enlarged images of the atom. Look at the image of an atom fig. 4.2 obtained with a field ion microscope.

The atomic size depends on the number of electron orbits in the atom. The greater the number of orbits the larger the size. For example, an atom of K is bigger than an atom of Na. If two atoms have the same outermost orbit, then the atom having the larger number of electrons in the outermost orbit is smaller than the one having fewer electrons in the same outermost orbit. For example an atom of Mg is smaller than an atom of Na.

The mass of an atom

The mass of an atom is concentrated in its nucleus and it is due to the protons (p) and neutrons (n) in it. The total number (of protons and neutrons) in the atomic nucleus is called the **atomic mass number**. Protons and neutrons are together called **nucleons**.

An atom is very tiny. Then how do we determine its mass? Scientists too, faced this question. It was not possible for scientists of the 19th century to measure atomic mass accurately. Therefore, the concept of 'relative mass of an atom' was put forth. A reference atom was required for expressing the relative mass of an atom. The hydrogen atom being the lightest was initially chosen as the reference atom. The relative mass of a hydrogen atom which has only one proton in its nucleus was accepted as one (1). Therefore, the magnitude of the relative atomic masses of various atoms became equal to their atomic mass number (p+n).

Let us see how to express the relative mass of a nitrogen atom, having accepted the relative atomic mass of hydrogen as 1.

The mass of one nitrogen atom is fourteen (14) times that of a hydrogen atom. Therefore, the relative mass of a nitrogen atom is 14. This is how the relative atomic masses of various elements were determined. On this scale, the relative atomic masses of many elements came out to be fractional. Therefore, in the course of time, some other atoms were chosen as reference atoms. Finally in 1961, the carbon atom was selected as the reference atom. In this scale, the relative mass a carbon atom was accepted as 12. The relative atomic mass of one hydrogen atom compared to the carbon atom becomes $12 \times 1/12$, that is 1. The mass of one proton and of one neutron on the scale of relative atomic masses is approximately one.



Research

The relative atomic masses of some elements in the chart below are given. You have to find the relative atomic masses of the others.

Element	Atomic mass	Element	Atomic mass	Element	Atomic mass
Hydrogen	1	Oxygen	-	Phosphorus	-
Helium	4	Fluorine	19	Sulphur	32
Lithium	7	Neon	20	Chlorine	35.5
Beryllium	9	Sodium	-	Argon	-
Boron	11	Magnesium	24	Potassium	-
Carbon	12	Aluminium	-	Calcium	40
Nitrogen	14	Silicon	28		

Today, we have highly accurate methods for measuring the mass of an atom directly. Hence, instead of relative mass, Unified Mass has now been accepted as the unit of atomic mass. It is called Dalton. Its symbol is 'u'. $1\text{u} = 1.66053904 \times 10^{-27}\text{ kg}$

Chemical symbols of elements



Can you tell?

1. How is an element represented in Chemistry?
2. Write down the symbols of the elements you know.
3. Write down the symbols for the following elements : antimony, iron, gold, silver, mercury, lead, sodium.

Dalton used certain signs to represent elements. For example \odot for hydrogen, \textcircled{C} for copper. Today we use the symbols determined by IUPAC (International Union of Pure and Applied Chemistry). These are official names and symbols and are used all over the world. The current method of choosing chemical symbols is based on the method invented by Berzelius. According to this method the symbol of an element is either the first letter or the first and second/another specific letter in its name. Of the two letters, the first is written as capital letter and the second is small.

Molecules of elements and compounds

Atoms of some elements such as helium, neon have independent existence. It means that these elements are in a mono-atomic molecular state. Sometimes, two or more atoms of an element combine to form molecules of that element. Such elements are in a poly-atomic molecular state. For example, the elements oxygen, nitrogen are in a diatomic molecular state as O_2 , N_2 respectively. When atoms of different elements combine with each other, the molecules of compounds are formed. In other words, compounds are formed by chemical attraction between different elements.



Make a list and discuss

Make a list of elements that exist in mono-atomic and diatomic molecular states.

Molecular mass and the concept of mole

Molecular mass

The molecular mass of a substance is the sum of the atomic masses of all the atoms in a single molecule of that substance. Like atomic mass, molecular mass is also expressed in the unit Dalton (u).

How to deduce the molecular mass of H_2O ?

Molecule	Constituent elements	Atomic mass u	Number of atoms in the molecule	Atomic mass \times number of atoms	Mass of the constituents u
H_2O	Hydrogen	1	2	1×2	2
	Oxygen	16	1	16×1	16
Molecular mass = sum of constituent atomic masses (Molecular mass of H_2O) = (Atomic mass of H) \times 2 + (Atomic mass of O) \times 1					Molecular Mass 18



Use your brain power !

Following are atomic masses of a few elements in Dalton and the molecular formulae of some compounds. Deduce the molecular masses of those compounds.

Atomic masses → H(1), O(16), N(14), C(12), K(39), S(32) Ca(40), Na(23), Cl(35.5), Mg(24), Al(27)

Molecular formulae → NaCl, MgCl₂, KNO₃, H₂O₂, AlCl₃, Ca(OH)₂, MgO, H₂SO₄, HNO₃, NaOH

Mole



Try this

1. Weigh mass of single grains of *tur dal*, *masoor dal* and *chana dal* on a balance. What was your experience?
2. Weigh mass of 10g of *Tur dal*, *Masoor dal* and *Chana dal* each and count the number of *dal* grains of each kind in the weighed portions. Is the number the same for all or different?
3. Draw a line sketch on a paper. Paint it by placing/pasting the *dal* grains in the sequence *Tur*, *Masoor* and Bengal gram. You will need equal number of *dal*-grains of the three kinds. Count that number and also find out how many dozens of the respective *dal*-grains were required. Therefrom deduce the number of grams of *tur dal*, *masoor dal* and *chana dal* required for painting the picture.
4. What inference will you draw about the mass of an equal number of its different *dal* grains and the number of its *dal* grains in equal mass of different *dals*?



Think about it

How much of wheat, jowar and bajra seed is required for sowing one acre of land? Can these masses be correlated to the number of grains of the respective cereals they contain?



Can you tell?

1. Is it possible to weigh mass of one molecule using a weighing balance?
2. Will the number of molecules be the same in equal quantities of different substances?
3. If we want equal number of molecules of different substances, will it work to take equal masses of those substances?

When elements and compounds take part in chemical reactions, it is their atoms and molecules that react with each other, and therefore it is necessary to know the numbers of their atoms and molecules. However, while carrying out a chemical reaction it, is convenient to measure out quantities that can be handled instead of counting the numbers of atoms and molecules. The concept of 'mole' is useful for this purpose.

A mole is that quantity of a substance whose mass in grams is equal in magnitude to the molecular mass of that substance in Daltons. Thus, the molecular mass of oxygen is 32u, and therefore 32g oxygen is 1mole of oxygen. The molecular mass of water is 18u. Therefore, 18g of water make 1 mole of water.

1 mole of a compound is the mass of that substance in grams equal in magnitude to its molecular mass. The SI unit is mol.

$$\text{Number of moles of a substances (n)} = \frac{\text{Mass of substance in grams}}{\text{Molecular mass of substance}}$$

Avogadro's number

The number of molecules in one mole of any substance is constant. The Italian scientist Avogadro did fundamental work in this context. Therefore this number is called Avogadro's number and is denoted by the symbol N_A . Later scientists demonstrated experimentally that the value of Avogadro's number is 6.022×10^{23} . A mole of any substance stands for 6.022×10^{23} molecules. Just as a dozen has 12 items, a century has 100 or a gross has 144, a mole means 6.022×10^{23} . For example, a mole of water, that is, 18g of water contains 6.022×10^{23} molecules of water.

How many molecules are there in 66 g of CO_2 ?





Method : molecular mass of CO_2 is 44.

$$\text{Number of moles in the given } \text{CO}_2 (n) = \frac{\text{Mass of } \text{CO}_2 \text{ in grams}}{\text{Molecular mass of } \text{CO}_2} = \frac{66}{44}$$

$\therefore n = 1.5 \text{ mol}$

$\therefore 1 \text{ mol of } \text{CO}_2 \text{ contains } 6.022 \times 10^{23} \text{ molecules.}$

$\therefore 1.5 \text{ mol } \text{CO}_2 \text{ contains } 1.5 \times 6.022 \times 10^{23} \text{ molecules} = 9.033 \times 10^{23} \text{ molecules}$

<p>1 dozen bananas are 12 bananas</p> 	<p>144 notebooks make 1 gross of note books</p> 		<p>1 mole common salt = 6.022×10^{23} molecules</p> 
<p>1 mole water = 6.022×10^{23} molecules</p>			

4.3 One mole (Avogadro number)



Use your brain power !

1. How many molecules of water are there in 36g water?
2. How many molecules of H_2SO_4 are there in a 49g sample?



Always remember

1. The number of molecules in a given quantity of a substance is determined by its molecular mass.
2. The number of molecules in equal masses of different substances are different.
3. One mole quantities of different substances have different masses measured in grams.

Valency



Can you recall?

1. Determine the valencies of H, Cl, O and Na from the molecular formulae H_2 , HCl, H_2O and NaCl.
2. What is the type of chemical bond in NaCl and $MgCl_2$?

The capacity of an element to combine is called its valency. The valency of an element is indicated by a specific number. It is the number of chemical bonds formed by one atom of that element with other atoms. In the 18th and 19th century, the laws of chemical combination were used to find out the valencies of elements. In 20th century, the relationship of the valency of an element with its electronic configuration was recognised.

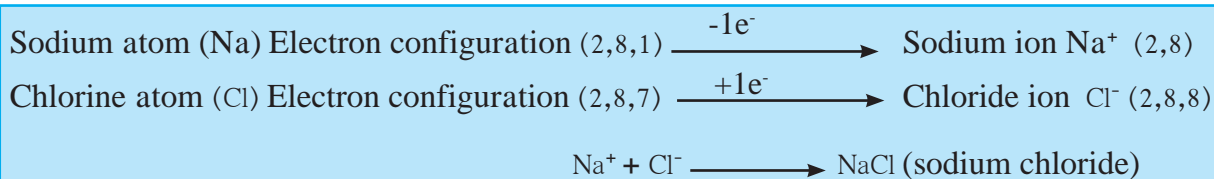

A sodium atom gives away one electron and a cation of sodium is formed, hence, the valency of sodium is one. A chlorine atom takes up one electron and forms an anion of chlorine (chloride) and thus, the valency of chlorine is 1. After the give and take of electrons is over, the electronic configuration of both the resulting ions has a complete octet. Due to the attraction between the unit opposite charges on the two ions, one chemical bond is formed between Na^+ and Cl^- and the compound NaCl is formed.

Thus, a sodium atom has the capacity to give away one electron while a chlorine atom has the capacity to take up one electron. This means that the valency of both the elements sodium and chlorine is 1. From this the electronic definition of valency is as follows : “The number of electrons that an atom of an element gives away or takes up while forming an ionic bond, is called the valency of that element.”

Science capsule

Positively charged ions are called **cations** while negatively charged ions are called **anions**. For example, $MgCl_2$ contains Mg^{++} and Cl^- as cation and anion respectively.

The electrons present in the outermost orbit of an atom are called valence electrons.



Use your brain power !

How will the compounds, $MgCl_2$ and CaO be formed their elements?

The number of electrons that are given away or taken up is always a whole number. Therefore, valency is always a whole number.

The National Chemical Laboratory (NCL), a unit of the CSIR, was established in 1950. Its objectives are to conduct research in the various branches of chemistry, to aid industry and to develop new technology with a view to making profitable use of the country's natural resources. The Laboratory conducts research in fields such as biotechnology, nanotechnology, catalysis, drugs, instrumentation, agro chemicals, plant tissue culture and polymer science.

Complete the following chart.

Element	Atomic number	Electron configuration	Valence electrons	Valency
Hydrogen	1	1	1	1
Helium	2	2	2	0
Lithium	2,1
Beryllium	4	2
Boron	5	2,3
Carbon	2,4	4
Nitrogen	7	3
Oxygen	2,6	6
Fluorine	9	7
Neon	10
Sodium	2,8,1	1	1
Magnesium	12	2
Aluminium	13	2,8,3
Silicon	14	4

Some elements that exhibit variable valency

Element	Symbol	Valency	Ion	Nomenclature
Copper	Cu	1 and 2	Cu ⁺ Cu ²⁺	Cuprous Cupric
Mercury	Hg	1 and 2	Hg ⁺ Hg ²⁺	Mercurous Mercuric
Iron	Fe	2 and 3	Fe ²⁺ Fe ³⁺	Ferrous Ferric

Radicals



Complete the table.

Write down the cations and anions obtained from the compounds in the following chart.

Base	Cation	Anion	Acid	Cation	Anion
NaOH			HCl		
KOH			HBr		
Ca(OH) ₂			HNO ₃		

Variable valency

Under different conditions the atoms of some elements give away or take up different numbers of electrons. In such cases those elements exhibit more than one valency. This property of elements is called variable valency.



Always remember

Iron (Fe) exhibits the variable valencies 2 and 3. Therefore iron forms two compounds with chlorine FeCl₂ and FeCl₃.



Research

1. Find out some more elements which have variable valency.
2. Find out the compounds of the above elements which have variable valency.

Compounds with ionic bonds have two constituents. These are cations (positively charged ions) and anions (negatively charged ion). They take part independently in chemical reaction and are therefore, called radicals. It is seen from the above chart that different bases such as NaOH, KOH are formed when various cationic radicals are paired with the different anionic radical, hydroxide. Hence the cationic radicals are also called basic radicals. Different bases are distinguished from each other by the basic radicals in them. On the other hand, different acids, such as HCl, HBr are formed when different anionic radicals are paired with the cationic radical H^+ . Therefore, the anionic radicals are called acidic radicals. The difference in the composition of various acids becomes clear from the acidic radicals present in them.



Can you tell?

Which are the basic radicals and which are the acidic radicals among the following?

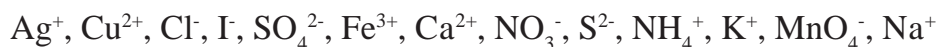

Generally, basic radicals are formed by removal of electrons from the atoms of metals, such as Na^+ , Cu^{2+} . But there are some exceptions, such as NH_4^+ . Similarly, the acidic radicals are formed by adding electrons to the atoms of non-metals, such as Cl^- , S^{2-} . But there are some exceptions like MnO_4^- .



Use your brain power !

Classify the following radicals into two types. While doing this use a criterion other than the sign of the electronic charge on them.

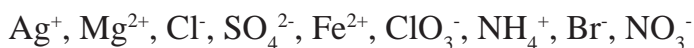

Monoatomic radicals such as Na^+ , Cu^+ , Cl^- are called simple radicals. When a radical is a group of atoms carrying charge, such as SO_4^{2-} , NH_4^+ , it is called composite radical. The magnitude of charge on any radical is its valency.

Chemical formulae of compounds : A recapitulation.

The characteristic of a compound formed by ionic bonds is that its molecule has two parts. These are a cation and an anion, that is, a basic radical and an acidic radical. These two parts are oppositely charged. The force of attraction between them constitutes the ionic bond. The name of an ionic compound contains two words. The first word is the name of the cation and the second is the name of the anion. For example, the formula of a compound such as sodium chloride is written by writing the symbol of the cation on the left and adjoined to it on the right is the symbol of the anion. The charges are not shown though the number of the ions is written as a subscript on the right of the symbol of the ion. In the case of composite radical the number is written as subscript outside the bracket enclosing its symbol. This number is obtained easily by the method of cross multiplication of the valencies. The steps for writing a chemical formula are shown on the next page.

Using ICT

To study 'Measurement of Matter' further and for additional information, visit the websites given alongside.

Prepare a spreadsheet showing the atomic mass of elements, molecular masses, electronic configurations and valencies.

Website for more information

www.organic.chemistry.org

www.masterorganicchemistry.com

www.rsc.org.learnchemistry

Step 1 : To write the symbols of the radicals. (Basic radical on the left.)



Step 2 : To write the valency below the respective radical.



Step 3 : To cross-multiply as shown by the arrows the number of the radicals.

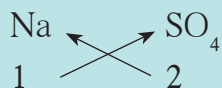

Step 4 : To write down the chemical formula of the compound.



In order to write the chemical formulae of compounds, it is necessary to know the valency of the various radicals. The names and symbols along with the charge of common radicals are given in the chart below.

Ions/Radicals

Basic Radicals				Acidic Radicals			
H ⁺	Hydrogen	Al ³⁺	Aluminium	H ⁻	Hydride	MnO ₄ ⁻	Permanganate
Na ⁺	Sodium	Cr ³⁺	Chromium	F ⁻	Fluoride	ClO ₃ ⁻	Chlorate
K ⁺	Potassium	Fe ³⁺	Ferric	Cl ⁻	Chloride	BrO ₃ ⁻	Bromate
Ag ⁺	Silver	Au ³⁺	Gold	Br ⁻	Bromide	IO ₃ ⁻	Iodate
Hg ⁺	Mercurous	Sn ⁴⁺	Stannic	I ⁻	Iodide	CO ₃ ²⁻	Carbonate
Cu ⁺	Cuprous	NH ₄ ⁺	Ammonium	O ²⁻	Oxide	SO ₄ ²⁻	Sulphate
Cu ²⁺	Cupric/Copper			S ²⁻	Sulphide	SO ₃ ²⁻	Sulphite
Mg ²⁺	Magnesium			N ³⁻	Nitride	CrO ₄ ²⁻	Chromate
Ca ²⁺	Calcium					Cr ₂ O ₇ ²⁻	Dichromate
Ni ²⁺	Nickel			OH ⁻	Hydroxide	PO ₄ ³⁻	Phosphate
Co ²⁺	Cobalt			NO ₃ ⁻	Nitrate		
Hg ²⁺	Mercuric			NO ₂ ⁻	Nitrite		
Mn ²⁺	Manganese			HCO ₃ ⁻	Bicarbonate		
Fe ²⁺	Ferrous (Iron II)			HSO ₄ ⁻	Bisulphate		
Sn ²⁺	Stannous			HSO ₃ ⁻	Bisulphite		
Pt ²⁺	Platinum						



Books are my friends

Essentials of Chemistry, The Encyclopedia of Chemistry, Science and Technology Dictionary.



Use your brain power !

Using the chart of ions/radicals and the cross-multiplication method, write the chemical formulae of the following compounds : Calcium carbonate, Sodium

bicarbonate, Silver chloride, Calcium hydroxide, Magnesium oxide, Ammonium phosphate, Cuprous bromide, Copper sulphate, Potassium nitrate, Sodium dichromate.

Exercises



1. Give examples.

- Positive radicals
- Basic radicals
- Composite radicals
- Metals with variable valency
- Bivalent acidic radicals
- Trivalent basic radicals

2. Write symbols of the following elements and the radicals obtained from them, and indicate the charge on the radicals.

Mercury, potassium, nitrogen, copper, sulphur, carbon, chlorine, oxygen

3. Write the steps in deducing the chemical formulae of the following compounds.

Sodium sulphate, potassium nitrate, ferric phosphate, calcium oxide, aluminium hydroxide

4. Write answers to the following questions and explain your answers.

- Explain the monovalency of the element sodium.
- M is a bivalent metal. Write down the steps to find the chemical formulae of its compounds formed with the radicals : sulphate and phosphate
- Explain the need for a reference atom for atomic mass. Give some information about two reference atoms.
- What is meant by Unified Atomic Mass?
- Explain with examples what is meant by a 'mole' of a substance.

5. Write the names of the following compounds and deduce their molecular masses.

Na_2SO_4 , K_2CO_3 , CO_2 , MgCl_2 , NaOH , AlPO_4 , NaHCO_3

6. Two samples 'm' and 'n' of slaked lime were obtained from two different reactions. The details about their composition are as follows:

'sample m' mass : 7g

Mass of constituent oxygen : 2g

Mass of constituent calcium : 5g

'sample n' mass : 1.4g

Mass of constituent oxygen : 0.4g

Mass of constituent calcium : 1.0g

Which law of chemical combination does this prove? Explain.

7. Deduce the number of molecules of the following compounds in the given quantities.

32g oxygen, 90g water, 8.8g carbon dioxide, 7.1g chlorine.

8. If 0.2 mol of the following substances are required how many grams of those substances should be taken?

Sodium chloride, magnesium oxide, calcium carbonate

Project :

Prepare models of various radicals using cardboard, small circular magnets and araldite. From these make models of molecules of various compounds.



5. Acids, Bases and Salts



➤ Arrhenius theory of acids and bases ➤ Concentration of an acid or a base
➤ pH of a solution ➤ pH of an acid and a base ➤ Salts



Can you recall?

How are the following substances classified into three groups with the help of litmus? Lemon, tamarind, baking soda, buttermilk, vinegar, orange, milk, lime, tomato, milk of magnesia, water, alum.

We have seen earlier that some foodstuffs are sour to taste while some others are bitter and slippery or soapy to touch. When these substances are studied scientifically, it is found that they contain acidic and basic substances respectively. We have also learnt about an easy and safe method of using an indicator like litmus to detect acids and bases.

How are acids and alkalies detected with the help of litmus paper?

We shall now learn more about acids and bases. But let us first recapitulate on the constituents of molecules of compounds.

Fill in the columns in the part 'A' of the following table.

Name of the compound	A			B
	Molecular formula	Basic radical	Acidic radical	Type of the compound
Hydrochloric acid	HCl	H ⁺	Cl ⁻	Acid
	HNO ₃			
	HBr			
	H ₂ SO ₄			
	H ₃ BO ₃			
	NaOH			
	KOH			
	Ca(OH) ₂			
	NH ₄ OH			
	NaCl			
	Ca(NO ₃) ₂			
	K ₂ SO ₄			
	CaCl ₂			
	(NH ₄) ₂ SO ₄			

Some compounds are seen to have H⁺ as the basic radical in their molecules. These are all acids. Some compounds are seen to have OH⁻ as the acidic radical in their molecules. All these compounds are bases. These ionic compounds having basic radicals other than H⁺ and acidic radicals other than OH⁻ are called salts.

Now complete part 'B' of the table on page 58. It will be clear that there are three types of ionic compounds and these are acids, bases and salts.

Ionic compounds : A recapitulation

The molecule of an ionic compound has two constituents, namely, cation (positive ion/basic radical) and anion (negative ion/acidic radical). There is a force of attraction between these ions as they are oppositely charged, and that is called the ionic bond. The force of attraction between one positive charge on a cation and one negative charge on an anion makes one ionic bond.

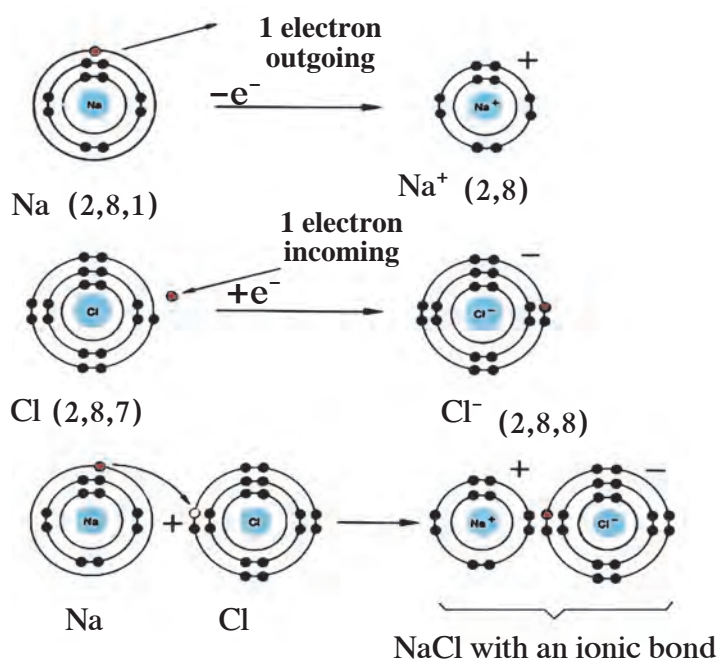

While studying static electricity we have learnt that there is a natural tendency of any body to change from an electrically charged state into an electrically neutral state. Why, then, is an electrically charged ion formed from an electrically balanced, that is, neutral atom? The explanation lies in the electronic configuration of atoms. Figure 5.1 shows how the sodium and chlorine atoms form the Na^+ and Cl^- and as a result, how the NaCl salt is formed.

5.1 Formation of the compound NaCl Electronic configuration

The outermost shell of a sodium and a chlorine atoms is not a complete octet. However outermost shells in both the Na^+ and Cl^- ions are complete octet.

An electronic configuration with a complete octet indicates a stable state. Further, an ionic bond is formed between the oppositely charged Na^+ and Cl^- ions and therefore an ionic compound NaCl having very high stability is formed.

Dissociation of ionic compounds



Can you recall?

What are the resulting mixtures formed by mixing the following substances?

1. Water and salt
2. Water and sugar
3. Water and sand
4. Water and sawdust

An ionic compound forms an aqueous solution on dissolving in water. In the solid state, the oppositely charged ions in the ionic compound are sitting side by side. When an ionic compound begins to dissolve in water, the water molecules penetrate in between the ions of the compound and separate them from each other. That is to say, an ionic compound dissociates during formation of an aqueous solution. (See figure 5.2)

Each of the dissociated ions in the aqueous solution is surrounded by water molecules. This state is indicated by writing (aq), meaning aqueous, on the right of the symbol of the ion.



5.2 Dissociation of salt in aqueous solution

Arrhenius theory of acids and bases

The Swedish scientist Arrhenius put forth a theory of Acids and Bases in the year 1887. This theory gives definitions of acids and bases as follows :

Acid : An acid is a substance which on dissolving in water gives rise to H^+ ion as the only cation. For example, HCl , H_2SO_4 , H_2CO_3 .

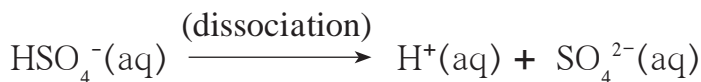
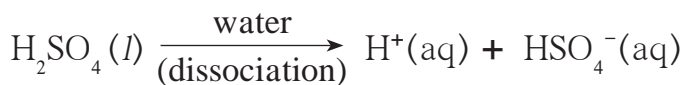
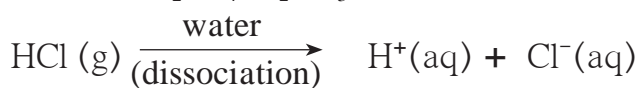

Use your brain power !

1. What are the names of the following compounds?
 NH_3 , Na_2O , CaO .
2. When the above compounds are mixed with water they combine with water. Complete the following table by showing the ions formed by their combination with water.
3. Into which type will you classify the above compounds-acid, base or salt ?

$\text{NH}_3(\text{g}) + \text{H}_2\text{O}(\text{l})$	\longrightarrow	$\text{NH}_4^+(\text{aq}) + \text{OH}^-(\text{aq})$
$\text{Na}_2\text{O}(\text{s}) + \dots\dots\dots$	\longrightarrow	$2 \text{Na}^+(\text{aq}) + \dots\dots\dots$
$\text{CaO}(\text{s}) + \text{H}_2\text{O}(\text{l})$	\longrightarrow	$\dots\dots\dots + \dots\dots\dots$

Base : A base is a substance which on dissolving in water gives rise to the OH⁻ ion as the only anion. For example, NaOH, Ca(OH)₂.

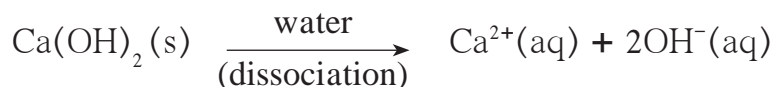
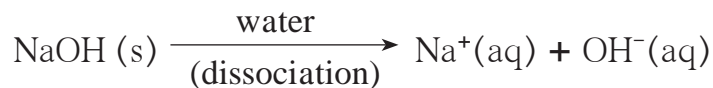

Classification of acids and bases

1. Strong and weak acids, bases and alkali

1. Acids and bases are classified as strong and weak on the basis of the extent to which they dissociate in their aqueous solutions.

Strong acid : On dissolving in water, a strong acid dissociates almost completely and the resulting aqueous solution contains mainly H⁺ ions and the concerned acidic radical. For example, HCl, HBr, HNO₃, H₂SO₄.

Weak acid : On dissolving in water a weak acid does not dissociate completely. The resulting aqueous solution contains H⁺ ion and the concerned acidic radical in small proportion along with large proportion of the undissociated molecules of the acid. For example, CH₃COOH (Acetic Acid), CO₂.

Strong base : On dissolving in water, a strong base dissociates almost completely and the resulting aqueous solution contains mainly OH⁻ ions and the concerned basic radicals. For example, NaOH, KOH, Ca(OH)₂, Na₂O.

Weak base : On dissolving in water a weak base does not dissociate completely. The resulting aqueous solution contains a small proportion of OH⁻ ions and the concerned basic radical along with a large proportion of undissociated molecules of the base. For example, NH₃.

Alkali : The bases which are highly soluble in water are called alkali. For example, NaOH, KOH, NH₃. Here, NaOH and KOH are strong bases while NH₃ is a weak base.

2. Basicity and acidity

Complete the following table.

Acid : Number of H ⁺ obtained from one molecule.						
HCl	HNO ₃	H ₂ SO ₄	H ₂ CO ₃	H ₃ BO ₃	H ₃ PO ₄	CH ₃ COOH
Base : Number of OH ⁻ ions obtained from one molecule						
NaOH	KOH	Ca(OH) ₂	Ba(OH) ₂	Al (OH) ₃	Fe(OH) ₃	NH ₄ OH

Acids and bases are also classified according to their basicity and acidity respectively.

Basicity of acids : The number of H^+ ions obtainable by the dissociation of one molecule of an acid is called its basicity.

Acidity of bases : The number of OH^- ions obtainable by the dissociation of one molecule of a base is called its acidity.



Use your brain power !

1. Refer to the table on page no. 61 and give examples of monobasic, dibasic and tribasic acids.
2. Refer to the table on page no. 61 and give the three types of bases and their examples.

Concentration of acid and base



Try this

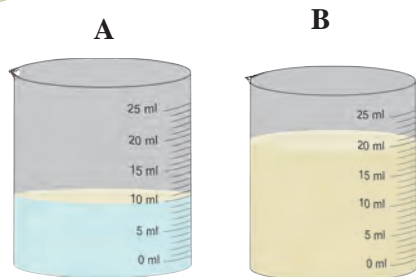

5.3 Solution of lemon juice

Cut a lemon into two equal parts. Take the juice of each part into two separate beakers. Pour 10ml of drinking water in one beaker and 20ml in the second. Stir the solutions in both the beakers and taste them. Is there any difference in the tastes of the solutions in the two beakers? What is it?

In the above activity, the sour taste of the solutions is because of the solute, lemon juice, in them. The quantity of the lemon juice is the same in both the solutions. Yet their taste is different. The solution in the first beaker is more sour than the one in the second. Why is it so?

Although the quantity of the solute is the same in both the solutions, the quantity of the solvent is different. Ratio of the quantity of the solute to the quantity of the resulting solution is different. This ratio is larger for the solution in the first beaker and, therefore, that solution tastes more sour. On the other hand, the proportion of the lemon juice to the total solution in the second beaker is smaller and the taste is less sour.

The taste of foodstuff depends upon the nature of the taste-giving ingredient and its proportion in the foodstuff. Similarly, all the properties of a solution depend on the nature of the solute and solvent and also on the proportion of the solute in the solution. The proportion of a solute in a solution is called the concentration of the solute in the solution. When the concentration of a solute in its solution is high, it is a concentrated solution, while the solution is called a dilute solution when the concentration of the solute is low.

Several units are used to express the concentration of a solution. Two of these units are used more frequently. The first unit is the mass of solute in grams dissolved in one litre of the solution. (grams per litre, g/L). The second unit is the number of moles of the solute dissolved in one litre of the solution. This is also called the molarity (M) of the solution. The molarity of a solute is indicated by writing its molecular formula inside a square bracket. For example '[NaCl] = 1' means the molarity of this solution of common salt is 1M (1 Molar).

Complete the following table of the concentration of various aqueous solutions.

Solute			Quantity of solute		Volume of solution	Concentration of the solution	
A	B	C	D	$E = \frac{D}{C}$	F	$G = \frac{D}{F}$	$H = \frac{E}{F}$
Name	Molecular formula	Molecular mass (u)	Gram (g)	Mole (mol)	Litre (L)	Gram/litre (g/L)	Molarity (M) mole/litre (mol/L)
Sodium Chloride	NaCl	58.5 u	117 g	2 mol	2 L	58.5 g/L	1 M
.....	HCl	3.65 g	1 L
.....	NaOH	1.5 mol	2 L

pH of solution

We have seen that acids and bases dissociate to a smaller or larger extent on dissolving in water forming H^+ and OH^- ions respectively. H^+ and OH^- ions are found in different proportions in all natural aqueous solutions, and that determines the properties of those solutions.

For example, the proportion of H^+ and OH^- ions divides soil into the acidic, neutral and basic types. It is necessary for blood, cell sap, etc. to have H^+ and OH^- ions in certain definite proportions for their proper functioning. Fermentation and other biochemical processes carried out with the help of micro-organisms, and also many chemical processes require the proportion of H^+ and OH^- ions to be maintained within certain limits. Pure water also undergoes dissociation to a very small extent and gives rise to H^+ and OH^- ions in equal proportion.

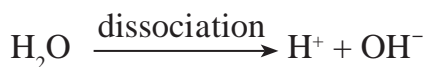

Due to this property of water to undergo dissociation, there exist both H^+ and OH^- ions in any aqueous solution. However, their concentration may be different.

pH of some common aqueous solutions

	Solution	pH	
Strong acids	1M HCl	0.0	
	Gastric juice	1.0	
	Lemon juice	2.5	
	Vinegar	3.0	
	Tomato juice	4.1	
	Black coffee	5.0	
	Acid rain	5.6	
	Weak acids	Urine	6.0
		Neutral	6.5
		weak bases	7.0
Strong bases	Pure water, sugar solution	7.0	
	Blood	7.4	
	Solution of baking soda	8.5	
	Toothpaste	9.5	
	Milk of magnesia	10.5	
	Limewater	11.0	
	1 M NaOH	14.0	

The concentration of H^+ ions formed by dissociation of water is 1×10^{-7} mol/L at 25°C . At the same temperature, the concentration of H^+ ions in 1M solution of HCl is 1×10^0 mol/L, on the other hand in a 1M NaOH solution, the concentration of H^+ ions is 1×10^{-14} mol/L. Thus, we see that in common aqueous solutions, the range of H^+ ion concentration is very wide from 10^0 to 10^{-14} mol/L. In 1909, the Danish scientist Sorensen introduced a convenient new scale of expressing H^+ ion concentration which is found to be very useful in chemical and biochemical processes. It is the pH scale (pH : power of hydrogen) The pH scale extends from 0 to 14. According to this scale pure water has a pH of 7 which means that pure water has ' $[H^+] = 1 \times 10^{-7}$ mol/L.' pH 7 indicates a neutral solution. This pH is the midpoint of the scale. The pH of an acidic solution is less than 7 and that of a basic solution is greater than 7. The table (See page no. 63) gives the pH values of some common solutions.

By which other method could we find out the pH of a solution?

Universal indicators



Can you recall?

What are the colours of the following natural and synthetic indicators in acidic and basic solutions?

Litmus, turmeric, *jamun*, methyl orange, phenolphthalein?

We know that some natural and synthetic dyes show two different colours in acidic and basic solutions, and such dyes are used as acid-base indicators. In the pH scale, the pH of solutions varies from 0 to 14 in accordance with the strength of the acid or base. To show these variations in pH, a universal indicator is used. A universal indicator shows different colours at different values of pH.

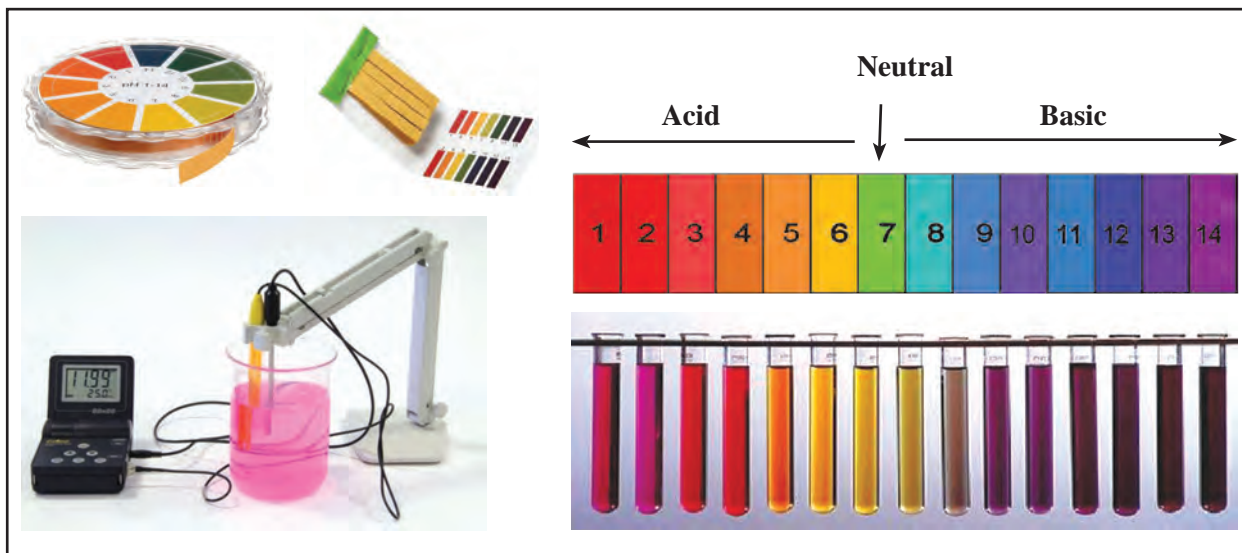

5.4 Measurement of pH : universal indicator and pH meter

A universal indicator is made by mixing several synthetic indicators in specific proportions. The pH of a solution can be determined by means of a universal indicator solution or the pH paper made from it. However, the most accurate method of measuring the pH of a solution is to use an electrical instrument called pH meter. In this method, pH is measured by dipping electrodes into the solution.

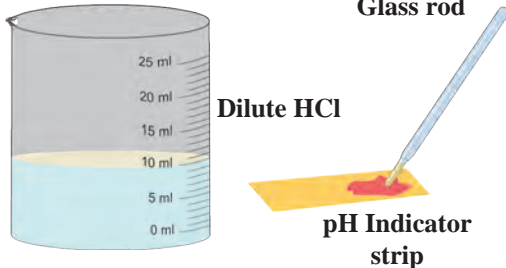

5.5 Neutralization

Reactions of acids and bases

1. Neutralization

Do this : Take 10ml dilute HCl in a beaker. Use a glass rod to put a drop of this solution on a pH paper pH indicator strip and record the pH of the solution. Add to it a few drops of dilute NaOH solution by means of a dropper and stir the solution with the glass rod. Measure the pH of the resulting solution by putting a drop of this solution on another pH paper. In this manner, go on adding dilute NaOH drop by drop and recording the pH. What do you find? Stop adding NaOH when a green colour appears on the pH paper, that is when the pH of the solution becomes 7.

The neutralization reaction : Why does the pH increase as NaOH solution is added drop by drop to the HCl solution? The answer lies in the process of dissociation. Both HCl and NaOH dissociate in their aqueous solutions. Addition of NaOH solution to HCl solution is like adding a large concentration of OH⁻ ions to a large concentration of H⁺ ions. However water dissociates into H⁺ and OH⁻ ions to a very small extent. Therefore, on mixing, the excess OH⁻ ions combine with the excess H⁺ ions to form H₂O molecules which mix with the solvent water. This change can be represented by the ionic equation shown as follows.



It can be seen from the above equation that the Na⁺ and Cl⁻ ions are on both the sides. Therefore the net ionic reaction is

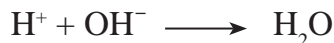

As the NaOH solution is added drop by drop to the HCl solution, the concentration of H⁺ goes on decreasing due to combination with added OH⁻ ions, and that is how the pH goes on increasing.

When enough NaOH is added to HCl, the resulting aqueous solution contains only Na⁺ and Cl⁻ ions, that is, NaCl, a salt, and the solvent water. The only source of H⁺ and OH⁻ ions in this solution is dissociation of water. Therefore, this reaction is called the neutralization reaction. The neutralization reaction is also represented by the following simple equation.

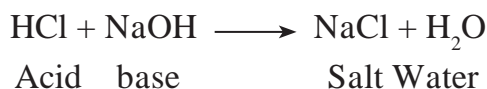

Complete the following table of neutralization reactions and also write down the names of the acids, bases and salts in it.

Acid	+	base	→	Salt	+	Water
HNO ₃	+	→	KNO ₃	+	H ₂ O
.....	+	2 NH ₄ OH	→	(NH ₄) ₂ SO ₄	+
.....	+	KOH	→	KBr	+



Always remember

In the neutralization reaction, an acid reacts with a base to form a salt and water.



Use your brain power !

What would be the definition of an acid and a base with reference to the neutralization reaction?

2. Reaction of acids with metals

The reaction of acids with metals is determined by the strength and the concentration of the acid and also by the reactivity of the metal and the temperature. It is easy to bring about the reaction of a dilute solution of strong acids with moderately reactive metals at normal temperature.



Try this

Activity : Take a big test tube. Choose a rubber stopper in which a gas tube can be fitted. Take a few pieces of magnesium ribbon in the test tube and add some dilute HCl to it. Take a lighted candle near the end of the gas tube and observe. What did you observe?

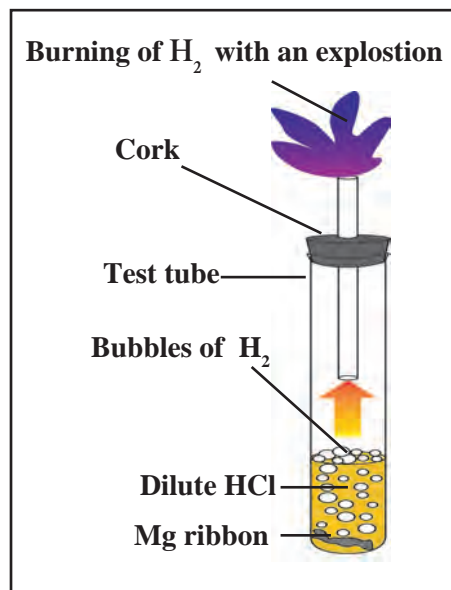

5.6 Reaction of a dilute solution of a strong acid with a metal

Magnesium metal reacts with dilute hydrochloric acid and an inflammable gas, hydrogen, is formed. During this reaction, the reactive metal displaces hydrogen from the acid to release hydrogen gas. At the same time, the metal is converted into basic radical which combines with the acidic radical from the acid to form the salt.

Complete the following reactions.

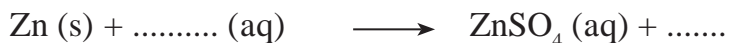
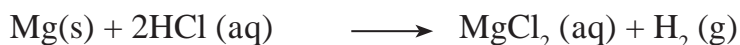
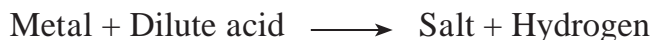

3. Reaction of acids with oxides of metals



Try this



Take some water in a test tube and add a little red oxide (the primer used before painting iron articles) to it. Now add a small quantity of dilute HCl to it, shake the test tube and observe.

1. Does the red oxide dissolve in water?
2. What change takes place in the particles of red oxide on adding dilute HCl ?

The chemical formula of red oxide is Fe_2O_3 . The water-insoluble red oxide reacts with HCl to produce a water soluble salt FeCl_3 . This gives a yellowish colour to the water. The following chemical equation can be written for this chemical change.



Complete the following.

Metal oxide + dilute acid \longrightarrow Salt + Water

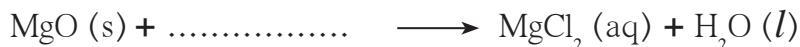

1. What type of compound is a metal oxide, with reference to neutralization reaction?
2. Explain the statement ‘Metal oxides are basic in nature.’

4. Reaction of bases with oxides of non-metals



Try this

Bases react with oxides of non-metals to form a salt and water. Hence, oxides of non-metals are said to be acidic in nature. Sometimes the oxides of non-metals themselves are said to be examples of acids.

Complete the following reactions.

Oxide of non-metal + base \longrightarrow salt + water

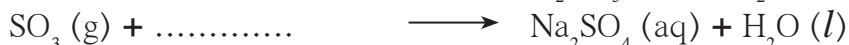
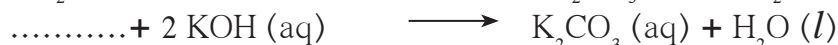

Zinc oxide reacts with sodium hydroxide to form sodium zincate (Na_2ZnO_2) and water. Similarly, aluminium oxide reacts with sodium hydroxide to form sodium aluminate (NaAlO_2) and water.



Use your brain power !

1. Write down chemical equations for both these reactions.
2. Can we call Al_2O_3 and ZnO acidic oxides on the basis of these reactions?
3. Define ‘amphoteric oxides’ and give two examples.

5. Reaction of acids with carbonates and bicarbonates of metals



Try this

Activity : Fit a bent tube in a rubber cork. Take some lime water in a test tube and keep it handy. Take some baking soda in another test tube and add some lemon juice to it. Immediately fit the bent tube over it. Insert its other end into the lime water. Note down your observations of both the test tubes. Repeat the procedure using washing soda, vinegar and dilute HCl properly. What do you see?

In this activity, when limewater comes in contact with the gas released in the form of an effervescence, it turns milky. This is a chemical test for carbon dioxide gas. When lime water turns milky, we infer that the effervescence is of carbon dioxide gas. This gas is produced on reaction of acids with carbonate and bicarbonate salts of metals. A precipitate of CaCO_3 is produced on its reaction with the limewater Ca(OH)_2 . This reaction can be represented by the following chemical equation.

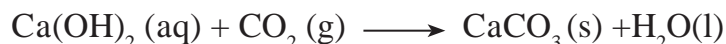

Complete the reactions in the following table.

Carbonate salt of metal + dilute acid \longrightarrow Another salt of metal + Carbon dioxide	
$\text{Na}_2\text{CO}_3 (\text{s}) + 2 \text{HCl} (\text{aq})$	$\longrightarrow 2 \text{NaCl} (\text{aq}) + \text{CO}_2 (\text{g}) + \text{H}_2\text{O} (\text{l})$
$\text{Na}_2\text{CO}_3 (\text{s}) + \dots\dots\dots$	$\longrightarrow \text{Na}_2\text{SO}_4 (\text{aq}) + \text{CO}_2 (\text{g}) + \dots\dots\dots$
$\text{CaCO}_3 (\text{s}) + 2 \text{HNO}_3 (\text{aq})$	$\longrightarrow \dots\dots\dots + \dots\dots\dots + \dots\dots\dots$
$\text{K}_2\text{CO}_3 (\text{s}) + \text{H}_2\text{SO}_4 (\text{aq})$	$\longrightarrow \dots\dots\dots + \dots\dots\dots + \dots\dots\dots$
Bicarbonate salt of metal + dilute acid \longrightarrow Another salt of metal + carbon dioxide + water	
1. $\text{NaHCO}_3 (\text{s}) + \text{HCl} (\text{aq})$	$\longrightarrow \text{NaCl} (\text{aq}) + \text{CO}_2 (\text{g}) + \text{H}_2\text{O} (\text{l})$
2. $\text{KHCO}_3 (\text{s}) + \text{HNO}_3 (\text{aq})$	$\longrightarrow \dots\dots\dots + \dots\dots\dots + \dots\dots\dots$
3. $\text{NaHCO}_3 (\text{s}) + \dots\dots\dots$	$\longrightarrow \text{CH}_3\text{COONa} (\text{aq}) + \dots\dots\dots + \dots\dots\dots$

Salts

Types of salts : acidic, basic and neutral salts



Try this

Activity : Prepare 10 ml aqueous solutions from 1gm each of sodium chloride, ammonium chloride and sodium bicarbonate. Measure pH of each solution by means of pH paper. Are the values the same for all three? Classify the salts based on the pH values.

We have seen that salts are formed by the reaction between acids and bases. Though this reaction is called a neutralization reaction, the resulting salts are not always neutral. A neutral salt is formed by neutralization of a strong acid by a strong base. The aqueous solution of a neutral salt has pH equal to 7.

An acidic salt is formed by the neutralization reaction between a strong acid and a weak base. The pH of the aqueous solution of an acidic salt is less than 7. On the contrary, a basic salt is formed by a neutralization reaction between a weak acid and a strong base. The pH of an aqueous solution of such a basic salt is greater than 7.

Classify the following salts into the types acidic, basic and neutral. Sodium sulphate, potassium chloride, ammonium nitrate, sodium carbonate, sodium acetate, sodium chloride.

Water of crystallisation



Try this

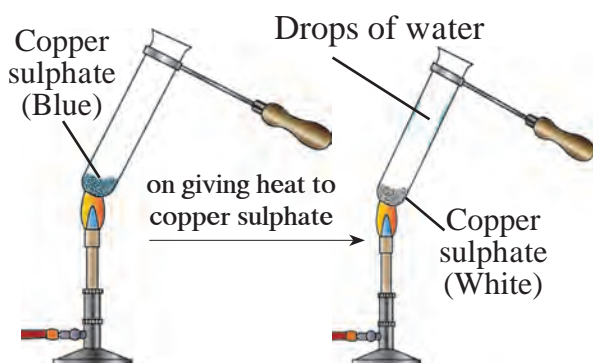

5.7 Properties of water of crystallisation

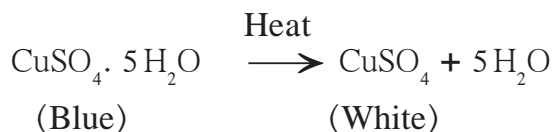

It is called water of crystallisation. On adding water to the white powder a solution was formed which had the same colour as the solution in the first test tube. From this we come to know that no chemical change has occurred in the crystals of blue vitriol due to heating. Losing water on heating blue vitriol, breaking down of the crystal structure, losing blue colour and regaining blue colour on adding water are all physical changes.

Repeat the above activity for Ferrous sulphate, sodium carbonate and write chemical equations. Take 'x' as a coefficient for H₂O.



Try this

Apparatus : Evaporating dish, Bunsen burner, tripod stand, wire gauze, etc.

Chemicals : Alum.

Procedure : Take a small stone of alum in the evaporating dish. Keep the dish on the tripod stand and heat it with the help of burner.

What did you see in the dish? What is meant by puffed alum?

Ionic compounds are crystalline in nature. These crystals are formed as a result of definite arrangement of ions. In the crystals of some compounds water molecules are also included in this arrangement. That is the water of crystallisation. The water of crystallisation is present in a definite proportion of the chemical formula of the compound. It is indicated in the chemical formula as shown below.

1. Crystalline blue vitriol- $\text{CuSO}_4 \cdot 5\text{H}_2\text{O}$
2. Crystalline ferrous sulphate
(Green vitriol) - $\text{FeSO}_4 \cdot 7\text{H}_2\text{O}$
3. Crystalline washing soda - $\text{Na}_2\text{CO}_3 \cdot 10\text{H}_2\text{O}$
4. Crystalline alum - $\text{K}_2\text{SO}_4 \cdot \text{Al}_2(\text{SO}_4)_3 \cdot 24\text{H}_2\text{O}$

1. Crystalline substances contain water of crystallisation.
2. The molecules of water of crystallisation are part of the internal arrangement of the crystal.
3. On heating or just by keeping, the water of crystallisation is lost and the crystalline shape of that part is lost.

Ionic compounds and electrical conductivity



Try this

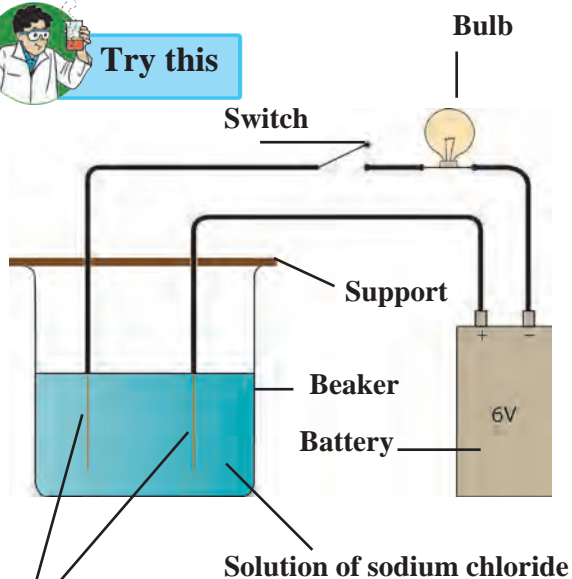

Bare electric wire

5.8 Testing the electrical conductivity of a solution



Use your brain power !

1. With which solutions did the bulb glow?
2. Which solutions are electrical conductors?

The bulb glows only when electric current passes through it. And this can happen only when the electric circuit is complete. In the above activity, the circuit is found to be complete when the aqueous solutions of NaCl, CuSO₄, H₂SO₄ and NaOH are used. It means that these solutions are conductors of electricity.

Electrons conduct electricity through electrical wires; and ions conduct electricity through a liquid or a solution. Electrons leave the battery at the negative terminal, complete the electric circuit and enter the battery at the positive terminal. When there is a liquid or a solution in the circuit, two rods, wires or plates are immersed in it. These are called electrodes. Electrodes are usually made of a conducting solid. The electrode connected to the negative terminal of a battery by means of a conducting wire is called a **cathode** and the electrode connected to the positive terminal of a battery is called an **anode**.

Why does the electric circuit get completed on immersing the electrodes in certain liquids or solutions? In order to understand this phenomenon, let us look more closely at the solutions in the above activity, which were found to be electrical conductors.

Dissociation of ions and electrical conductivity

In the above activity it was found that the aqueous solutions of the compounds NaCl, CuSO₄, H₂SO₄ and NaOH are electricity conductors. Out of these NaCl and CuSO₄ are salts, H₂SO₄ is a strong acid and NaOH is a strong base. We have seen that salts, strong acids and strong bases dissociate almost completely in their aqueous solutions. Therefore, the aqueous solutions of all these three contain large numbers of cations and anions.

Activity : Prepare a solution of 1g sodium chloride in 50ml water. Take two electrical wires. Connect one wire to the positive terminal of a 6V battery. While connecting the other wire to the negative terminal of the battery, include one switch and one holder with an electric bulb. Remove the insulating cladding from 3cm portion of the other free ends of the two wires. Take the salt solution in a 100ml capacity beaker and immerse the uncovered ends of the two wires in it keeping the wire erect with the help of a support. Switch on the current. Note whether the bulb glows. Repeat the same procedure using solutions of 1g copper sulphate, 1g glucose, 1g urea, 5ml dilute H₂SO₄ and 5ml dilute NaOH each in 50ml water. Record your observations in a table. **(Do not forget to clean the beaker and uncovered part of the wires with water, every time you change the solution.)**

A characteristic of the liquid state is the mobility of its particles. Due to this mobility, the positively charged cations in the solution are attracted towards the negative electrode or cathode and move towards the cathode; on the other hand, the negatively charged anions move in the direction of the anode. The movement of ions in the solution towards the respective electrodes amounts to the conduction of electricity through the solution. From this, you will understand that those liquids or solutions which contain a large number of dissociated ions conduct electricity.

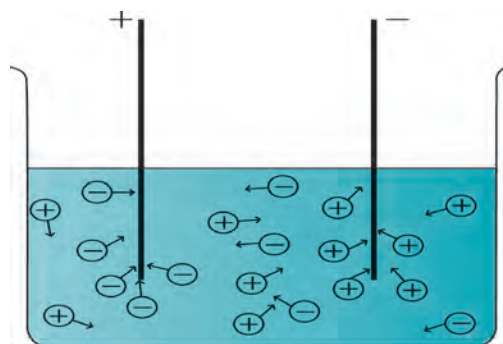

5.9 Dissociation of ions



Try this

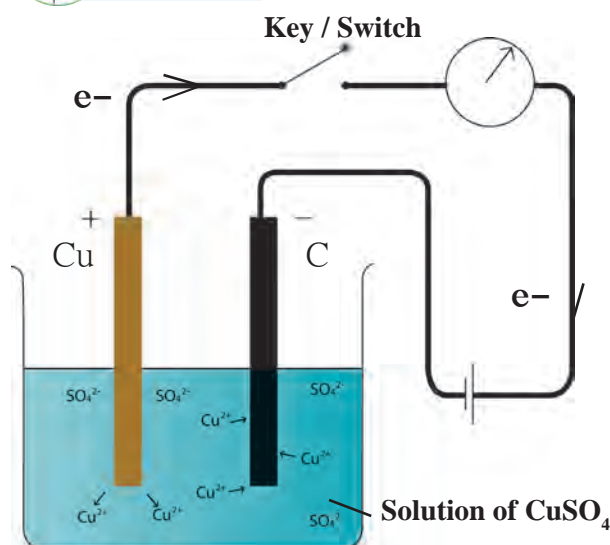

5.10 Electrolysis

Electrolysis

Procedure : Take a solution of 1g copper sulphate in 50ml water in a 100ml capacity beaker. Use a thick plate of copper as anode and a carbon rod as cathode. Arrange the apparatus as shown in the figure and pass an electric current through the circuit for some time. Do you see any changes?

In the above activity copper appears to have deposited on the portion of the cathode immersed in the solution. How did this happen? When an electric current started flowing through the circuit, the cations, that is, Cu^{++} ions in the solution got attracted towards the cathode. Cu atoms are formed when electrons coming out from the cathode combine with the Cu^{++} ions. A deposit of the copper appeared on the cathode. Even though

the Cu^{++} ions in the solution were used up in this manner, the colour of the solution remained the same. Because, while electric current was on, electrons were removed from the Cu atoms of the anode and sent to the battery through the electric wire. The Cu^{++} ions formed in this manner, entered the solution. In this way decomposition of the solute in the solution took place due to the electric current. This is called electrolysis. There are two parts in the electrolysis process. These are the cathode reaction and the anode reaction. The two parts of the electrolysis process that take place in the above activity are shown below.

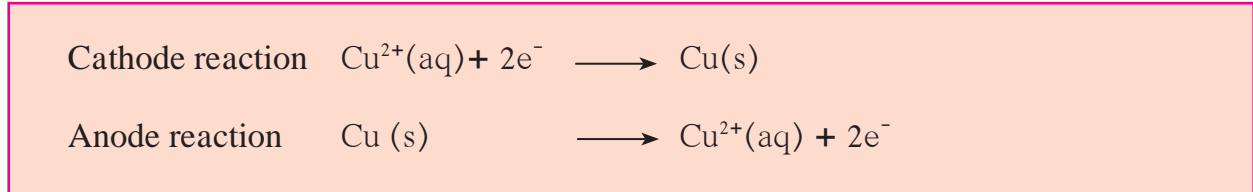



Always remember

1. It is necessary for the liquid/solution to have a large number of dissociated ions for electrolysis to take place. Therefore, substances which undergo dissociation to great extent in the liquid state or a solution are called strong **electrolytes**. Salts, strong acids and strong bases are strong electrolytes. Their solutions have high electrical conductivity. In other words strong electrolytes are good conductors of electricity in their liquid or solution state. Weak acids and weak bases are weak electrolytes.
2. An assembly that consists of a container electrolyte and the electrodes dipped in it, is called an electrolytic cell.



Use your brain power !

1. In the above activity, if electric current passed through the electrolytic cell for a long time, what change would be seen at the anode?
2. Would water be a good conductor of electricity?

Website for more information

www.chemicalformula.org

If pure water is used in an electrolytic cell, current does not flow even on putting on the switch. From this we learn that pure water is a bad conductor of electricity. And we have already seen the reason behind this. The concentration of H^+ and OH^- ions formed by dissociation of water is very low, only 1×10^{-7} mol/L for each ion. However, the electrical conductivity of water increases on mixing a small amount of salt or a strong acid/base in it due to their dissociation and electrolysis of water takes place.

Electrolysis of water



Try this

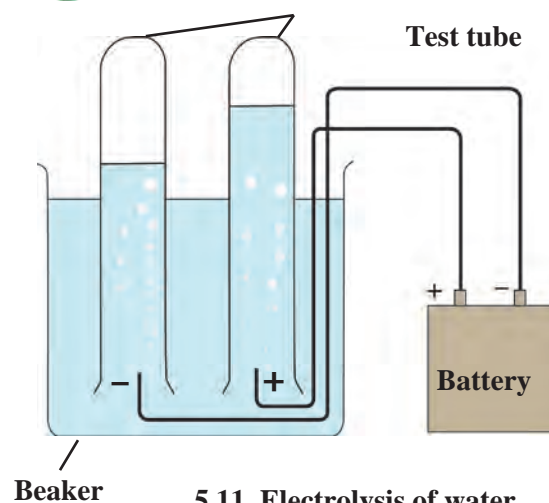

Activity : Dissolve 2g salt in 500ml pure water. Take 250 ml of this solution in a 500ml capacity beaker. Connect two electrical wires to the positive and negative terminals of a power supply. Remove the insulating cladding from about 2cm portions at the other ends of the wires. These are the two electrodes. Fill two test tubes upto the brim with the prepared dilute salt solution. Invert them on the electrodes without allowing any air to enter. Start the electric current under 6V potential difference from the power supply. Observe what happens in the test tubes after some time.

5.11 Electrolysis of water

1. Did you see the gas bubbles forming near the electrodes in the test tubes?
2. Are these gases heavier or lighter than water?
3. Are the volumes of the gases collected over the solution in the two test tubes the same or different?

It is found in the above activity that the volume of the gas formed near the cathode is double that of the gas formed near the anode. Scientists have shown that hydrogen gas is formed near the cathode and oxygen gas near the anode. From this, it is clear that electrolysis of water has taken place and its constituent elements have been released. The concerned electrode reactions are as follows.

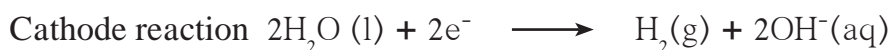

1. Test the solutions in the two test tubes with litmus paper, what do you see ?
2. Repeat the activity by using dilute H_2SO_4 as well as dilute NaOH as the electrolyte.



Research

There are many applications of electrolysis of electrolytes. Collect information about them.

Exercises

1. Identify the odd one out and justify.

- (a) Chloride, nitrate, hydride, ammonium
- (b) Hydrogen chloride, sodium hydroxide, calcium oxide, ammonia
- (c) Acetic acid, carbonic acid, hydrochloric acid, nitric acid
- (d) Ammonium chloride, sodium chloride, potassium nitrate, sodium sulphate
- (e) Sodium nitrate, sodium carbonate, sodium sulphate, sodium chloride
- (f) Calcium oxide, magnesium oxide, zinc oxide, sodium oxide.
- (g) Crystalline blue vitriol, crystalline common salt, crystalline ferrous sulphate, crystalline sodium carbonate.
- (h) Sodium chloride, potassium hydroxide, acetic acid, sodium acetate.

2. Write down the changes that will be seen in each instance and explain the reason behind it.

- (a) 50ml water is added to 50ml solution of copper sulphate.
- (b) Two drops of the indicator phenolphthalein were added to

10ml solution of sodium hydroxide.

- (c) Two or three filings of copper were added to 10ml dilute nitric acid and stirred.
- (d) A litmus paper was dropped into 2ml dilute HCl . Then 2ml concentrated NaOH was added to it and stirred.
- (e) Magnesium oxide was added to dilute HCl and magnesium oxide was added to dilute NaOH .
- (f) Zinc oxide was added to dilute HCl and zinc oxide was added to dilute NaOH .
- (g) Dilute HCl was added to limestone.
- (h) Pieces of blue vitriol were heated in a test tube. On cooling, water was added to it.
- (i) Dilute H_2SO_4 was taken in an electrolytic cell and electric current was passed through it.

3. Classify the following oxides into three types and name the types.

CaO , MgO , CO_2 , SO_3 , Na_2O , ZnO , Al_2O_3 , Fe_2O_3

4. Explain by drawing a figure of the electronic configuration.

- a. Formation of sodium chloride from

sodium and chlorine.

b. Formation of magnesium chloride from magnesium and chlorine.

5. **Show the dissociation of the following compounds on dissolving in water, with the help of chemical equation and write whether the proportion of dissociation is small or large.**

Hydrochloric acid, Sodium chloride, Potassium hydroxide, Ammonia, Acetic acid, Magnesium chloride, Copper sulphate.

6. **Write down the concentration of each of the following solutions in g/L and mol/L.**

- 7.3g HCl in 100ml solution
- 2g NaOH in 50ml solution
- 3g CH_3COOH in 100ml solution
- 4.9g H_2SO_4 in 200ml solution

7. **Answer the following questions.**

- Classify the acids according to their basicity and give one example of each type.
- What is meant by neutralization? Give two examples from everyday life of the neutralization reaction.
- Explain what is meant by electrolysis of water. Write the electrode reactions and explain them.

8. **Write the chemical equations for the following activities.**

- NaOH solution was added to HCl solution.
- Zinc dust was added to dilute H_2SO_4 .
- Dilute nitric acid was added to calcium oxide.
- Carbon dioxide gas was passed through KOH solution.
- Dilute HCl was poured on baking soda.

9. **State the differences.**

- Acids and bases
- Cation and anion
- Negative electrode and positive electrode.

10. **Classify aqueous solutions of the following substances according to their pH into three groups : 7, more than 7, less than 7.**

Common salt, sodium acetate, hydrochloric acid, carbon dioxide, potassium bromide, calcium hydroxide, ammonium chloride, vinegar, sodium carbonate, ammonia, sulphur dioxide.

Project :

- Collect information about electroplating. Make a list of articles in day-to-day life, where this technique is used.
- Obtain a sample of rainwater. Add to it a few drops of universal indicator. Measure its pH. Describe the nature of the sample of rainwater and write the effect it has on the living world.



6. Classification of plants



- Kingdom Plantae
- Sub-kingdom: Gymnosperms
- Sub-kingdom: Angiosperms



Can you recall?

How have living organisms been classified?

You have already studied the kingdoms Monera, Protista and Fungi of the 'Five Kingdom' classification system proposed by Robert Whittaker (1969) for the study of living organisms.

What are the hidden secrets of the Kingdom plantae which impart this green freshness to our surroundings? Just how much diversity is there in this Kingdom? Let us see!

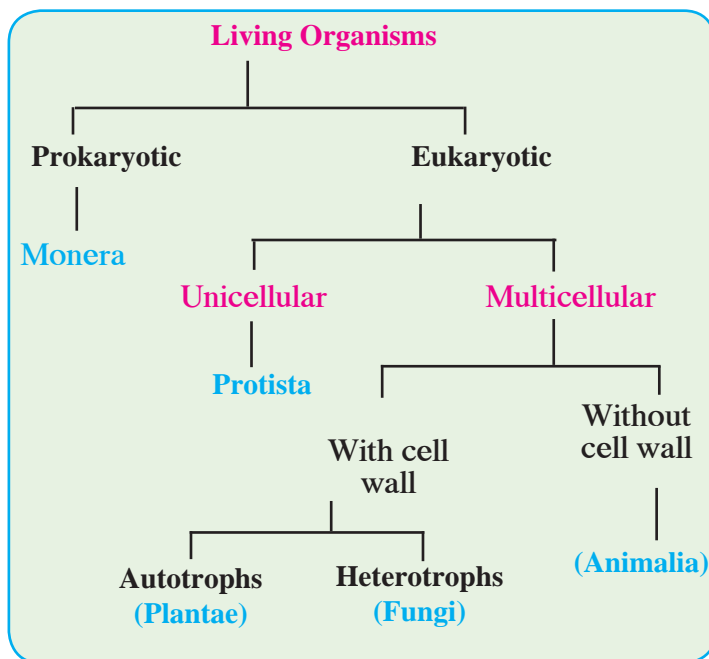

Kingdom plantae



Can you tell?

Which are the special cell organelles that differentiate plant cells from animal cells?

The group of autotrophic living organisms having eukaryotic cells with cell walls is the group of plants. Plants have become autotrophic as they can perform photosynthesis with the help of chlorophyll. Living organisms of kingdom plantae are the main source of food for all other living organisms.

Basis for classification :

The presence or absence of organs is the first criterion for classification of plants. The presence or absence of separate conducting tissues for conduction of water and food is the next consideration for classification. Do the plants bear seeds? If they do then, whether the seeds are enclosed in a fruit or not is also an important criterion for classification. Finally, plants are grouped depending upon the number of cotyledons in the seeds.

At the higher levels of plant classification, different characteristics are considered for classification, e.g. depending upon the absence or presence of flowers, fruits and seeds, plants are classified as cryptogams or phanerogams. Depending upon whether seeds are enclosed within a fruit or not, phanerogams are classified as gymnosperms and angiosperms. Angiosperms are further classified as monocots or dicots depending upon the number of cotyledons in seeds.

An introduction to scientists

In 1883, Eichler, a botanist, classified the Kingdom Plantae into two subkingdoms. As a result, two subkingdoms, cryptogams and phanerogams were considered for plant classification.

Cryptogams



Observe

Search for a pond with greenish water. Collect some of the green fibres from the water. Put the fibres in a Petri dish and wash them clean with water. Put one of the fibres in a drop of water on a glass slide and spread it out straight.

Put a cover-slip over the slide and observe under a compound microscope. Do you see the spirally arranged green thread-like chloroplasts in the cells in that straight fibre? This plant is known as *Spirogyra*.

Division I - Thallophyta

These plants grow mainly in water. This group of plants, which do not have specific parts like root-stem-leaves-flowers but are autotrophic due to the presence of chlorophyll, is called algae. Algae show great diversity. They may be unicellular or multicellular, and microscopic or large. Examples of algae are *Spirogyra*, *Ulothrix*, *Ulva*, *Sargassum*, etc. Some of these are found in fresh water while some are found in saline water. These plants usually have a soft and fibre-like body. Various types of **fungi** like yeasts and moulds which do not have chlorophyll are also included in this group.

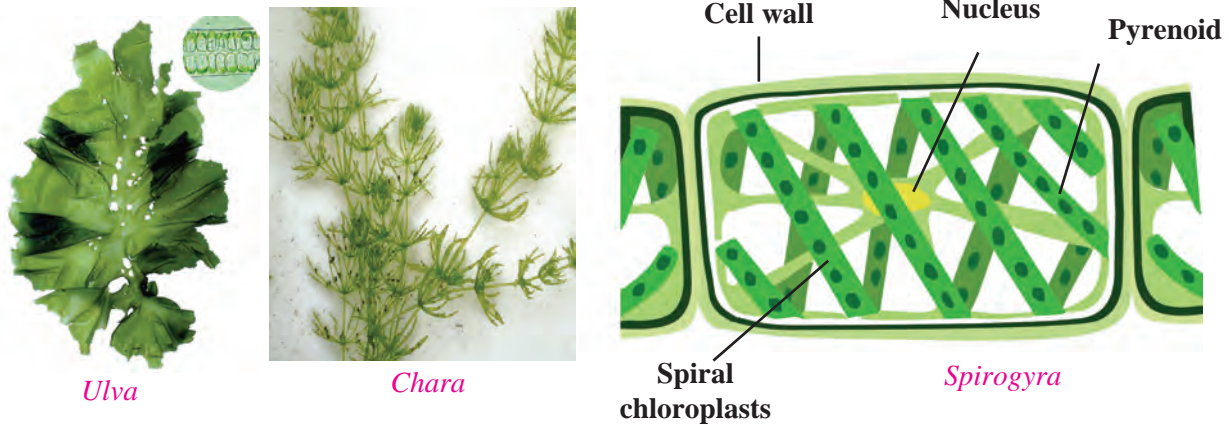

6.1 Plants of the Thallophyta division.

Division II - Bryophyta



Observe and discuss.

You may have seen a lush green soft carpet on old walls, bricks and rocks in the rainy season. Scrape it gently with a small ruler, observe it under a magnifying lens and discuss.

This group of plants is called the ‘amphibians’ of the plant kingdom because they grow in moist soil but need water for reproduction. These plants are thalloid, multicellular and autotrophic. They reproduce by spore formation. The structure of the plant body of bryophytes is flat, ribbon-like long, without true roots, stem and leaves. Instead, they have stem-like or leaf-like parts and root-like rhizoids. They do not have specific tissues for conduction of food and water. Examples are Moss (*Funaria*), *Marchantia*, *Anthoceros*, *Riccia*, etc.

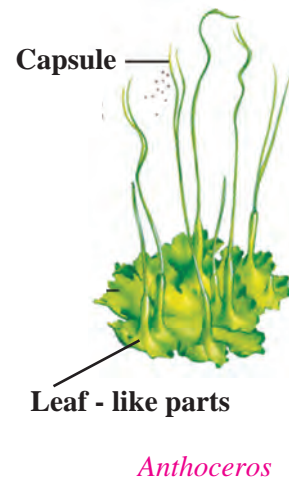
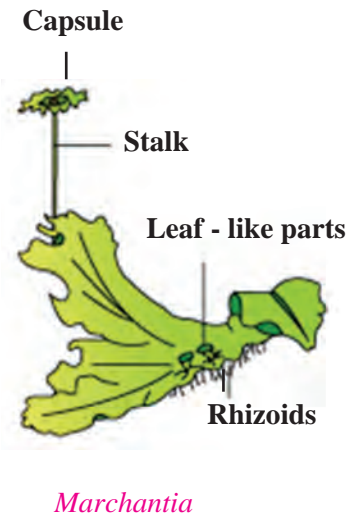
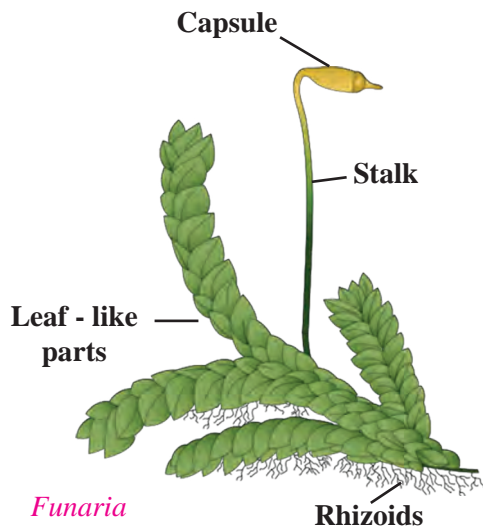

6.2 Plants of the bryophyta division



Observe and discuss.

You may have seen ferns among the ornamental plants in a garden. Take a leaf of a fully grown fern and observe it carefully.

Division III- Pteridophyta

Plants from this group have well-developed roots, stem and leaves and separate tissues for conduction of food and water. But, they do not bear flowers and fruits. They reproduce with the help of spores formed along the back or posterior surface of their leaves. Examples are ferns like *Nephrolepis*, *Marsilea*, *Pteris*, *Adiantum*, *Equisetum*, *Selaginella*, *Lycopodium*, etc.

These plants reproduce asexually by spore-formation and sexually by zygote formation. They have a well-developed conducting system.



Use your brain power !

What is the similarity between the plants of the groups Thallophyta, Bryophyta and Pteridophyta irrespective of differences in their body structure?



Sporangia in sori on leaflet

Selaginella



Lycopodium

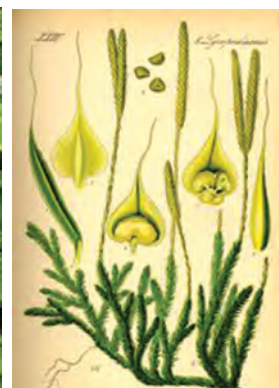

6.3 Plants of the pteridophyta division

All these plants reproduce by spore formation. They are called cryptogams as their reproductive organs cannot be seen. (cryptos: hidden, gams: reproductive organs).

Phanerogams

Plants which have special structures for reproduction and produce seeds are called phanerogams. In these plants, after the process of reproduction, seeds are formed which contain the embryo and stored food. During germination of the seed, the stored food is used for the initial growth of the embryo. Depending upon whether seeds are enclosed in a fruit or not, phanerogams are classified into gymnosperms and angiosperms.

Division I - (Gymnosperms)



Observe

Observe all garden plants like *Cycas*, Christmas tree, *Hibiscus*, lily, etc. and compare them. Note the similarities and differences among them. Which differences did you notice between gymnosperms and angiosperms?

Gymnosperms are mostly evergreen, perennial and woody. Their stems are without branches. The leaves form a crown. These plants bear male and female flowers on different sporophylls of the same plant. Seeds of these plants do not have natural coverings, i.e. these plants do not form fruits and are therefore called gymnosperms. (gymnos: naked, sperms: seeds).

Examples *Cycas*, *Picea* (Christmas tree), *Thuja* (Morpankhi), *Pinus* (Deodar), etc.

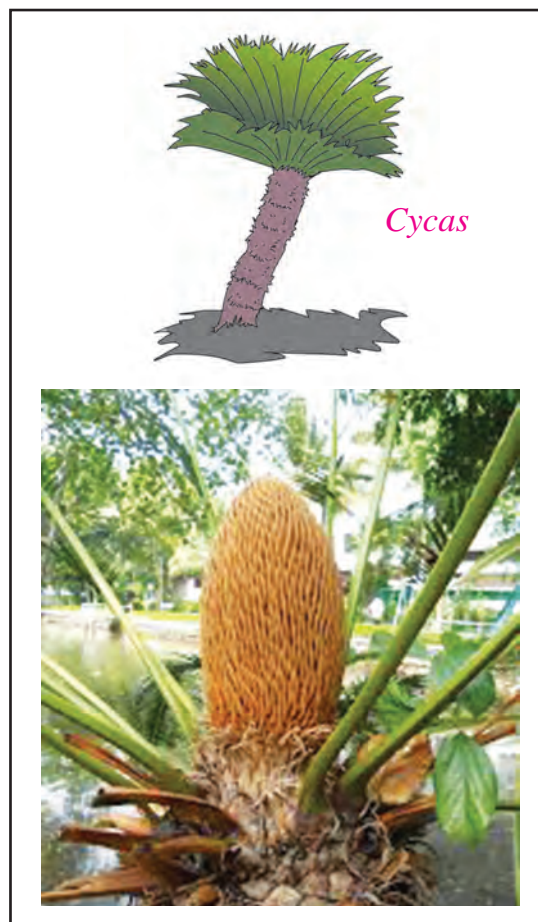

6.4 Gymnosperms

Division II- Angiosperms



Try this

Soak the seeds of corn, beans, groundnut, tamarind, mango, wheat, etc. in water for 8 to 10 hrs. After they are soaked, check each seed to see whether it divides into two equal halves or not and categorize them accordingly.

The flowers these plants bear are their reproductive organs. Flowers develop into fruits and seeds are formed within fruits. Thus, these seeds are covered; hence, they are called angiosperms (angios: cover, sperms: seeds).

The plants whose seeds can be divided into two equal halves or dicotyledons are called dicotyledonous plants and those whose seeds cannot be divided into equal parts are called monocotyledonous plants.



Observe and verify

	Dicotyledonous plants	Monocotyledonous
Seed	Two cotyledons	Single cotyledon
Root	Well developed, primary root (Tap root)	Fibrous roots
Stem	Strong, hard. Ex. Banyan tree	Hollow, Ex. Bamboo False, Ex. Banana Disc-like, Ex. Onion.
Leaf	Reticulate venation	Parallel venation
Flower	Flowers with 4 or 5 parts or in their multiples (tetramerous or pentamerous)	Flowers with 3 parts or in multiples of three (trimerous).



6.4 Mustard and Maize

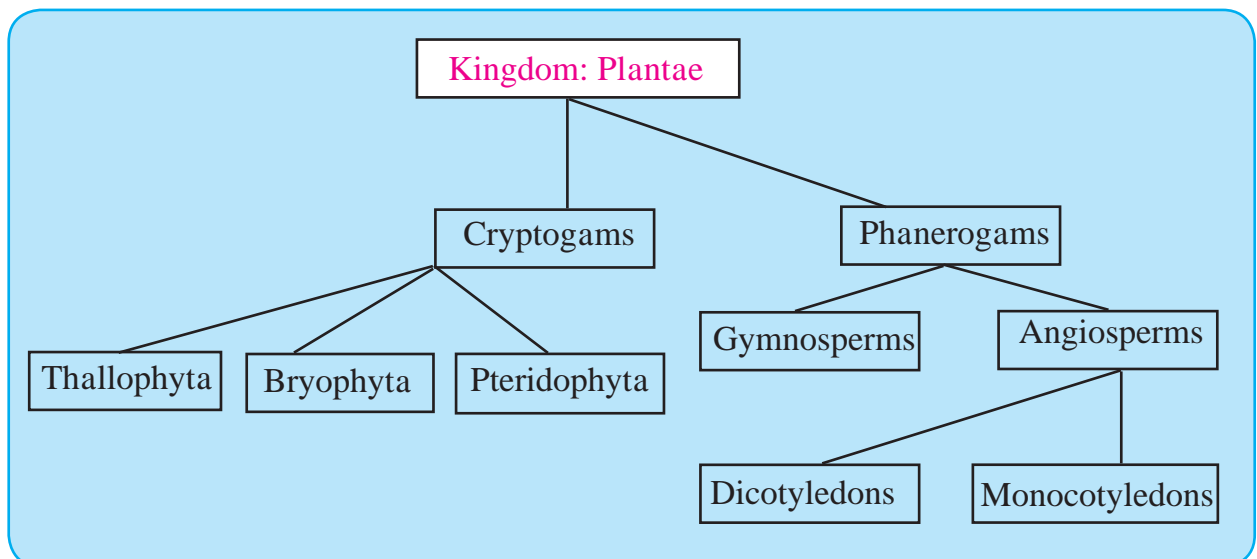

Using ICT:

1. Sketch the diagrams of the plants mentioned in the lesson with the help of the drawing software in the computer.
2. Using those sketches, prepare a power point presentation about plant classification and present it in the class.

Exercises



1. Match the proper terms from columns A and C with the description in column B.

'A'	'B'	'C'
Thallophyta	Seeds are formed in fruits.	Fern
Bryophyta	No natural covering on seeds.	Cycas
Pteridophyta	These plants mainly grow in water.	Tamarind
Gymnosperms	These plants need water for reproduction.	Moss
Angiosperms	Tissues are present for conduction of water and food	Algae

2. Complete the sentences by filling in the blanks and explain those statements.

(angiosperms, gymnosperms, spore, bryophyta, thallophyta, zygote)

- a. plants have soft and fibre-like body.
- b. is called the 'amphibian' of the plant kingdom.
- c. In pteridophytes, asexual reproduction occurs by formation and sexual reproduction occurs byformation.
- d. Male and female flowers ofare borne on different sporophylls of the same plant.

3. Answer the following questions in your own words.

- a. Write the characteristics of subkingdom Phanerogams.
- b. Distinguish between monocots and dicots.
- c. Write a paragraph in your own words about the ornamental plants called ferns.
- d. Sketch, label and describe the *Spirogyra*.

e. Write the characteristics of the plants belonging to division Bryophyta.

4. Sketch and label the figures of the following plants and explain them into brief.

Marchantia, Funaria, Fern, Spirogyra.

5. Collect a monocot and dicot plant available in your area. Observe the plants carefully and describe them in scientific language.

6. Which criteria are used for the classification of plants? Explain with reasons.

Project :

- a. Collect more information about plant classification from the internet, prepare a talk of about 5 to 7 minutes on that topic and present it in school during assembly.
- b. Prepare an album of monocot and dicot seeds and display it in the classroom.
- c. Collect photographs of 5 plants each of the Thallophyta, Bryophyta and Pteridophyta divisions and write a description of each.



7. Energy Flow in an Ecosystem



- Food chain and food web
- The energy pyramid
- Bio-geo-chemical cycle : Carbon, oxygen and nitrogen cycles



Looking back

1. What is meant by 'ecosystem'?
2. Which are the different types of ecosystems?
3. How do interactions take place between biotic and abiotic factors of an ecosystem?

Energy flow in an ecosystem

We have already learnt the classification of living organisms according to the mode of nutrition into producers, consumers, saprotrophs (saprophytes) and decomposers. Consider the various trophic levels of the ecosystem around you as given below.

Primary consumers (herbivores)

Ex. Grasshopper, squirrel, elephant, etc. They are directly dependent on autotrophs (producers).

Secondary consumers (carnivores)

Ex. Frog, owl, fox, etc. These consumers use herbivores as their food.

Apex or top consumers (carnivores)

Ex. Tiger, lion, etc. These consumers use herbivores and carnivores as their food. No other animals feed on top consumers.

Omnivores (mixed consumers)

Ex. Humans, bear, etc. Feed on herbivores, carnivores and producers.

Food chain and food web



Observe

Observe figure 7.1 and explain the relationship between the components.

Construct four chains like the one shown in figure 7.1.

Interactions go on continuously between producers, consumers and saprophytes. There is a definite sequence in these interactions which is called the food chain. Each chain consists of four, five or more links. An ecosystem consists of many food chains that are interconnected at various levels. Thus a food web is formed.

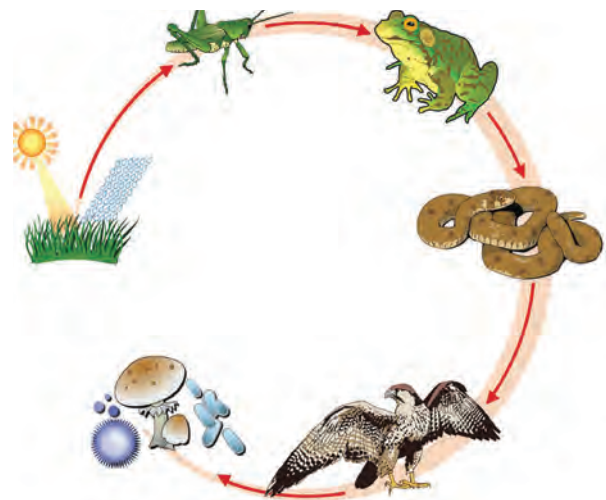

7.1 Food chain



Use your brain power !

Explain the food chains of various ecosystems which you have studied last year.

An organism may be the prey for many other organisms. For example, an insect feeds upon leaves of various plants but the same insect is the prey for different animals like frog, wall lizard, birds, etc. If this is to be shown in a figure, it will form an intricate web instead of a linear food chain. Such an intricate network is called a 'Food Web'. Generally, food-webs are found everywhere in nature.



Use your brain power !

Make a list of the various consumers of the ecosystems around you and classify them according to mode of nutrition.

Pictures of various organisms are given in fig. 7.2. Construct a foodweb from those pictures.

1. Is the number of consumers in a food web fixed?
2. What will be the effect on an ecosystem if only one type of organism in it forms the food for several different consumers in that ecosystem?
3. Why is balance or equilibrium necessary in a foodweb?



7.2 Various living organisms



Research

Make some interesting observations while having a meal at home. Identify the trophic level of the various food items in your dish. Identify your own level in the chain.

The energy pyramid

Trophic level

Each level in the food chain is called a trophic level. A trophic level is the step at which the organism obtains its food in the chain. The amount of matter and energy gradually decreases from producers at lowest level to top consumers at the highest level.

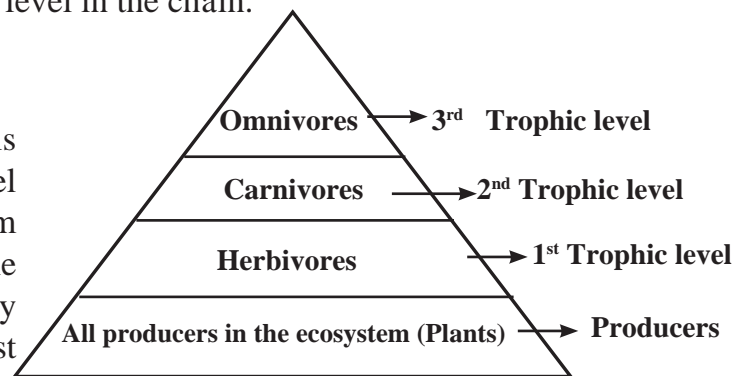

7.3 Trophic levels

An introduction to scientists

Lindeman, In 1942 studied the food chain and energy flow through it. Charles Elton, a British scientist first proposed the concept of the Ecological Pyramid in 1927 after his study of the Tundra Ecosystem of the Beer islands in England. Hence, this pyramid is also called the Eltonian Pyramid.



Think about it

What happens to the energy during its transfer from producers to apex consumers? Does it remain trapped in the apex consumer? Does it remain in the body of apex consumer till its death?



Use your brain power !

What would happen if the energy remains trapped in the body of apex consumers even after their death? What will happen if there were no decomposers like microbes and fungi in nature?

Figure 7.4 shows the energy transfer that takes place at each trophic level. There are different levels of energy exchange in the food chain. The initial quantity of energy goes on decreasing at every level of energy exchange. Similarly, the number of organisms also decreases from the lowest level to the highest level. This pattern of energy exchange in an ecosystem is called a **'Pyramid of energy'**.

After the death of apex consumers, their energy becomes available to the decomposers. Fungi and other micro-organisms decompose the bodies of dead animals. They are called decomposers. In the process of obtaining food from the remains of organisms, decomposers convert them into simple carbon compounds. These substances easily mix with air, water and soil from where they are again absorbed by plants and incorporated into the food chain.

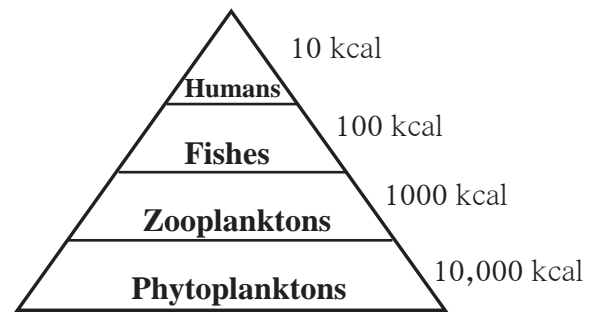

7.4 Pyramid of energy in an aquatic ecosystem

You can now see that due to the food web formed by the various modes of nutrition, energy and various nutrients circulate continuously in the ecosystem.

The sun is the most important source of energy in any ecosystem. Green plants of the ecosystem store some of the solar energy in the form of food. Before reaching the decomposers, this energy is passed on from one trophic level to the next. Decomposers dissipate some amount of energy in the form of heat. However, no part of the energy ever returns to the sun. Hence, such passage of energy is referred to as 'one way' transport.



Use your brain power !

Why are the numbers of tertiary consumers (apex carnivores) always less than those of other consumers?

Institutes at work

The Indian Institute of Ecology and Environment, Delhi, was established in 1980 and is involved mainly in research, training and arranging workshops and seminars. This institute has published the International Encyclopaedia of Ecology and Environment.

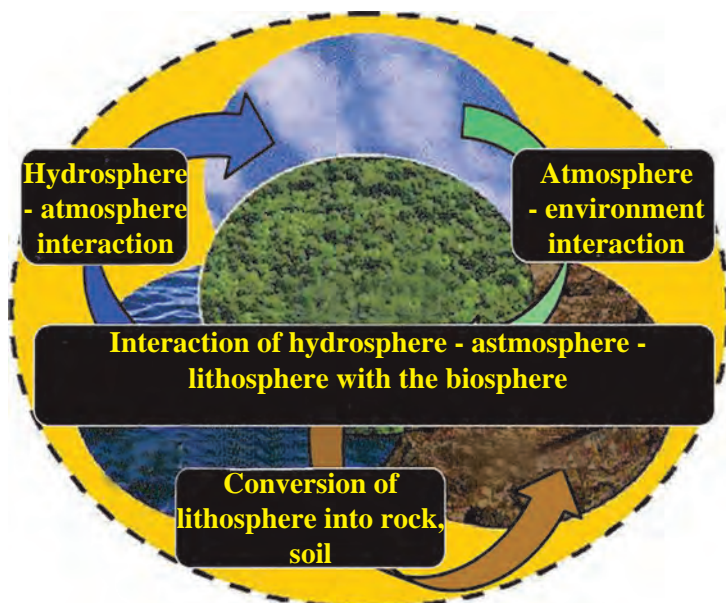

Bio-geo-chemical cycle

Though the energy flow in an ecosystem is one way, the flow of nutrients is cyclical. All organisms need nutrients for their growth. Study the various components in the figure given alongside and explain the bio-geo-chemical cycle in your own words.

The cyclical flow of nutrients within an ecosystem is called the bio-geo-chemical cycle.

7.5 Bio-geo-chemical cycle

Nutrients, necessary for the growth of organisms are continuously transferred from abiotic to biotic factors and biotic to abiotic factors within an ecosystem. This cycle operates continuously through the medium of the biosphere formed by the lithosphere, atmosphere and hydrosphere. The recycling of biological, geological and chemical sources of nutrients in this process is a complex process and depends upon the level of energy transfer in the ecosystem.

Types of bio-geo-chemical cycles

Gaseous cycle	Sedimentary cycle
<ul style="list-style-type: none"> * An accumulation of the main abiotic gaseous nutrient materials is found in the earth's atmosphere. * Includes nitrogen, oxygen, carbon dioxide, water vapour, etc. 	<ul style="list-style-type: none"> * An accumulation of the main abiotic nutrient materials is found in soil, sediment and sedimentary rocks, etc. of the earth. * Includes soil components like iron, calcium, phosphorus, etc.

The gaseous cycle is a speedier cycle than the sedimentation cycle. For example, if CO_2 has accumulated in an area, it is quickly dispersed with the wind or absorbed by plants.

Climatic changes and human activities seriously affect the speed, intensity and equilibrium of these cycles. Hence, various aspects of these cycles are extensively studied nowadays.



Do you know?

The cycle of gases and the sedimentary cycle cannot be completely separated from each other. For example, nitrogen is present in the form of a gas in the atmosphere and in the form of compounds like nitrogen oxide in the soil and sediments. Similarly, carbon occurs in abiotic form mainly in coal, granite, diamond, limestone, etc. in the earth's crust and in the form of carbon dioxide gas in the atmosphere. Generally, carbon is present in plants and animals for a much shorter duration than it is in coal.

The carbon cycle

The circulation and recycling of carbon from the atmosphere to living organisms and after their death back to the atmosphere is called the carbon cycle. Abiotic carbon atoms are circulated and recycled into biotic form mainly through photosynthesis and respiration. Hence, the carbon cycle is one of the important bio-geo-chemical cycles.

Plants convert carbon dioxide into carbohydrates by the process of photosynthesis. Similarly, they produce carbon compounds like proteins and fats, too. Herbivores feed upon plants. Carnivores feed upon herbivores. In this way, biotic carbon is transported from plants to herbivores, from herbivores to carnivores and from carnivores to apex consumers.

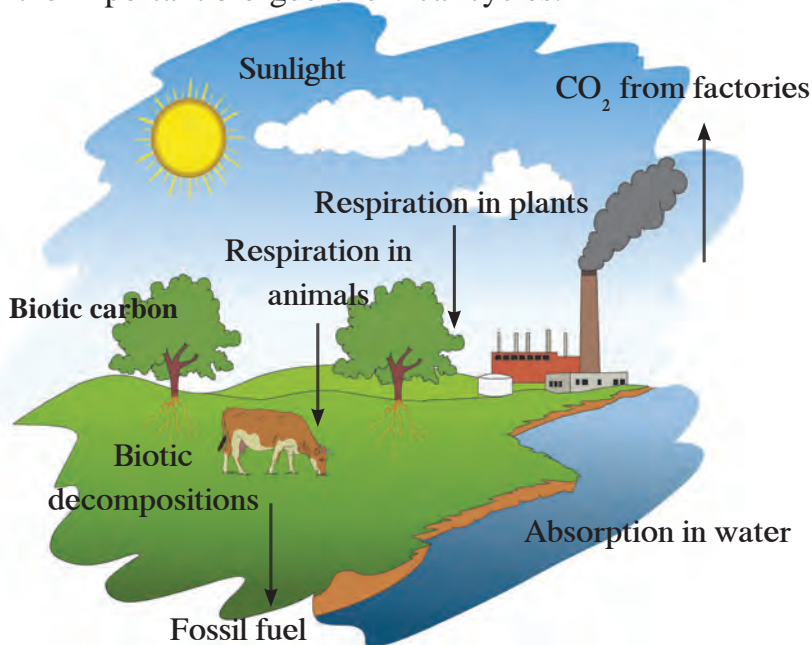

7.6 The carbon cycle

Main processes in the carbon cycle

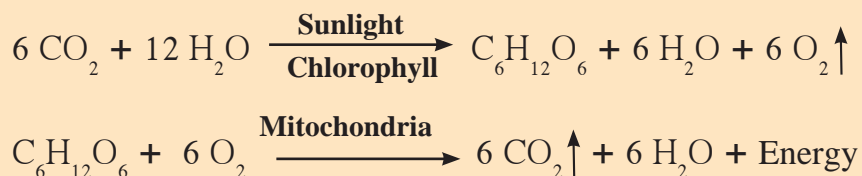

Eventually, after death, all types of consumer, are decomposed by decomposers like bacteria and fungi and carbon dioxide is released again into the atmosphere and is used again by living organism. In this way, carbon is continuously passed on from one living organism to another. After the death of living organisms, carbon goes to the atmosphere and is again taken up by living organisms.



Do you know?

Carbon dioxide is released into the atmosphere through abiotic processes like burning of fossil fuels and wood, forest fires and volcanic activity. Oxygen is released into the atmosphere by the biotic process of photosynthesis and CO_2 through respiration. The equilibrium of oxygen and carbon dioxide gases in the atmosphere is maintained by plants.



Think about it

1. The carbon cycle is very effective in the temperate region. Why is it so?
2. Even though the carbon content on earth is constant, why is there a rise in temperature due to carbon dioxide?
3. Identify the relationship between carbon in the air and the rise in atmospheric temperature.

The oxygen cycle

Oxygen forms 21% of the atmosphere. It is also present in the hydrosphere and lithosphere. Circulation and recycling of oxygen within the biosphere is called the oxygen cycle. This cycle, too, includes both the biotic and abiotic components. Oxygen is continuously produced as well as used up in the atmosphere.

Oxygen is highly reactive and it readily reacts with other elements and compounds. As oxygen is found in various forms like molecular oxygen (O_2), water (H_2O), carbon dioxide (CO_2), inorganic compounds, etc. the oxygen cycle of the biosphere is extremely complex. Oxygen is released in the process of photosynthesis whereas it is used up in processes like respiration, combustion, decomposition, corrosion, rusting, etc.

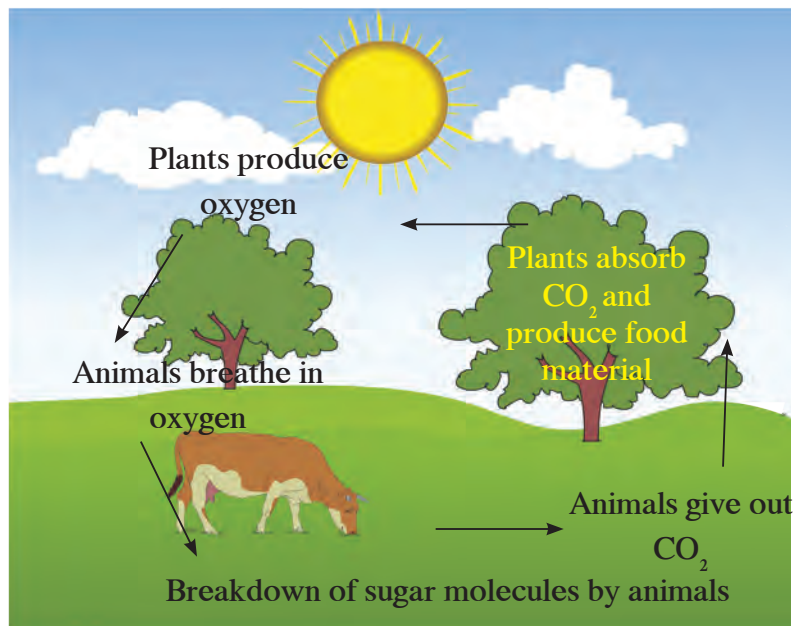

7.7 The oxygen cycle



Do you know?

Most micro-organisms use oxygen for respiration. Such microbes are called aerobes. Microbes which do not need oxygen are called anaerobes. Oxygen is important for the synthesis of proteins, carbohydrates and fats. It is also used in various chemical reactions. Ozone (O_3) is produced from oxygen through various atmospheric processes.



Can you recall?

1. What is meant by nitrogen fixation?
2. Which microbes bring about the process of nitrogen fixation?

Nitrogen forms 78% i.e. the maximum portion of the atmosphere. It is necessary for the maintenance of the cycle of nature. The circulation and recycling of nitrogen gas into the form of different compounds through various biotic and abiotic processes in nature is called the nitrogen cycle.

The nitrogen cycle

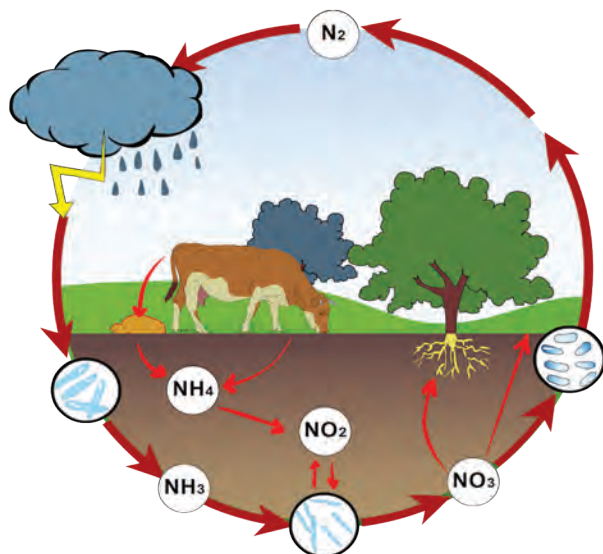

7.8 The nitrogen cycle

All organisms participate in the nitrogen cycle. It is an important component of proteins and nucleic acids. As compared to other elements, it is inactive and does not easily combine with other elements. Most organisms cannot use the free form of nitrogen.

Important processes of the nitrogen cycle

1. Nitrogen fixation: Conversion of nitrogen into nitrates and nitrites through atmospheric, industrial and biological processes.
2. Ammonification: Release of ammonia through decomposition of dead bodies and excretory wastes of organisms.
3. Nitrification: Conversion of ammonia into a nitrite and then nitrate.
4. Denitrification: Conversion of nitrogen compounds into gaseous nitrogen.



Research

Surf the internet for information about processes in the oxygen cycle and carbon cycle similar to those of the nitrogen cycle.



Exercises

1. Complete the following table (Carefully study the carbon, oxygen and nitrogen cycles).

Bio-geo-chemical cycles	Biotic processes	Abiotic processes
1. Carbon cycle		
2. Oxygen cycle		
3. Nitrogen cycle		

2. Correct and rewrite the following statements and justify your corrections.
 - a. Carnivores occupy the second trophic level in the food chain.
 - b. The flow of nutrients in an ecosystem is considered to be a 'one way' transport.
 - c. Plants in an ecosystem are called primary consumers.
3. Give reasons.
 - a. Energy flow through an ecosystem is 'one way'.
 - b. Equilibrium is necessary in the various bio-geo-chemical cycles.
 - c. Flow of nutrients through an ecosystem is cyclic.
4. Explain the following cycles in your own words with suitable diagrams.
 - a. Carbon cycle.
 - b. Nitrogen cycle.
 - c. Oxygen cycle.
5. What would you do to help maintain the equilibrium in the various bio-geo-chemical cycles? Explain in brief.
6. Explain in detail the inter-relationship between the food chain and food web.
7. State the different types of bio-geo-chemical cycles and explain the importance of those cycles.
8. Explain the following with suitable examples.
 - a. What type of changes occur in the amount of energy during its transfer from plants to apex consumers?
 - b. What are the differences between flow of matter and of energy in an ecosystem? Why?

Activities :

1. Prepare a model based on any natural cycle and present it in a science exhibition.
2. Write a paragraph on 'Balance in an Ecosystem'.



8. Useful and Harmful Microbes



- Useful micro-organisms : *Lactobacilli*, *Rhizobium*, *Yeast*
- Harmful micro-organisms : *Clostridium* and others.



Can you recall.

1. What is meant by microbes? What are their characteristics?
2. How did you observe microbes?

You are familiar with different types of microbes which are all around us but cannot be seen with our eyes. In what way are they related to our everyday life?

Useful micro-organisms



Try this



8.1 Lactobacilli

Lactobacilli

Smear a drop of fresh buttermilk on a glass slide. Stain it with methylene blue and put a coverslip over it.

Observe the smear under the 10X objective of a compound microscope and then with the more powerful 60X objective.

Did you notice the blue rod-shaped organisms moving around? They are lactobacilli, a kind of bacteria. They are minute and rectangular in shape. Lactobacilli are anaerobic bacteria i.e. they can produce energy without the use of oxygen.



Can you tell?

How is yoghurt made from milk? What exactly happens in this process?

The lactobacilli convert lactose, the sugar in the milk, into lactic acid. This process is called fermentation. As a result, the pH of milk decreases causing **coagulation** of milk proteins. Thus, milk proteins are separated from other constituents of milk. This is what happens when milk changes into yoghurt. Yoghurt has a specific sour taste due to lactic acid. The low pH destroys harmful microbes present in the milk.



Use your brain power !

1. Why do doctors advise you to have yoghurt or buttermilk if you have indigestion or abdominal discomfort?
2. Sometimes, yoghurt becomes bitter and froths up. Why does this happen?
3. Which different milk products are obtained at home by fermentation of the cream from the milk?



Do you know?

What is meant by 'probiotic' yoghurt and other foodstuffs that are popular nowadays?

Useful microbes like lactobacilli are added to these eatables. Such eatables are healthy because they kill the harmful bacteria like clostridium in the alimentary canal and help to improve our immunity.

Uses of Lactobacilli :

1. Various milk products like yoghurt, buttermilk, *ghee*, *cheese*, *shrikhand*, etc. can be obtained by fermentation of milk.
2. Lactobacilli fermentation is useful for large scale production of cider, cocoa, pickles of vegetables, etc.
3. Lactobacilli and some other useful microbes taken together are used to treat abdominal discomfort.
4. Leavened fodder offered to domestic cattle like cows and buffalos, is fodder fermented with the help of lactobacilli.
5. The lactobacilli fermentation process is used to make wine and some types of bread.



Research

1. How many different industries depend upon the lactobacilli bacteria?
2. Which types of cottage industries and factories can be started in areas with abundant milk production?

Rhizobium : Symbiotic bacteria



Let's try this

Take a plantlet of fenugreek, groundnut or any other bean and sterilize it with a 3 to 5 % solution of hydrogen peroxide.



Rhizobium

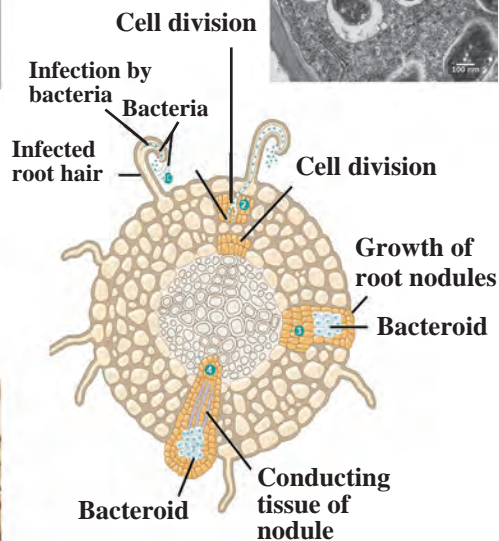
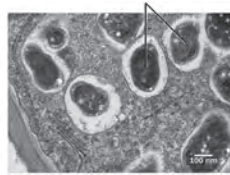

Afterwards, keep it in a 70% solution of ethyl alcohol for 4 to 5 minutes. Clean the roots with sterile water and take thin sections of the root nodules. Select good section and place it in a solution of safranin for 2 to 3 minutes. Place the stained section on a glass slide, cover it with a coverslip and observe it under the compound microscope. The pinkish rod-shaped organisms are the rhizobium bacteria.

Note that we had to search for the root nodules of leguminous plants to obtain these bacteria. Are the rhizobium bacilli useful to these plants or harmful?



8.2 Root nodules of soybean plant

Role and importance of rhizobium

Rhizobia living in root nodules supply nitrates, nitrites and amino acids to that plant and in exchange get energy in the form of carbohydrates from it. Such a mutually beneficial relationship is called symbiosis.

Rhizobia produce nitrogenous compounds from atmospheric nitrogen. However, for this process of nitrogen fixation, they need leguminous plants like beans, sweet pea, soybean, etc. as 'host'. Beans and pulses are rich in proteins due to the nitrogenous compounds made available by rhizobia.

After harvesting a leguminous crop, the left over roots and other plant parts are deliberately dumped in farm soil to maintain its bacterial population. The use of rhizobium has helped to reduce the use of chemical fertilizers and thereby their adverse effects. It has also helped to reduce expenses on fertilizers and thus works to the benefit of farmers.

Yeast



Let's try this

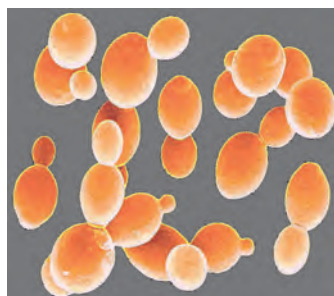

Fungus cells

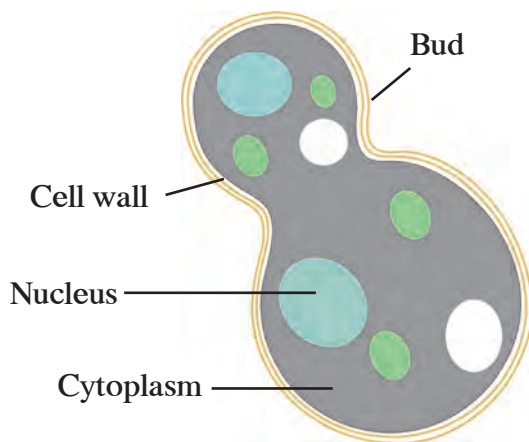

8.3 Yeast cells

In the above experiment, yeast grows and multiplies very quickly due to the carbon compounds in the sugar solution. In the process of obtaining nutrition, yeast cells convert the carbohydrates in that solution into alcohol and carbon dioxide. This process called fermentation.

How is bread made ?

Find out how to use the solution prepared in the above experiment, to make bread. Follow the recipe and make the bread. Find out and note down the reasons why the dough rises and makes the bread spongy.

Nowadays, seeds are coated with rhizobial solution or powder before sowing. After sowing, rhizobia enter the plantlets. This is called 'rhizobial inoculation'. This experiment has helped in the supply of nitrogen to cereal and other crops, besides leguminous crops.

Activity : Bring 'active dry yeast' from the market. Mix a spoonful of yeast, two spoonfuls sugar with a sufficient quantity of lukewarm water in a bottle. Fix a colourless, transparent balloon on the mouth of that bottle.

What changes do you observe after 10 minutes? Mix limewater with the gas accumulated in the balloon. Collect that limewater in a beaker and observe it. What do you notice?

Take a drop of the solution from the bottle on a glass slide, put a cover-slip over it and observe it under the compound microscope. Store the solution in the bottle carefully.

Do you see the colourless, oval cells of yeast on the slide? Some of those cells may have small round bodies attached to them. These are new daughter cells of yeast in the process of formation.

This method of asexual reproduction is called '**budding**'. Yeast is a heterotrophic fungal microbe that grows on carbon compounds.

Yeast is a unicellular fungus with 1500 different species in existence. The yeast cell is a eukaryotic type of cell.



Do you know?

Often, alcohol is produced along with sugar in sugar factories. Molasses is produced from sugarcane juice. It is rich in carbohydrates. Molasses is fermented with the help of the yeast called *Saccharomyces*. In this process, ethanol (C_2H_5OH) alcohol is produced as a primary product and ester and other alcohols as secondary products.

Spirit and other alcohols can be obtained from ethanol. Ethanol is also a smokeless and high quality fuel. Besides molasses, maize, barley, and other grains are also used for industrial production of ethanol.

Glucose and fructose, the sugars present in grape juice, are also fermented with the help of yeast to produce the alcohol which is used for making wines.



Use your brain power !

1. Recently, it has been made compulsory in India and some other countries to mix 10% ethanol with fuels like petrol and diesel. What is the reason for this?
2. Why are wineries located near Nashik in Maharashtra?
3. Chapattis made from wheat only swell up but bread becomes spongy, soft and easy to digest. Why is it so?

Bio-remediation

A yeast, *Yarrowia lipolytica* is used to absorb the toxins released during the production of palm oil and the heavy metals and minerals released in some other industrial processes. *Saccharomyces cereviceae* is used for absorption of a pollutant, arsenic.

Oil spills in oceans are cleaned with the help of *Alcanivorax* bacteria.

Antibiotics

Carbon compounds obtained from some bacteria and fungi for destroying or preventing the growth of harmful micro-organisms are called 'antibiotics'. Antibiotics, a discovery of the 20th century, have brought about a revolution in the field of medicine. Even a disease like tuberculosis has been almost completely eradicated from some countries.

Antibiotics mainly act against bacteria. Some antibiotics can destroy protozoa. Some antibiotics are useful against a wide variety of bacteria. They are called **broad-spectrum antibiotics**. Examples are ampicillin, amoxicillin, tetracycline, etc. When the pathogen cannot be identified even though the symptoms of disease are visible, broad spectrum antibiotics are used.

Whenever a pathogenic micro-organism is definitely known, then **narrow-spectrum antibiotics** are used. Examples are penicillin, gentamycin, erythromycin, etc.

Institutes at work

The National Institute of Virology, established in 1952 in Pune, undertakes research related to diseases like measles, jaundice, fever and diseases of the lungs, with support from the World Health Organization.

Penicillin

Penicillin is a group of antibiotics obtained from a fungus, *Penicillium*, and is used for controlling the infections caused by bacteria like Staphylococci, Clostridia, Streptococci, etc. Medicines containing penicillin are useful to treat certain bacterial infections of the ear, nose, throat and skin as well as diseases like pneumonia and scarlet fever.

Caution

- * Antibiotics should be taken only when prescribed by a doctor.
- * Don't purchase any antibiotic from medical stores without a prescription from a doctor.
- * Don't consume antibiotics on your own to treat common diseases like a throat infection, common cold or influenza.
- * Even if you feel well before completing of the prescribed course of the antibiotic you must continue and complete it.
- * Don't suggest to others the antibiotics which were useful to you.

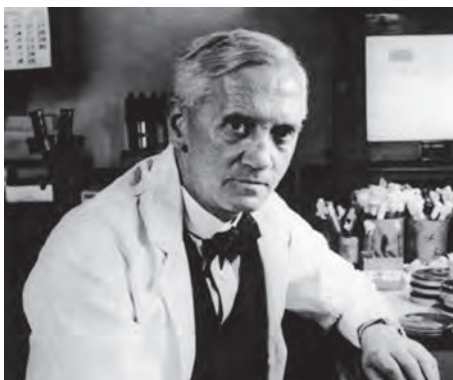

Dr Alexander Fleming

Introduction to scientists

Alexander Fleming, a professor of microbiology at St Mary's Hospital had cultured varieties of bacteria and fungi in Petri dishes in his laboratory.

On 3 September 1928, while observing staphylococci cultures, he made an interesting observation in one Petri dish. In that Petri dish, fungal colonies had grown but the area around those colonies was clean and clear. i.e. bacteria had actually been destroyed. After further studies, he confirmed that the fungus growing there was *Penicillium* and its secretion had destroyed the bacterial colonies.

Thus, the first antibiotic - penicillin had been discovered accidentally and this formed the basis for attempts to find cures for incurable diseases.

Shouldn't we always be grateful to Alexander Fleming for discovering the life-saving antibiotics?

Wonderful to know

Ants grow fungi in their termitarium (anthill) and obtain food from it. Some species of wasps and other insects lay their eggs in the fungal bodies growing on trees thus ensuring a food supply for their larvae.

Harmful micro-organisms

Fungi



Can you tell?

1. Which changes do you notice in leather articles and gunny (jute) bags during the rainy season?
2. For how long afterwards can you use those articles?
3. Why do these articles not get spoilt during the summer or winter?

Microscopic spores of fungi are present in the air. If there is sufficient moisture, spores germinate on cotton fabric, gunny bags, leather, wooden items, etc. The fungal hyphae (fibres of the fungus) penetrate deep into the material to obtain nutrition and to reproduce. This causes the materials to wear and become weak. As a result, gunny bags, leather items like shoes, purses, belts, etc. on which fungi have grown do not last long. Wooden items also get spoilt.



Think about it

Sometimes, you may notice a black powder or white discs floating on the pickle or *murabba*, when a jar is opened after a long time. What exactly is this? Why are such food items not good to eat?

Various species of fungi grow on food items like pickles, *murabba*, jam, sauce, chutney, etc. They use the nutrients in these food items for growth and reproduction. During this activity, fungi release mycotoxins, certain poisonous chemicals, into the food and thus food becomes poisonous. Hence, the food on which fungi have grown cannot be eaten.

Clostridium

Sometimes, cases of food poisoning occur during community feasts. How does the food become poisonous all of a sudden?

The bacteria which spoil cooked food are *Clostridium*. Out of about 100 different species of this bacterium, some are free living in the soil whereas some live in the alimentary canal of humans and other animals.

These bacteria are rod-shaped and produce bottle-shaped endospores in adverse conditions. One special characteristic of these bacteria is that they cannot withstand the normal oxygen level of the air because they grow in anaerobic conditions.

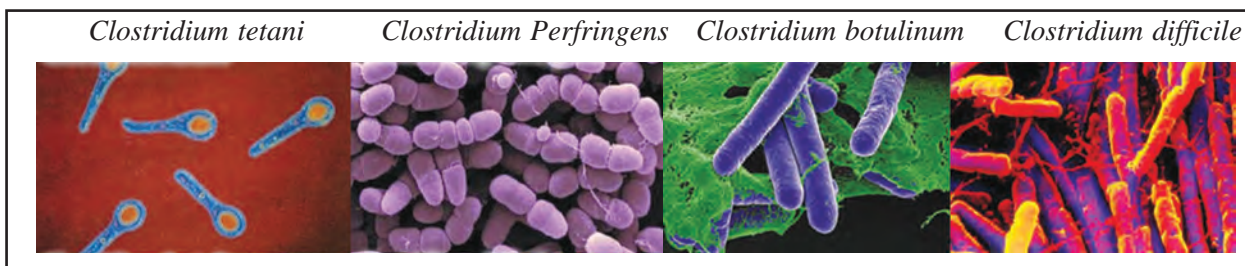

8.4 Clostridium species

Other harmful micro-organisms

Do only the *Clostridium* bacteria cause illness ?

Other kinds of micro-organisms like bacteria, viruses, protozoa and fungi are also responsible for different diseases that affect humans. You have learnt about viruses which are smaller than bacteria and can grow and reproduce only in living cells. Let us see how they are harmful to us.

An Introduction to scientists

It was believed that meat gets spoiled due to some bacteria of the bacillus type but the exact type of bacillus was not known. Van Ermengem proved that the anaerobic bacterium *Clostridium botulinum*, is responsible for food poisoning.

Ida Bengston obtained higher education in biochemistry at Chicago University. She conducted important research on the toxin responsible for gas gangrene and the antitoxin useful for treating it. While she was doing research on the dreaded disease called typhus, she herself contracted the infection. But, she overcame it and continued her research. For this work, she was honoured with the 'Typhus Medal' in 1947.

The spread and prevention of disease

Name of disease	Pathogen	Mode of infection	Preventive measures
AIDS	Virus	Through blood and semen of infected person and milk of mother suffering from AIDS.	Safe sexual contact, avoid reuse of needles and injections.
Hepatitis	Virus	Contaminated water and food.	Clean and filtered water, proper storage of food.
Influenza	Virus	Contact with infected person	Personal hygiene and avoiding contact with infected person
Measles and Chicken pox	Virus	Contact with infected person	Vaccination, uncontaminated water, clean food
Bird Flu (H_7N_9) Swine Flu (H_1N_1)	Virus	Contact with infected birds and animals	Personal hygiene, properly cooked meat.
Dengue	Virus	Mosquito bite	Cleanliness of surroundings preventing stagnation of water, mosquito control.
Pneumonia	Bacteria	Droplets spread in air by infected person	Vaccination, avoiding contact with infected person
Leprosy	Bacteria	Long term contact with infected person	Avoiding contact with infected persons and their belongings
Cholera	Bacteria	Contaminated food and water.	Clean food and water.
Malaria	Protozoa	Mosquito bite, uncleaned surroundings.	Cleanliness of surroundings, preventing stagnation of water, controlling mosquitoes.
Dandruff, ringworm, scabies	Fungi	Contact with infected person or his/her belongings like clothes.	Personal hygiene, avoiding contact with infected person



Use your brain power !



8.5 A lichen (*dagadphool*)- used as a condiment

1. Salt is applied on the inner surface of pickle jars and the pickle is covered with oil. Why is this done?
2. Which preservatives mixed with ready-to-eat foods to keep them from spoiling?
3. Find out the uses of fungi to plants and animals.
4. What is the structure of lichen, a condiment? Where else is it used?



Collect information

Which plant and animal diseases are caused by micro-organisms and what are the measures to be taken against them?



1. Complete the statements using the proper option from those given below. Explain the statements.

- (mycotoxins, budding, rhizobium)
- Yeast reproduces asexually by the method.
 - Toxins of fungal origin are called
 - Leguminous plants can produce more proteins due to

2 Write the names of microbes found in following food materials.

yoghurt, bread, root nodules of leguminous plants, idli, dosa, spoiled potato curry.

3. Identify the odd word out and say why it is the odd one?

- Pneumonia, diphtheria, chicken pox, cholera.
- Lactobacilli, rhizobia, yeast, clostridia.
- Root rot, rust (*tambora*), rubella, mozaic.

4. Give scientific reasons.

- Foam accumulates on a the surface of 'dal' kept for a long time in summer.
- Why are naphthalene balls kept with clothes to be put away.

5. Write down the modes of infection and the preventive measures against fungal diseases.

6. Match the pairs.

- | ‘A’ group | ‘B’ group |
|-----------------------|------------------------------|
| 1. <i>Rhizobium</i> | a. Food poisoning |
| 2. <i>Clostridium</i> | b. Nitrogen fixation |
| 3. <i>Penicillium</i> | c. Bakery products |
| 4. Yeast | d. Production of antibiotics |

7. Answer the following questions.

- Which vaccines are given to infants? Why?
- How is a vaccine produced?
- How do antibiotics cure disease?
- Are the antibiotics given to humans and animals the same? Why?
- Why is it necessary to safely store the pathogens of a disease against which vaccines are to be produced?

8. Answer the following questions in brief.

- What are ‘broad spectrum antibiotics’?
- What is fermentation?
- Define ‘Antibiotic’.

Activity :

Collect information about generic medicines and discuss them in the class.



9. Environmental Management



- Weather and climate
- Solid waste management
- Meteorology
- Disaster management



Can you recall.

1. How does the atmosphere affect our daily life?
2. Forecasts about which weather related factors are given during the news bulletins on Doordarshan and Akashvani?

Weather and climate

Atmospheric conditions at a specific time at a particular place are referred to as weather. Atmospheric conditions depend upon a variety of factors. (Figure 9.1)

We frequently express our opinion about the weather by making statements like, 'Today, it is too cold' or 'It is very hot today.'

Weather depends upon the prevailing conditions of the air. The climate of a particular region is the average of daily readings of various weather-related parameters recorded for several years. Hence, climate is a long term predominant condition of the atmosphere.

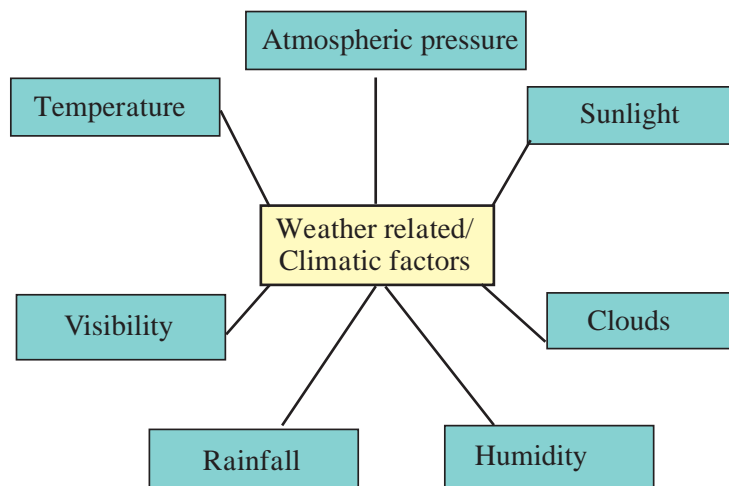

9.1 Weather-related / climatic factors

Changes in weather

Climate does not change continuously. Climate is that which remains constant in a region for a long duration. Thus we see that weather is related to a specific location and specific time whereas climate is related to a longer duration and larger area. Changes in the weather may occur for short periods of time whereas changes in the climate take place slowly over a much long duration.

Climate plays a very important role in our day to day life. It influences our basic needs like food, clothing and shelter as well as our occupations. Climate is especially important for an agrarian country like India. Various climatic factors like direction and speed of wind, temperature, atmospheric pressure, etc. are considered during construction of runways, seaports, huge bridges and skyscrapers, etc.



Use your brain power !

Which factors are affected favourably or unfavourably by climate? What must we do to minimize this effect?



Think and discuss.

1. Human progress is related to a conducive climate and geography.
2. Human beings have designed a time schedule for their lives based upon centuries of climatic experiences.
3. Scientists find it necessary to study climate in view of its effect on agricultural production.

A special day

23rd March is observed as 'World Meteorological Day'.

Collect information about Meteorology and prepare charts to create awareness about it.

Importance of weather in the living world

1. Daily weather as also long term climatic conditions influence human lifestyle directly or indirectly. Land, water bodies, plants and animals collectively form the natural environment on earth. This environment is responsible for the development of organisms.
2. The climate of a particular region helps to determine the diet, clothing, housing, occupations and lifestyle of the people of that region. For example, the characteristic lifestyle of Kashmiri and Rajasthani people.
3. Salinity of marine water, formation of oceanic currents, water cycle, etc. are all related to various weather and climatic factors.
4. Various climatic factors bring about the weathering of rocks in the earth's crust.
5. Climate plays a very important role in the formation and enrichment of soil.
6. Microbes in the soil play an important role in formation of organic materials. This process depends upon various climatic factors.

Thus, it is very clear that the study of meteorology is very important from the view point of human life.

While ascertaining the climate of a particular region, a review of earlier studies of various aspects of climate is very important. Most countries in the world have established meteorology departments for making and recording such observations. These departments have 'observatories' which are equipped with modern instruments and technology.

If present climatic conditions are analysed with reference to the past climatic conditions, we can predict climatic changes of the future. However, as climate is the net result of a complex mixture of various atmospheric factors, forecasting it is very complicated and difficult. Forecasting is easy for places where climatic changes are slow and of a limited nature. However, where climatic changes are complex, interdependent and rapid, making forecasts is very difficult.

Meteorology

The science that studies the inter-relationships between the various components of air, natural cycles, geological movements of the earth and climate is called meteorology.

Meteorology includes the study of storms, clouds, rainfall, thunder, lightning, etc. Depending upon the study of such factors, weather forecasts are made. They are useful to common people, farmers, fisheries, aviation services, water transport and various other organizations.

Institutes at work

The World Meteorological Organization was established by the United Nations Organization on 23rd March 1950. This organization plays an important role in food security, water management, transportation and communication.

Using ICT

With the help of various search engines on the Internet, search for links giving information about the following institutes and prepare a report based upon the information obtained.

World Meteorological Organization (WMO)

Indian Institute of Tropical Meteorology (IITM)

National Oceanographic and Atmospheric Administration. (NOAA)

India Meteorological Department

The India Meteorological Department was founded by the British in 1875 at Shimla. Its head office is at New Delhi and its Regional Offices are at Guwahati, Mumbai, Kolkata, Chennai, Nagpur and New Delhi. Maps are prepared every day which indicate the daily predictions about the weather. Such maps are prepared and published twice in every 24 hours. In this institute, research goes on continuously on various aspects like instruments for climatic readings, predictions about climate made using radar, predictions about climate related to siesmology, predictions regarding rainfall by satellites, air pollution, etc.

The India Meteorological Department provides important information regarding weather and climatic conditions to other departments like aviation, shipping, agriculture, irrigation, marine oil exploration and production, etc. Predictions regarding calamities like dust storms, sand storms, heavy rainfall, hot and cold waves, tsunami, etc. are communicated to various departments, all types of mass communication media and all citizens. For this purpose, India has launched several satellites equipped with highclass technology. Observatories at several locations are doing excellent work in the analysis of the information received from these satellites. (www.imdpune.gov.in)

Monsoon model and climate prediction

The tradition of forecasting the monsoon season in India is older than 100 years. After the famine of 1877, H. F. Blanford, the founder of IMD had made such a prediction for the first time taking the snowfall in the Himalayas as a parameter for this prediction. In the decade of the 1930's the then director of IMD, Sir Gilbert Walker had underlined the relationship between various worldwide climatic factors and the Indian monsoon, and, based on available observations and previous recordings related to this relationship he put forth a hypothesis regarding the nature of the monsoon. With the initiative of Dr Vasant Rao Govarikar in the decade of the 1990's a monsoon model based upon 16 worldwide climatic parameters was developed. This model was in use from 1990 to 2002.

Mathematical model (Dynamic)

Forecasts are made with the help of mathematical models which take into account estimates of current weather related events and ongoing physical interactions between them. Data about current climatic parameters is mathematically analysed with the help of the Param supercomputer. Various mathematical models based upon daily geographic events are developed by supercomputer technology.

Presently, new models are being developed at the IITM. Work is in progress at two levels, namely, designing new models and developing new technology. The main focus is on development of the radar system and satellite technology.



Always remember

Any meteorological model depends upon the inter-relationship between parameters used in that model and the results expected from it. However, as these inter-relationships with reference to the ocean and atmosphere are never constant, meteorological models need to be changed continually.

Holistic model

In this model, predictions are based upon those parameters used in other models which have the greatest effect on the monsoon. Nowadays, predictions declared by IMD are the collective outcome of various models. This is called a holistic model.

Statistical model : In this model, current climatic observations in a region are compared with earlier parameters such as oceanic temperature, atmospheric pressure and the nature of the monsoon rainfall of several years. This data is comparatively analysed by statistical methods and predictions are made about the monsoon in the present conditions.

Solid waste management : need of the hour



Can you tell?

1. What is meant by pollution?
2. In which different ways do our surroundings get polluted?



Try this

Observe the garbage collected in the dustbin of your classroom and make a list of the various materials in it. Discuss with your teacher, how these materials can be properly disposed of.

Can we do the same with the garbage generated in our house? Think about it.



9.2 Solid waste



Observe and discuss.



A



B

9.3 Area with garbage vs clean area

1. What is main difference between what we see in the two pictures alongside (9.2 A and B)?
2. What should we do to permanently maintain the condition seen in picture B?

Many waste materials are generated through the various daily human activities. This is called solid waste. If these waste materials are properly disposed of, they can be a valuable source of energy. Currently, solid waste is a serious world wide problem as it causes both water and soil pollution. Solid waste is also serious problem from the point of view of economic growth, environmental degradation and health. It has posed a serious threat to nature and human habitat because of the air, water and soil pollution it causes.



Do you know?

Garbage production per day

Solid waste generated in the main metro cities of the state is approximately as follows-
Mumbai: 5000 tons, Pune: 1700 tons, Nagpur : 900 tons.

On 26th July 2005, a serious flood calamity had arisen in Mumbai. Improper solid waste management was one of the main reasons behind that calamity. Thus we see that accumulation of solid waste can lead to various calamities.



Observe

Make a survey of the building or area where you live. Categorise the garbage as degradable and non-degradable waste. Approximately, how much solid waste is generated in a week? Make a list of the factors responsible for it.



Can you tell?

1. What is meant by solid waste?
2. What are the different things included in solid waste?

We make use of many materials and articles in our daily life. They are of different kinds. Some of them are reusable but others have to be discarded. However, if they are not properly disposed of, it affects the environment adversely.



Make a list and discuss

Read the following table carefully. What do you notice?

Classification	Source
Domestic waste	Waste food, paper, plastic paper, plastic bags, vegetable waste, fruit skins, glass and sheet metal articles, etc.
Industrial waste	Chemicals, pigments, sludge, ash, metals, etc.
Hazardous waste	Chemicals generated in various industries, radioactive materials, explosives, infectious materials, etc.
Farm/Garden waste	Leaves, flowers, branches of trees, crop residues like straw, animal urine and dung, pesticides, remains of various chemicals and fertilizers, etc.
Electronic waste	Non-functional TV sets, cell phones, music systems, computers and their parts, etc.
Biomedical waste	Bandages, dressings, gloves, needles, saline bottles, medicines, medicine bottles, test tubes, body parts, blood, etc. from clinics, hospitals, blood banks and laboratories.
Urban waste	Waste generated through household industries and large commercial and industrial establishments, carry bags, glass, metal pieces and rods, threads, rubber, paper, cans from shops, vegetable and meat markets, construction waste, etc.
Radioactive waste	Radioactive materials like Strontium-10, Cerium-141, Barium-140 and heavy water, etc. generated from atomic energy plants, uranium mines, atomic research centres, nuclear weapons testing sites, etc.
Mining waste	Remains of heavy metals like lead, arsenic, cadmium, etc. from mines.



Think about it.

Into which two categories can the waste materials in the lists above be classified?

Biodegradable waste : This type of waste is easily degraded by microbes. It mainly includes kitchen waste (spoiled food, fruits, vegetables) ash, soil, dung, parts of the plants, etc. This waste is mainly of organic type and is also called ‘**wet solid waste**’ or ‘**wet garbage**’. If it is carefully decomposed, we can get compost and fuel of good quality from it. Such bio-fuel projects have been started in many cities.

Non-biodegradable waste : This type of waste is not easily degraded because it requires a very long period of time and the use of various techniques. It includes plastic, metal and other similar materials. This type of waste is also called ‘**dry solid waste**’ or ‘**dry garbage**’.



Use your brain power !

1. Why is it necessary to recycle non-degradable waste?
2. Which materials are included in solid dry waste?

Make a list of various waste materials and articles in your area and prepare a chart as follows

Material	Degradable (Organic)	Non-degradable (Inorganic)	Recycling	Reuse	Toxic
Plastic bottle	No	Yes	Yes	Yes	Yes



Find out

Nowadays, an electronic device – the cell phone – is very popular. From a mobile shop near your house, find out how they dispose of old and broken down cell phones.

Using ICT

Carefully observe figure 9.4 alongside. Based on it, send an e-mail to your friend explaining the importance of solid waste management.

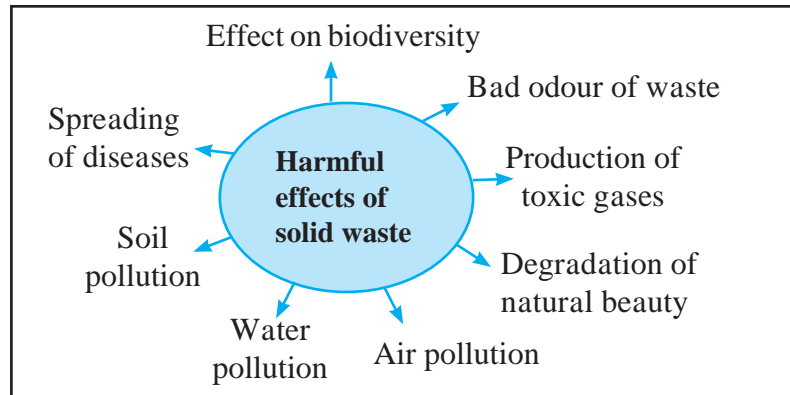

9.4 Harmful effects of solid waste

Necessity of solid waste management :

1. For preventing environmental pollution and to keep the surroundings clean.
2. For energy as well as fertilizer production and through that to generate work and employment opportunities.
3. To reduce the strain on natural resources through treatment of solid waste.
4. To improve the health and quality of life and to maintain environmental balance.

It is the need of the hour to implement solid waste management practices to avoid the possible problems due to solid waste generated from urban and industrial areas and to maintain a clean environment. For this purpose, we should implement measures like increasing the efficiency of production processes so that minimum waste will be generated, reducing garbage production by recycling and reuse of waste materials.

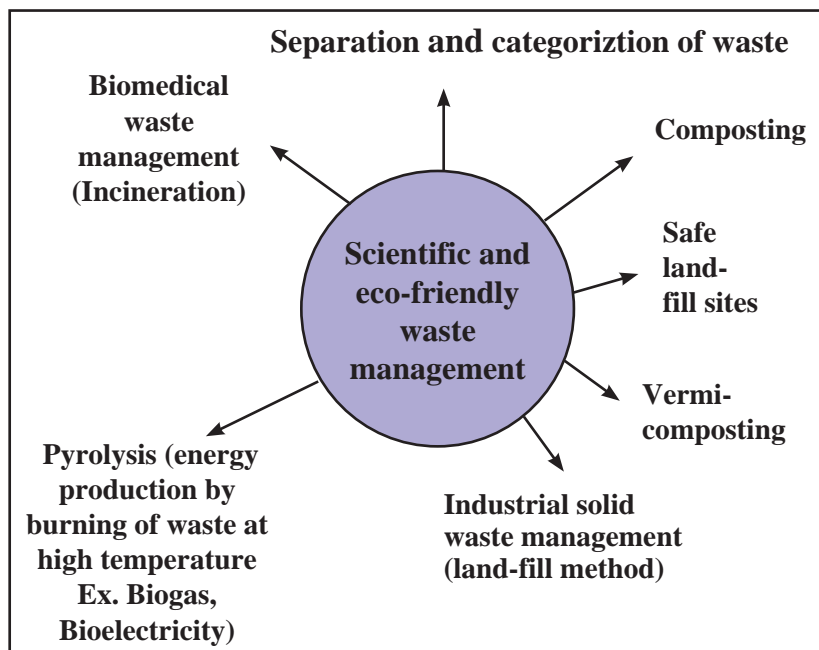

9.5 Solid waste management

7 Principles of solid waste management -

Reuse

After use materials should be reused for some other proper purposes.

Refuse

Refusal to use articles made from non-degradable articles like plastic and thermocol.

Recycle

Production of useful articles by recycling solid wastes. For example, paper and glass can be recycled.

Rethink

Rethinking our habits, activities and their consequences in connection with the use of various articles of daily use.

Reduce

Restriction on the use of resources to avoid their wastage. Old materials should be reused. One thing should be shared by many. Use and throw type of objects should be avoided.

Research

Conducting research related to reuse of materials that are temporarily out of use.

Regulation and public awareness

Following the laws and rules related to waste management and motivating others to do the same.



Think about it.

Some habits are described below. Do we have those habits? If so, how does it help in waste management?

1. Following the 3 R 'mantra': Reduce (reducing the waste), Reuse (reuse of waste) and Recycle (recycling of waste).
2. Throwing plastic wrappers of chocolates, ice-creams, biscuits, etc. into dustbins. Avoiding littering.
3. Avoiding the use of plastic bags and instead using cloth bags or bags prepared from old sarees, bed-sheets, curtains, etc.
4. Using both sides of a paper for writing. Reusing greeting cards and gift papers.
5. Avoiding use of tissue paper and preferring to use ones own handkerchief.
6. Using rechargeable batteries instead of lead batteries.
7. Implementing various programmes of solid waste management and educating, encouraging the family and society in this regard.
8. Avoiding 'use and throw' type of articles like pens, canned cold drinks, tetra-packs should be strictly avoided.

America is the largest producer of electricity from solid waste. Japan has developed the projects of production of threads, paper and other useful materials from banana peelings. Find out about such projects in our region.



Find out

Which waste management processes are used in your village / town / city?

Period required for degradation of waste–

Waste Material	Period of Natural Degradation
Banana peelings	3 – 4 weeks
Cloth bags	1 month
Rags	5 months
Woollen socks	1 year
Wood	10 – 15 years
Leather shoes	40 – 50 years
Tin cans	50 – 100 years
Aluminium cans	200 – 250 years
Certain plastic bags	10 lakh years
Thermocol/styrofoam cup	Infinite duration

If the time required for degradation of the solid waste generated around us is long, it seriously affects other environmental factors. What care will you take to avoid this?

Figure 9.5 A, below shows a method of storing waste and 9.5 B, shows the use of specific dustbins as per the type of waste. Think about how such eco-friendly waste management can be achieved by following these methods in our homes, too.



9.5 Methods of storing solid waste

A peep into the past.

Ever since ancient times, special attention has been given to garbage disposal. In the Greek city of Athens, in 320 BCE, a law had been enacted regarding garbage disposal. It made throwing garbage in the open an offence.

Disaster management



Can you recall?

1. Which natural calamities have you experienced? How did they affect the conditions in your surroundings?
2. How will you make a plan to be safe from calamities or to minimize the damage?

Various natural disasters like thunderbolts (lightning), floods, fire and man-made disasters like accidents, bomb explosions, chemical accidents in industries, stampedes in mass gatherings, riots, etc. occur around us from time to time. They cause large scale damage to life and property.



Can you tell?

What are the types of casualties that are seen to occur in different types of disasters?

First aid to disaster victims :

The main objective of first aid is prevention of death, preventing deterioration of health and starting the process of rehabilitation. Hence, it is important to know about the emergency measures or first aid practices to be followed

Basic principles of first aid :

Life and Resuscitation - ABC

- 1. Airway :** If the victim has difficulty breathing, the head should be held in a backward sloping position or the chin should be raised so that the respiratory passage remains open.
- 2. Breathing :** If breathing has stopped, the victim should be given artificial ventilation by mouth to mouth resuscitation.
- 3. Circulation :** If the victim is unconscious, then after giving mouth to mouth respiration twice, the heart should be pressed down hard by pressing the chest with both the palms. These two actions should be repeated alternately about 15 times. This is called cardio-pulmonary resuscitation (CPR). It helps to bring the circulation back to normal.

Disaster management is action implemented through proper planning, organized activity and co-ordination. It includes the following -

1. Prevention of losses and danger.
2. Improving tolerance.
3. Providing relief from disaster, minimising the intensity and extent of harm.
4. Preparation to face the disaster.
5. Immediate action in the disaster situation.
6. Assessment of damages and intensity of the disaster.
7. Arranging for rescue work and help.
8. Rehabilitation and rebuilding.



9.6 Artificial breathing

Bleeding : If the victim is injured and bleeding through the wound, then the wound should be covered with an antiseptic pad and pressure applied on it for 5 minutes with either thumb or palm.

Fracture and impact on vertebrae : If any bone is fractured, it is essential that the fractured part be immobilized. It can be done with the help of any available wooden rods/batons/rulers. If there is an impact on the back or vertebral column, the patient should be kept immobile on a firm stretcher.

Burns : If victims have burn injuries, it is beneficial to hold the injured part under clean and cold flowing water for at least 10 minutes.

For injuries like sprains, twisting and contusion, the 'RICE' remedy should be applied :

Rest : Allow the victim to sit in a relaxed position.

Ice : Apply an ice-pack to the injured part.

Compression : After the ice-pack treatment, the injured part should be massaged gently.

Elevate : The injured part should be kept in a raised / elevated position.

How to transport victims / patients?



Cradle method :
Useful for children and under-weight victims.

Carrying piggy back :
Useful for carrying patients who are unconscious.



Human crutch method : If one of the legs is injured, the victim should be supported with minimum load on the other leg.

Pulling or lifting method : This is used for carrying an unconscious patient, through a short distance.



Carrying on four-hand chair : This is useful when support is needed for the part below the waist.

Carrying on two-hand chair : Useful for those patients who cannot use their hands but can hold their body upright.



Methods used by the fire-brigade

Stretcher : In an emergency, if a conventional stretcher is not available, then a temporary stretcher can be made using bamboos, blanket, etc.

Other emergency measures: Boats are used by the civil administration to rescue people trapped in a flooded area. As an emergency measure, wooden boards, bamboo floats, air-filled rubber tube from a tyre can be used to advantage.



Find out

A fire-extinguisher is a portable appliance that can be easily carried anywhere. Various appliances are used to put out a fire. Visit the fire department in your city and collect detailed information. (For more information, refer to lesson 13.)

Exercises



1. Match the items in column ‘A’ with the proper ones in column ‘B’ and explain their impact on the environment.

Column ‘A’

1. Harmful waste
2. Domestic waste
3. Biomedical waste
4. Industrial waste
5. Urban waste

Column ‘B’

- a. Glass, rubber, carry bags, etc.
- b. Chemicals, pigments, ash, etc.
- c. Radioactive material
- d. Leftover food, vegetables, peelings of fruits.
- e. Bandages, cotton, needles, etc.



2. Complete the statements using the given options and justify those statements.

(Geographic favourability, climate, weather, observatory)

- a. Of the abiotic factors that affect biodiversity by far the most important is
- b. A description of the climatic conditions of short duration in a particular area is
- c. Irrespective of the progress of human beings, we have to think about
- d. Establishments where various climatic factors are recorded are called

3. Answer the following questions.

- a. How is first aid provided to victims of disasters who are injured?
- b. State the scientific and eco-friendly methods of waste management.
- c. Explain with suitable examples, the relationship between weather forecasting and disaster management.
- d. Why is e-waste harmful? Express your opinion about this.

e. How will you register your individual participation in solid waste management?

4. Write notes.

Meteorology, Climatic factors, Monsoon model, Industrial waste, Plastic waste, Principles of first aid.

5. Give examples of the importance of climate in the living world with explanations, in your own words.

6. Explain with suitable examples, the care to be taken when using the methods of transporting patients.

7. Explain the differences.

- a. Weather and climate
- b. Degradable and non-degradable waste

Activity :

1. Visit a nearby hospital and collect information about how waste is managed.
2. Establish a vermi compost project in your school under the guidance of your teachers.



10. Information Communication Technology : The new direction of progress



- Important components of a computer
- Different types of software
- Importance of information communication in science and technology
- Opportunities in the field of computers



Can you tell?

Which devices do we use directly or indirectly for collecting, sharing, processing and communicating information?

The term Information Communication Technology (ICT) includes communication devices and the use of those devices as well as the services provided with their help. The store of information generated due to the advances in science and technology is increasing at a tremendous rate. If we ignore this explosion in information, the knowledge that we have will become outdated.



Think about it

How is information communication technology important for dealing with the explosion of information?

Devices used in information communication technology : Different devices are used for producing information, for communicating, classifying, saving/storing information, managing information etc. For example, the telephone is used for sharing information by conversing with someone.



Complete the table

The following table has names of some ICT devices. Complete the table based on the questions asked. Also, enter the names of any additional devices that you know of.

Name of the device	What is it used for?	Where is it used?	Benefits from its use
Computer / laptop			
Mobile			
Radio			
Television set			

The computer, which is the most important device for information communication, is considered to have gone through five generations, since it was first created. The computers used during the period between 1946 and 1959 are said to be 'first generation computers.' The ENIAC computer was made in this period. Valves were used in its construction. These valves were large in size. They also consumed a lot of electricity. That generated heat and computers would shut down many times. Today's computers are 5th generation computers.



Find out

Use the Internet to collect information about all the generations of computers and their types. Make a note of the differences in their characteristics.

The entry of computers in all fields in this age of technology has been possible only due to the increased speed of computers. In which fields of work do we see computers being used?



Can you tell?

How does a computer work?

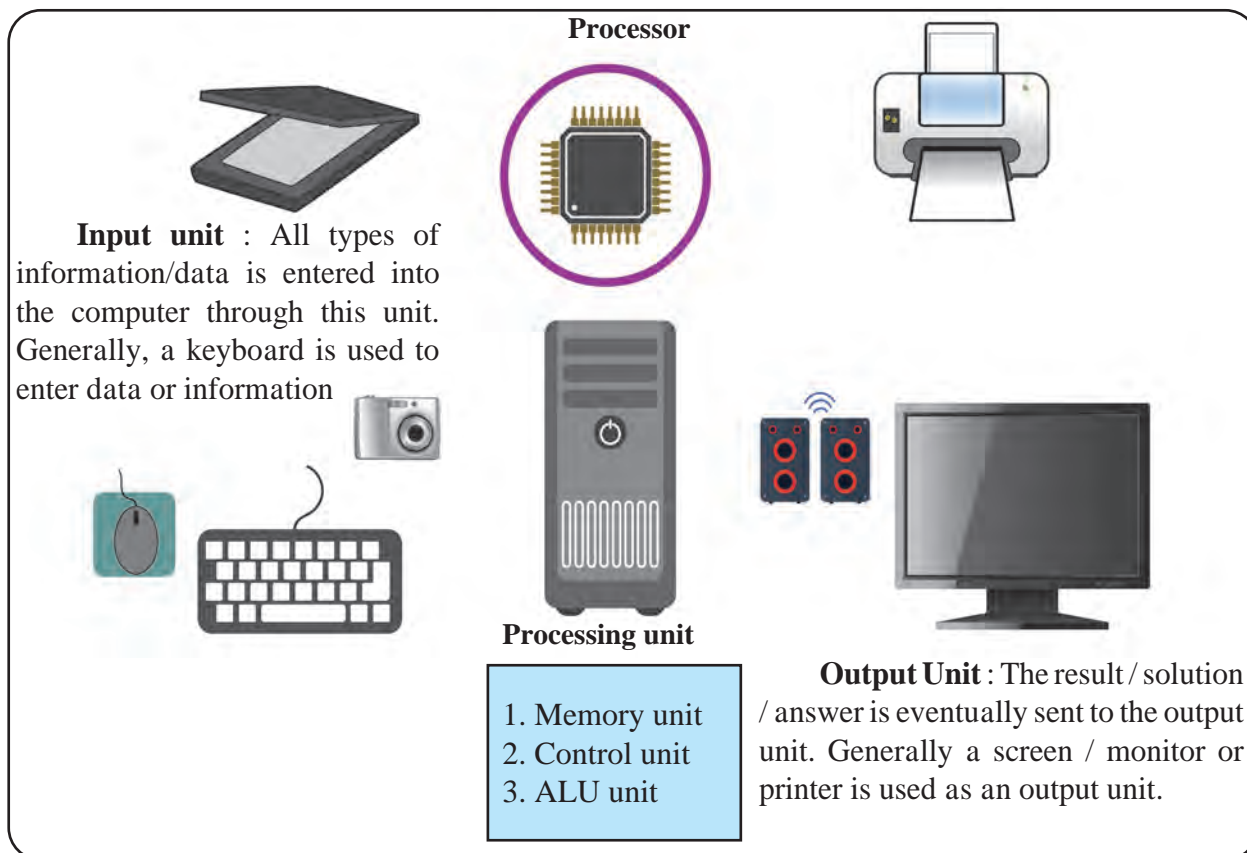

10.1 Working of a computer

Important components of a computer

Memory : Memory is the place for storing data obtained from the input and also the generated solution or answer by the computer. There are two types of memories in a computer.

1. Internal Memory
2. External Memory

The internal memory is of two types.

1. RAM (Random Access Memory): This is created from electronic components. Any electronic component can function only as long as it is supplied with electricity.

2. ROM (Read Only Memory): The information stored here can only be read. We cannot make changes to the information originally stored here.

Operating system : This is a program which provides a means of communication between the computer and the person working on it. It is called the DOS (Disk Operating System). We cannot use a computer without its operating system.

Program : A program is a group of commands to be given to a computer.

Data and information : Data is information in its raw (unprocessed) form.

Two main components of computers

Hardware : Hardware consists of all the electronic and mechanical parts used in computers.

Software : Software refers to the commands given to the computer, information supplied to it (input) and the results obtained from the computer after analysis (output).



Make a list and discuss

Make a list of the various hardware and software items of a computer and discuss their working in the class.

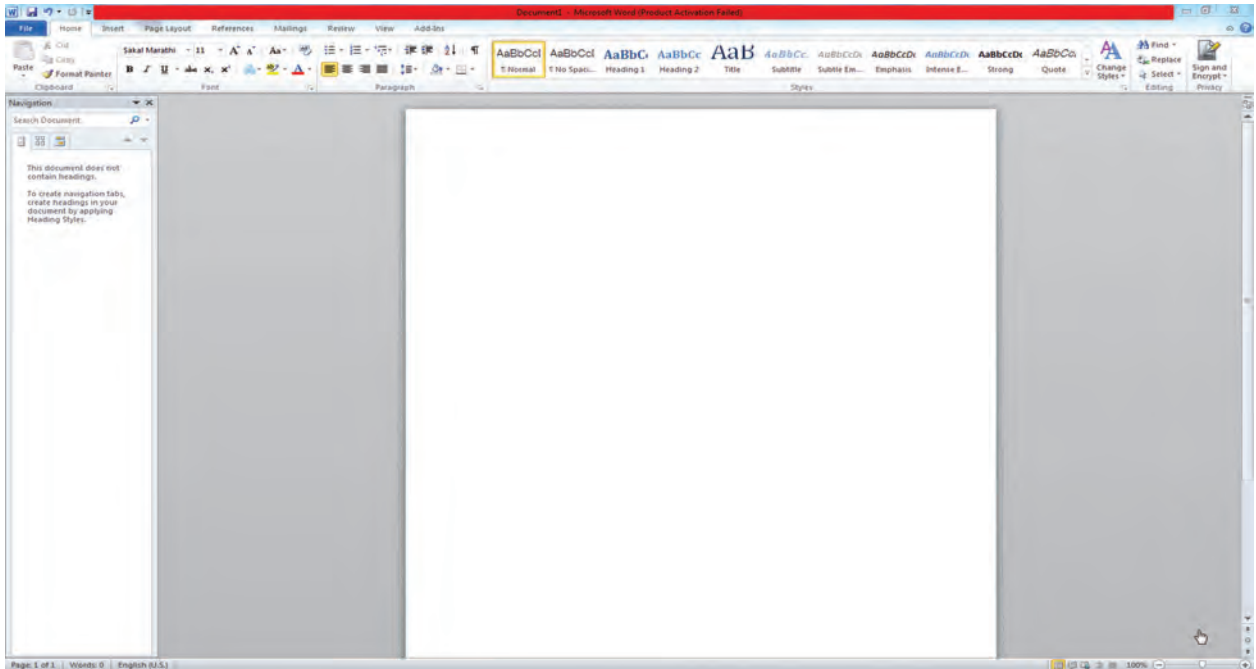

Try this

Using Microsoft Word to create a document and write equations.

1. Click on the  icon on the desktop.
2. Select the 'New' option in the 'File' tab, and then select the 'Blank document' option.
3. Type your material on the blank page on the screen using the keyboard. Use the language, font size, bold, etc. options in the Home tab to make the typed material attractive.
4. To type equations in the text, select the 'Equation' option in the 'Insert' tab.



5. Select the proper equation and type it using mathematical symbols.

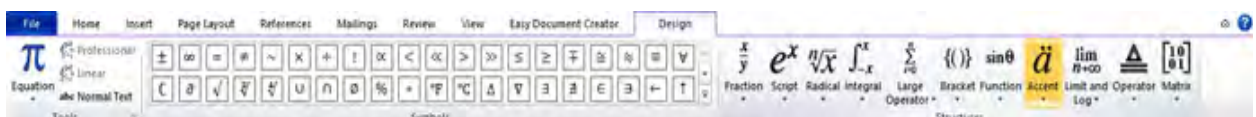

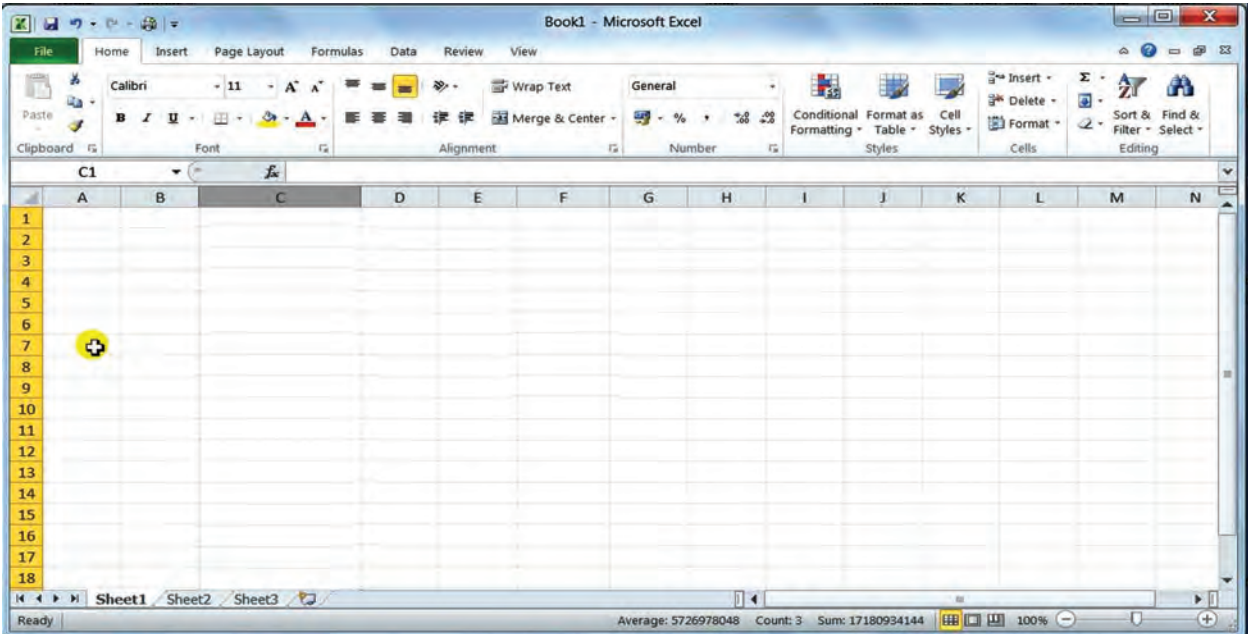

Try this

Using Microsoft Excel to draw graphs based on the obtained numerical information

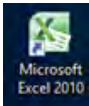
1. Click on the  icon on desktop.
2. Select the 'New' and then 'Blank' option from the 'File' tab.
3. Type the information which is to be used to draw the graph, on the 'sheet' on the screen.
4. After you have finished typing, 'Select' the information and click on the required graph in the 'Insert' tab.

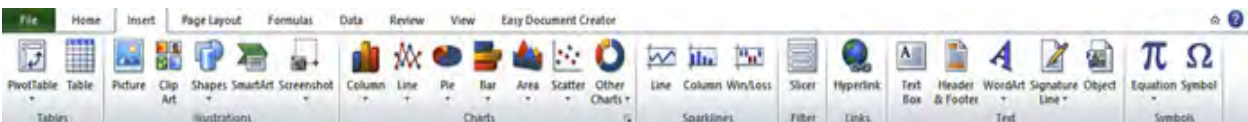

5. Analyze the information using the graph.

What precautions will you take when entering data?

1. As far as possible, the data should be kept in tabular form. Different types of data should be entered in different cells. Data should be entered neatly and in one 'flow'. Unnecessary space and special characters should not be used.
2. Many times we 'drag and fill' data. At such times, the 'smart tag' can be used after 'drag data' to fill any data in any manner as required.
3. Once the data has been entered it can be formatted in different ways. Similarly, we can perform different types of calculations, using different formulae.
4. While using a formula, the '=' sign should be typed first. Similarly, no space should be inserted while typing any formula.

Microsoft Powerpoint

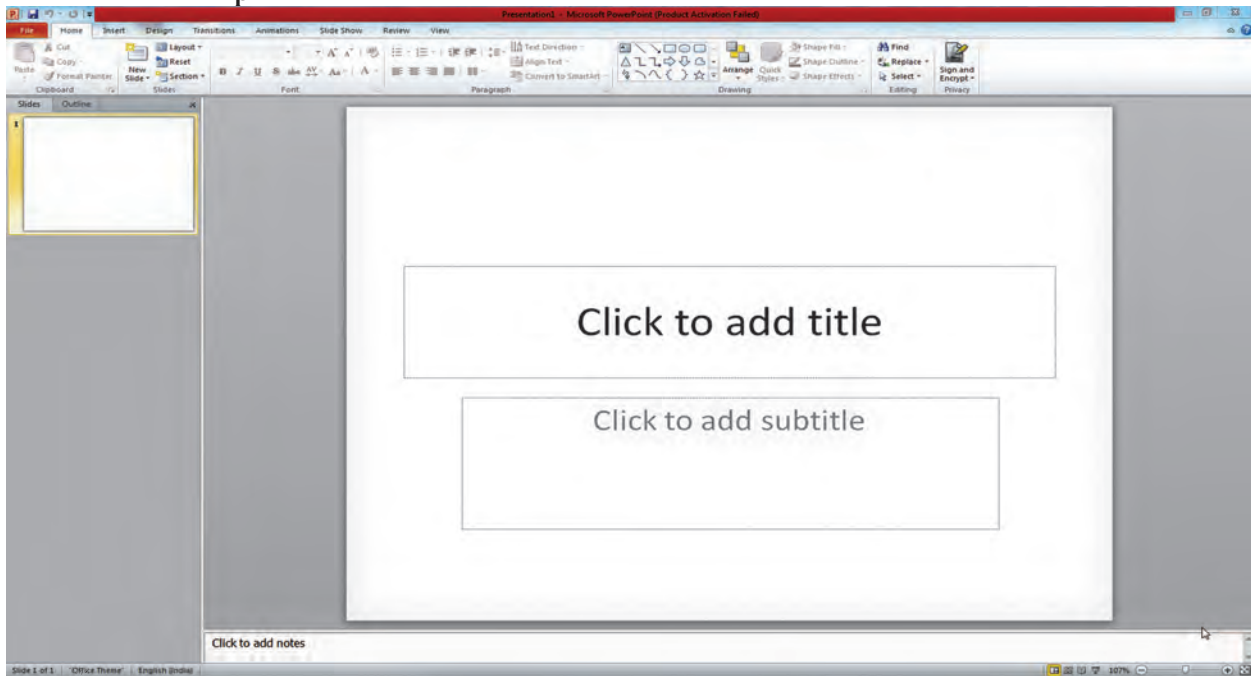

Try this

Using Microsoft Powerpoint to create a presentation



1. Click on the  icon on the Desktop.
2. You must have with you the material and pictures related to the topic on which you wish to make the presentation.
3. Select the 'New' option under the 'File' tab and choose the 'Blank slide' option. (You can select the kind of slide you need according to your presentation.)
4. Type the information you need on the blank slide and insert pictures.
5. Use the 'Design' tab to design your slide.
6. Use the 'Animation' tab to animate the slide and make a slide show.

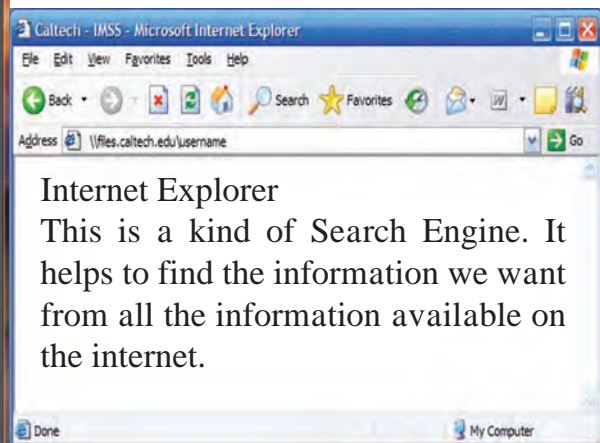
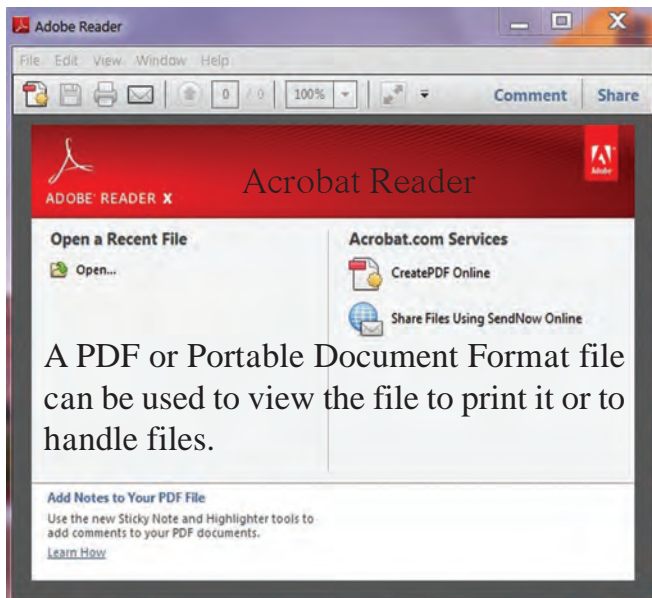

Note: While studying the subject of science and technology you have to actually make use of the information communication technology that you learnt in this lesson. Do take the help of your teachers as well as your parents and friends if you need it.

Some uses of information communication technology are given in the boxes below. What are its other uses?

Demonstration

Some experiments and concepts in science can be demonstrated easily and effectively by using simulation and animation e.g. functioning of the nervous system.

Prediction

Predictions can be made after compiling and processing information e.g. meteorology .

Collecting scientific information

Internet, emails, newsgroups, blogs, chat rooms, Wikipedia, video conferencing, etc.

Opportunities in the of computers field

- 1. Software field :** This is an important field. Having accepted the challenge of creating software, many companies have entered this field. The opportunities in the software field can be classified as follows - application program development, software package development, operating systems and utility development, special purpose scientific applications.
- 2. Hardware field :** Today, there are several companies in our country too, which make computers. They sell computers that they have themselves made. Others sell computers brought from outside as well as repair them and take maintenance contracts to keep computers in big companies working efficiently without a break. Plenty of jobs are available here. There are job opportunities in hardware designing, hardware production, hardware assembly and testing, hardware maintenance, servicing and repairs, etc.
- 3. Training :** The training of new entrants for various jobs is a vast field. It is very important to have dedicated teachers who are competent in the field of computers.
- 4. Marketing :** There are many establishments which make and sell computers and related accessories. They need good sales personnel who are experienced in the working of computers as well as skilled in marketing.

Institutes at work

C-DAC, the wellknown Centre for Development of Advanced Computing, situated in Pune, is the leading institute in India which conducts research in the field of computers. The first Indian supercomputer was made with help from this institute. Valuable guidance for making this computer (the Param computer) was received from the senior scientist Vijay Bhatkar. Param means the supreme. This computer can perform one billion calculations per second. It is used in many fields like space research, movements in the interior of the earth, research in oil deposits, medicine, meteorology, engineering, military etc. C-DAC has also participated in developing the ISCII code for writing different language scripts. (Indian Script Code for Information Interchange)

Exercises



1. Fill in the blanks to complete the statements. Justify the statements.

- While working with a computer we can read the information stored in its memory and perform other actions in memory.
- While presenting pictures and videos about the works of scientists, we can use
- To draw graphs based on the quantitative information obtained in an experiment, one uses
- The first generation computers used to shut down because of
- A computer will not work unless is supplied to it.

2. Answer the following questions.

- Explain the role and importance of information communication in science and technology.
- Which application software in the computer system did you find useful while studying science, and how?
- How does a computer work?
- What precautions should be taken while using various types of software on the computer?
- Which are the various devices used in information communication? How are they used in the context of science?

3. Using a spreadsheet, draw graphs between distance and time, using the information about the movements of Amar, Akbar and Anthony given in the table on page 4, in the lesson on Laws of Motion. What precautions will you take while drawing the graph?

4. Explain the differences between the different generations of computers. How did science contribute to these developments?

5. What devices will you use to share with others the knowledge that you have?

6. Using information communication technology, prepare powerpoint presentations on at least three topics in your textbook.

Make a flowchart of the steps you used while making these presentations.

7. Which technical difficulties did you face while using the computer? What did you do to overcome them?

Project :

Taking help from your teachers, make a documentary about ISRO the institute mentioned in Chapter 18, using information communication devices.



11. Reflection of Light



➤ Mirrors and types of mirrors ➤ Spherical mirrors and images formed by them ➤ Magnification due to spherical mirrors



Can you recall?

1. What is light?
2. What is meant by reflection of light? Which are the different types of reflection?

Light is an agent which gives us information about what is happening in our surroundings. We can enjoy various wonders of nature like the sunrise, sunset and rainbow only because there is light. It is only because of light that we can see the lush green vegetation, colourful flowers, deep blue skies in the day, stars shining in the dark night sky in the beautiful world around us. We can see the man-made objects in our surroundings as well. Light is actually electromagnetic radiation which causes the sensation of vision.

Light reflects differently from the various surfaces around us. We have already learnt that the reflection from smooth, flat surfaces is regular reflection while rough surfaces reflect light irregularly.

Mirror and types of mirrors



Can you tell?

What is a mirror?

We need polished surfaces for reflecting light. This is because polished surfaces absorb less light and so maximum light gets reflected.

In scientific language, a surface which reflects light and creates clear images is called a mirror. A mirror is a reflecting surface.

We use various types of mirrors in our daily life. Mirrors are of two types: plane mirrors and spherical mirrors.

Plane mirror – Plane mirrors are used in various activities in our day to day life. A mirror is made by coating the back surface of a flat and smooth glass piece with a thin, reflecting film of aluminium or silver. To protect this reflecting film and to make that side opaque, another coat of a substance like lead oxide is given over it.



Can you recall?

What are the laws of reflection of light?

10.1 Plane mirror

An introduction to scientists

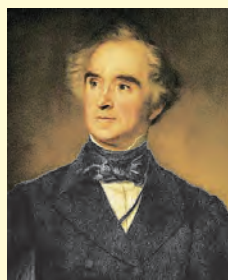

The German scientist Justus von Liebig coated the plane surface of a piece of ordinary glass with silver metal and made the first mirror. Such a mirror is called a silvered glass mirror.



We see a clear image of ourselves when we stand in front of a mirror in our house. To understand how an image is formed in a mirror let us first consider an image formed by a point source. Light rays travel in all directions from such a source. Several of these rays fall on the mirror, get reflected and reach our eyes. Due to reflection, they appear to be coming from a point behind the mirror. That point is the image of the point source.

As figure 11.2 A shows, light rays falling perpendicularly on the mirror are reflected back in the perpendicular direction.

Figure 11.2 B shows a point source O in front of the plane mirror M_1M_2 . Incident rays OR_1 and OR_2 get reflected according to the laws of reflection along paths R_1S_1 and R_2S_2 respectively. When these reflected rays are extended behind the mirror, they meet at O_1 . When seen from E , the rays appear to be coming from O_1 . Other rays starting from O also get reflected and appear to be coming from O_1 . Thus, point O_1 is the image of point O .

The reflected rays do not actually meet. Hence, such an image is called a virtual image. The perpendicular distance of the image from the mirror is equal to the perpendicular distance of the source from the mirror.

If we use an extended source instead of a point source, an image is formed of every point of the source, thereby forming an extended image of the whole source. As shown in figure 11.2 C, an extended source PQ is kept in front of the mirror M_1M_2 . The images of P and Q are formed at P_1 and Q_1 respectively. Similarly, images of all points between P and Q are formed between P_1 and Q_1 resulting in the image P_1Q_1 of the entire extended source.

The image formed by a plane mirror is of the same size as the source.

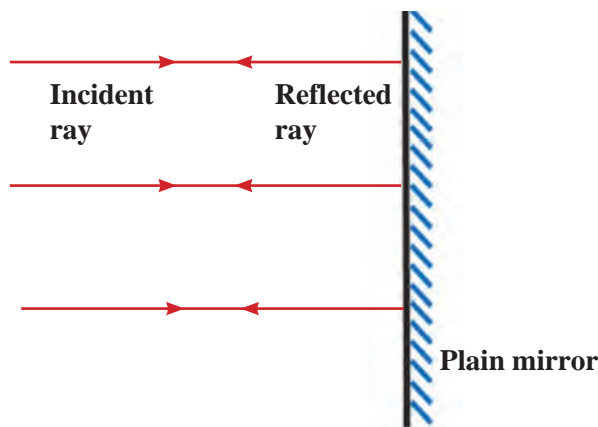

A. Rays falling on a mirror normal to its surface

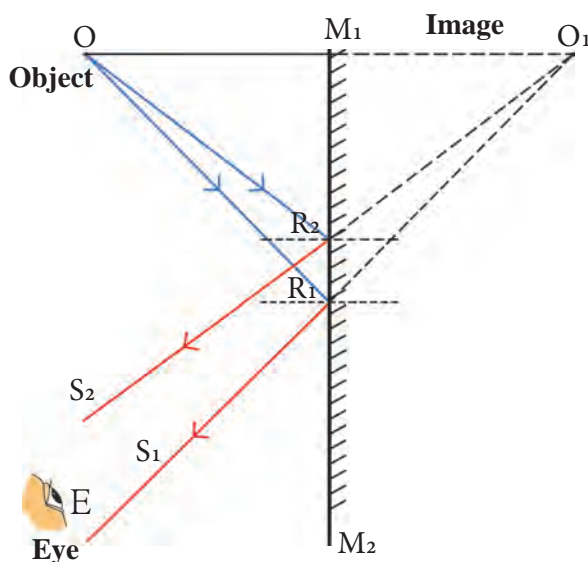

B. Image of a point source formed by a mirror

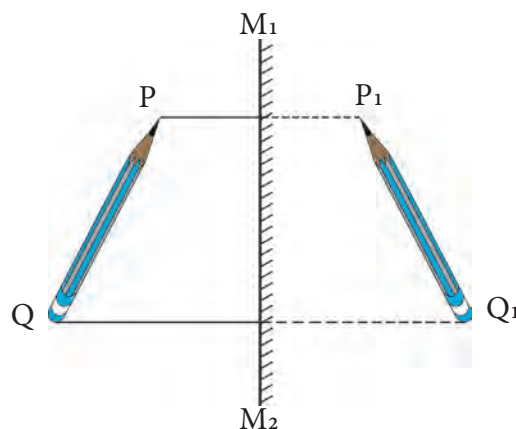

C. Image of an extended source formed by a mirror

11.2 Formation of images by a mirror

1. If we hold a page of a book in front of a mirror, we see laterally inverted letters in the mirror. Why does it happen?
2. Which letters of the English alphabet form images that look the same as the original letters?



Can you tell?

The image of a word appears laterally inverted in the mirror. The image of every point on the word is formed behind the mirror at the same distance from the mirror as the point itself. This is called lateral inversion.



Use your brain power !

When a person stands in front a plane mirror, how is the image formed? What is the nature of the image?



Try this

Place two plane mirrors at an angle of 90° to each other. Place a small object between them. Images will be formed in both mirrors. How many images do you see?

Now change the angle between the mirrors as given in the following table and count the number of images each time. How is this number related to the measure of the angle? Discuss this relationship.

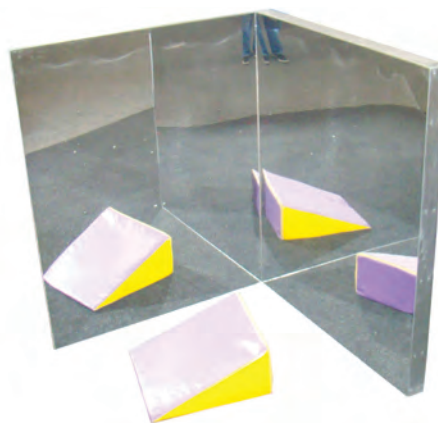

11.3 Mirrors at right angles to each other

Angle	Number of images
120°	
90°	
60°	
45°	
30°	

$$n = \frac{360^\circ}{A} - 1$$

n = number of images, A = angle between the mirrors

1. Check if the number of images that you obtained for different values of angles is consistent with the above formula.
2. If we keep the mirrors parallel to each other, how many images will we see?

Statement: In order to see the full image of a person standing in front of a mirror, the minimum height of the mirror must be half the height of the person.

Proof : In figure 11.4, the point at the top of the head, the eyes and a point at the feet of a person are indicated by H, E and F respectively. R and S are midpoints of HE and EF respectively. The mirror PQ is at a height of NQ from the ground and is perpendicular to it. PQ is the minimum height of the mirror in order to obtain the full image of the person. For this, RP and SQ must be perpendicular to the mirror. Find out why, by studying the figure 11.4.

Minimum height of the mirror

$$PQ = RS$$

$$= RE + ES = \frac{HE}{2} + \frac{EF}{2} = \frac{HF}{2} = \text{Half of the person's height}$$

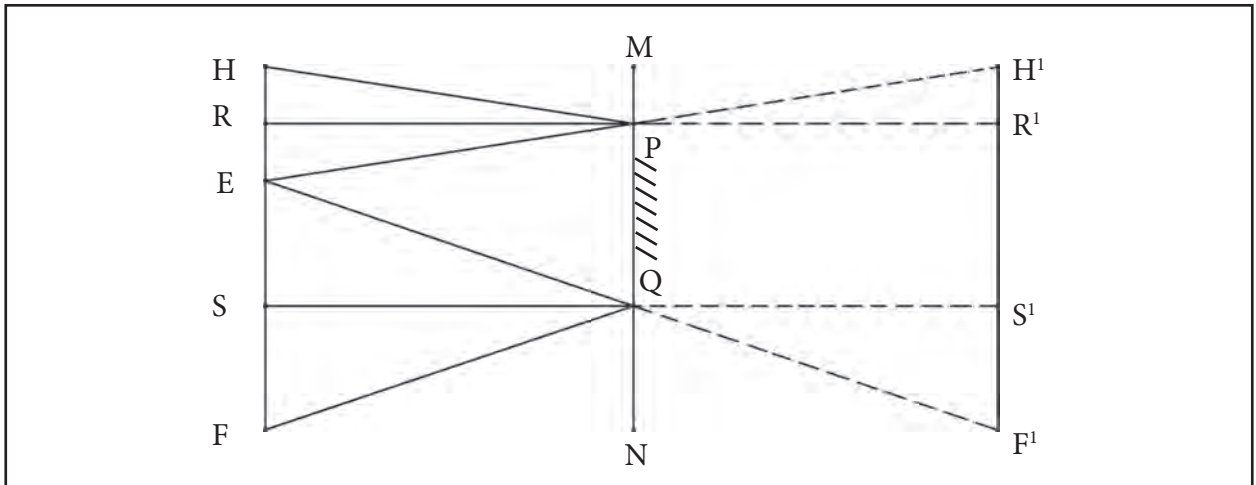

11.4 A plane mirror and the full image of a person

Spherical mirrors



Observe and discuss.



11.5 Laughing Chamber

You must have seen the mirrors displayed in the Laughing Chamber in a fair. Your face appears distorted in these mirrors. Why does this happen? These mirrors are different from the mirrors we have at home. They are curved. The images formed by curved mirrors are different from those formed by plane mirrors. Because of this we do not see the familiar images in these mirrors.

The rear view mirrors in cars, which enable drivers to see the vehicles coming from behind, are curved mirrors.



Try this

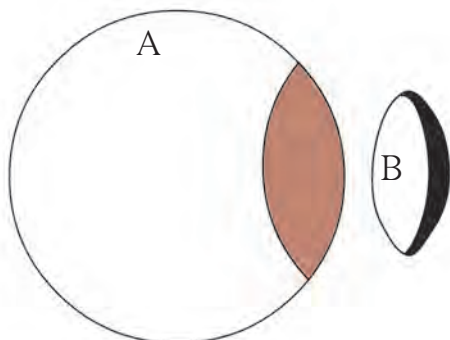

11.6 Creation of spherical mirrors

If we cut a rubber ball into two parts as shown in figure 11.6, we can see that each of the two parts has two types of surfaces.

Generally, spherical mirrors are parts of a hollow glass sphere like the part B in the figure. The inner or outer surface of this part is coated with a shiny substance to produce a spherical mirror. Reflection of light takes place either from its outer or inner surface. Thus, there are two types of spherical mirrors as described below.

A. Concave mirror

If the inner surface of the spherical mirror is the reflecting surface, then it is called a concave mirror.

B. Convex mirror

If the outer surface of the spherical mirror is the reflecting surface then it is called a convex mirror.

Terms related to spherical mirrors

Pole : The centre of the mirror surface is called its pole. P is the pole of the mirror in figure 11.7.

Centre of curvature : The centre of the sphere of which the mirror is a part, is called the centre of curvature of the mirror. C is the centre of curvature of the mirror in the figure.

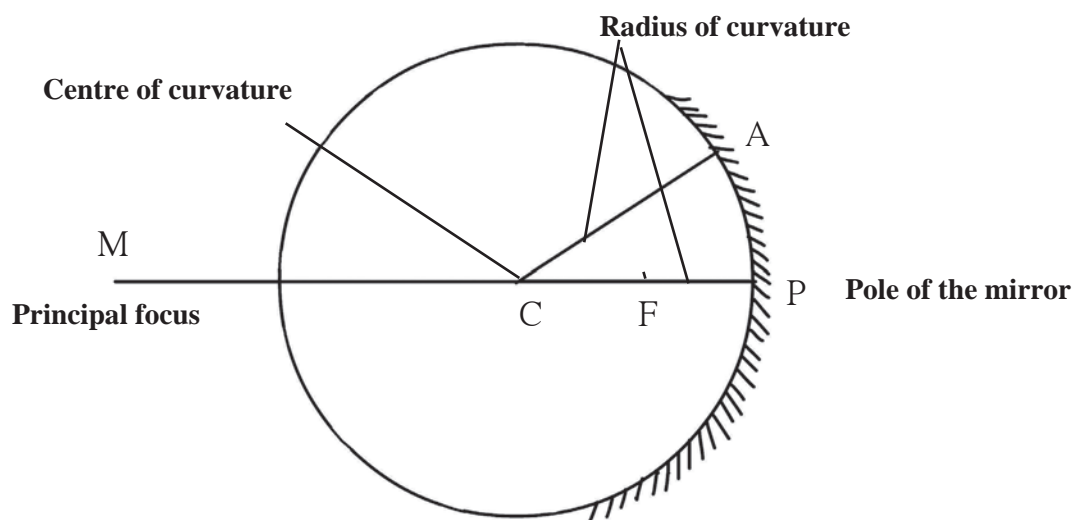

11.7 Terms related to spherical mirrors

Radius of curvature : The radius of the sphere of which the mirror is a part, is called the radius of curvature of the mirror. The length CP or CA in the figure is the radius of curvature of the mirror.

Principal axis : The straight line passing through the pole and centre of curvature of the mirror is called its principal axis. PM is the principal axis of the mirror in the figure.

Principal focus : Incident rays which are parallel to the principal axis of a concave mirror, after reflection from the mirror, meet at a particular point in front of the mirror on the principal axis. This point (F) is called the principal focus of the concave mirror. In the case of a convex mirror, incident rays parallel to the principal axis, after reflection, appear to come from a particular point behind the mirror lying along the principal axis. This point is called the principal focus of the convex mirror.

Focal length : The distance (f) between the pole and the principal focus of the mirror is called the focal length. This distance is half of the radius of curvature of the mirror.



Use your brain power !

What is the difference between the principal focus of the concave and convex mirrors?

Drawing the reflected rays



Try this

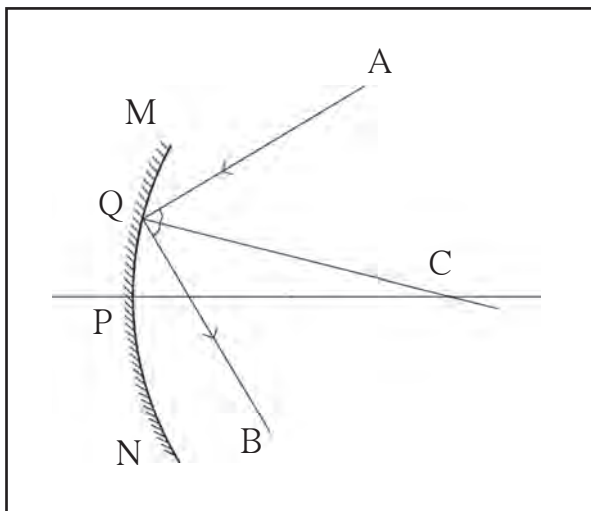

11.8 Drawing the reflected rays.

How do we determine the direction that an incident ray will take after reflection from a spherical mirror? In figure 11.8, MN is a spherical mirror and ray AQ is incident on it. CQ is a radius and therefore is perpendicular to the mirror at Q. Thus, angle AQC is the angle of incidence. According to the laws of reflection, angle of incidence and angle of reflection are of the same measure. Thus, while drawing the reflected ray QB, angle CQB must be equal to the angle AQC.

We can study the images produced by spherical mirrors by drawing ray diagrams. A ray diagram is the depiction of the path taken by light rays. To draw a ray diagram, we use the following rules, which are based on the laws of reflection of light. (See figure 11.9).

Rule 1 : If an incident ray is parallel to the principal axis then the reflected ray passes through the principal focus.

Rule 2 : If an incident ray passes through the principal focus of the mirror, the reflected ray is parallel to the principal axis.

Rule 3 : If an incident ray passes through the centre of curvature of the mirror, the reflected ray traces the same path back.

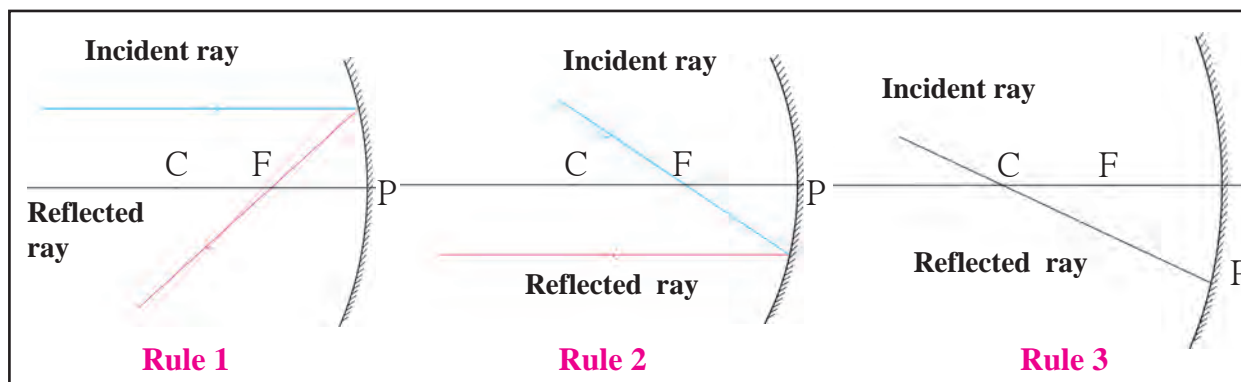

11.9 Rules for drawing ray diagrams

Images formed by a concave mirror



Try this

Material : Candle or glass lamp, two cardboard boxes, large cardboard sheet, white paper, concave mirror, metre ruler, wooden block.

Action : Take the cardboard box, large enough to hold the candle or lamp. Cut off one side and place the candle inside. Cut out an arrow shaped slit from one side, so that we get an arrow shaped light source. Make a screen of size 20 cm x30 cm by sticking a white paper on the cardboard sheet and set it up vertically with the help of the wooden block. Fix the mirror vertically on the other cardboard box by making a slit on its top surface.

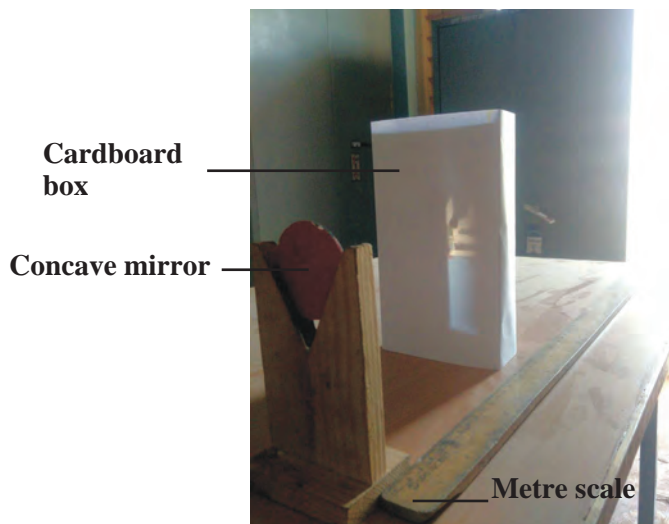

11.10 Images formed by a plane mirror

Place the screen near a window and place the mirror in front of it such that the image of the sun or some far away object forms clearly on the screen. Measure the distance between the screen and the mirror in this situation. This is the focal length of the mirror.

Set up the experiment as shown in figure 11.10, in a dark room. Place the mirror near the 0 mark on the metre scale. Place the screen in front of it and place the light source in between the two so that the distance between the mirror and the source is a little more than the focal length of the mirror.

Obtain a clear image of the source on the screen by moving the screen along the metre scale and perpendicular to it. The image will be inverted and larger than the source. As the image is obtained on the screen, it is a real image.

Now move the source away from the mirror so that the distance between the two is greater than twice the focal length of the mirror. Get a clear image on the screen by moving it towards the mirror. The image is inverted, smaller than the object and real.



Observe

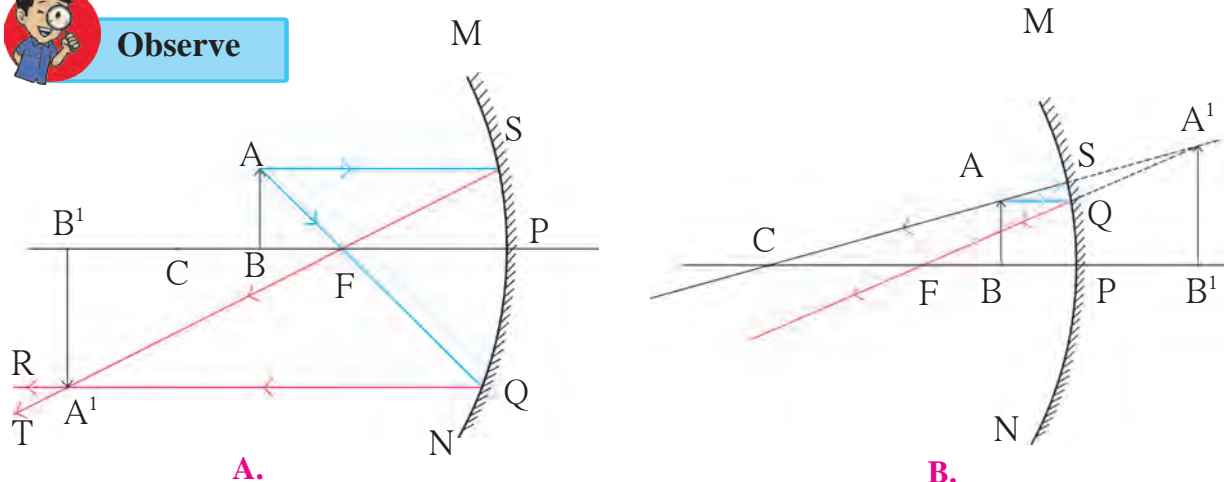

11.11 Images obtained in a concave mirror

As shown in figure 11.11 A, an object AB is placed between the focus and the centre of curvature of the concave mirror MN. The incident ray AQ, starting from A, and going through the focus F, becomes parallel to the principal axis after reflection and returns along QR. The incident ray AS, parallel to the axis, after reflection passes through the focus and returns along the path ST. It cuts the reflected ray QR at point A¹. Thus, the image of A is formed at A¹. The point B is situated on the principal axis and so its image will also be on the axis and will be directly above A¹. Thus the image of B is at B¹. The images of points between A¹ and B¹ will be formed between points A¹ and B¹. Thus, the image of object AB is A¹B¹.

From this we see that when the object is placed between the focus and the centre of curvature of the mirror, the image is formed beyond the centre of curvature. This image is larger than the object and is inverted. As the reflected rays actually cross each other, the image is a real image and can be obtained on a screen.

In figure 11.11 B, an object AB is placed between the pole and focus of the mirror. The incident ray AQ is parallel to the principal axis and the incident ray AS is in the direction joining A with the centre of curvature. The figure shows how these rays get reflected and form the image A¹B¹ of the object. This image is behind the mirror, erect and larger than the object. As the reflected rays do not actually meet but appear to come together behind the mirror, the image is a virtual image.

The position and type of the image produced by a concave mirror when an object is placed at different distances from it are given in the following table.

Images formed by concave mirrors

No.	Position of the object	Position of the image	Nature of image	Size of the image
1	Between pole and focus	Behind the mirror	Erect, virtual	Magnified
2	At the focus	At infinity	Inverted, real	Very large
3	Between focus and centre of curvature	Beyond the centre of curvature	Inverted, real	Magnified
4	At the centre of curvature	At the centre of curvature	Inverted, real	Same as the object
5	Beyond the centre of curvature	Between the centre of curvature and focus	Inverted, real	Diminished
6	At a very large (infinite) distance	At focus	Inverted, real	Point image



Draw ray diagrams and determine the position and type of images formed by a concave mirror when the object is placed at (1) Focus (2) Centre of curvature (3) Beyond the centre of curvature and (4) At an infinite distance. Tally your answers with the information given in the table.

Image formed by a convex mirror

Figure 11.12 shows an object AB kept in front of a convex mirror MN. Incident rays AQ, starting from A and travelling parallel to the axis and AR going towards the centre of curvature are shown. How these get reflected and form the image A'B' can be understood from the figure. It is clear that the image is smaller than the object, behind the mirror and erect. As the reflected rays do not actually cross one another, the image is a virtual image.

The nature of the image formed by a convex mirror does not depend on the distance of the object from the mirror. These images are always virtual, smaller than the object and situated behind the mirror.

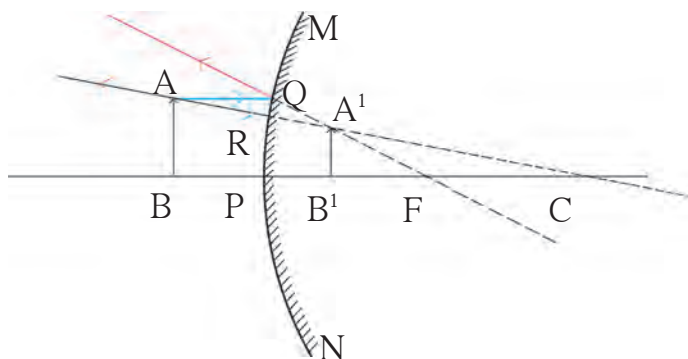

11.12 Image formed in a convex mirror

Divergence and convergence of light

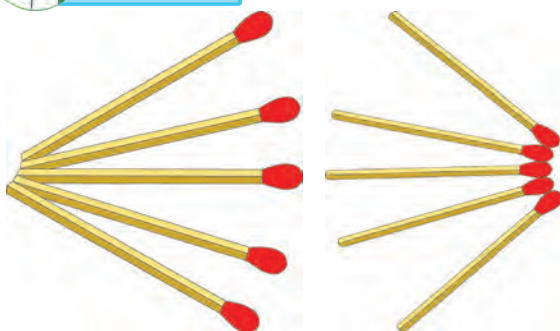

11.13 Divergence and convergence

- Take 5 sticks from a matchbox. Arrange them so that their heads come together at a point. In this arrangement, the heads of the matchsticks are said to have converged.
- Now arrange the sticks so that their uncoated ends are together at a point. The heads are spread apart. In this arrangement, the heads are diverging from the point.

A concave mirror is also called a focusing mirror. This is because, as shown in figure 11.14 A, parallel rays get focused after reflection in this mirror. The size of the image produced by these mirrors can be larger or smaller than the object, depending upon the distance of the object from the mirror.

A convex mirror is also called a dispersing mirror. This is because, as shown in figure 11.14 B, parallel incident rays get dispersed after reflection in this mirror. The size of the images produced by these mirrors is always smaller than the size of the objects.

How will you find out if a mirror is concave or convex?

The special mirror which is used for shaving is a concave mirror. When held close to the face, it gives vertical and larger image of the face. If the same mirror is taken farther away from the face, the image gets smaller and smaller.

The mirrors used in cars and motorcycles are convex mirrors. In these mirrors the image of a face is erect and smaller and it remains erect but becomes smaller and smaller when the mirror is taken away from the face. As a result we can see the images of the surroundings also in the mirror. Thus, we can determine the nature of the mirror by studying the images produced by them.

When the light rays coming from an object enter our eyes, we can see the object because, while passing through the lenses in our eyes, the rays converge, and the image of the object forms on the retina of our eye. This image, formed by the light rays actually converging at a point, is a real image. A real image can be obtained on a screen.

The image produced by a plane mirror is a virtual image. This image is produced at a point from which the reflected light rays appear to diverge (figure 11.2 B). This image cannot be obtained on a screen as the rays do not actually meet there.

When light rays collect at a point after reflection from a spherical mirror, they are said to converge there. When we want to bring light rays together at a point, a converging light beam is used. Doctors use such a beam to converge light on a tooth, ear, nose, etc. Equipment using solar energy also use converging light.

When light rays starting from a point spread out after reflection by a spherical mirror, light is said to have diverged. When we want light rays to spread out from a source, a divergent beam is used, as for example, in street lamps.

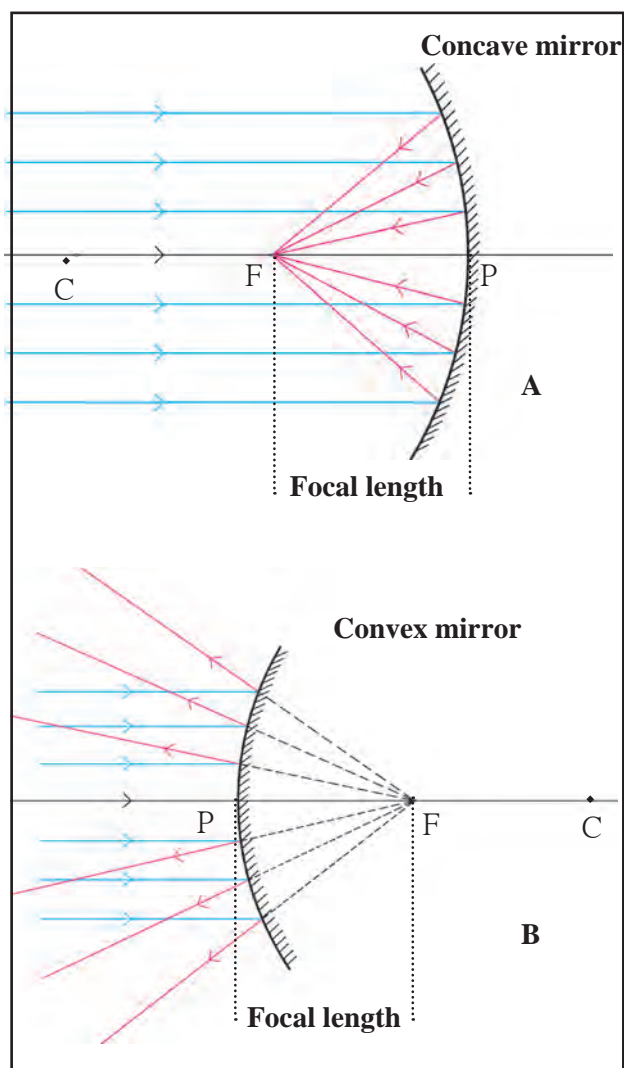

11.14 Concave and convex mirror

Uses of concave mirrors

1. Barber shop, dental hospital – If the object is placed between the pole and focus of the mirror, an erect, virtual and magnified image is obtained
2. Torch and head lamps of vehicles- The source of light is kept at the focus of the mirror. Thus, a parallel beam of light is obtained.
3. Flood lights- The source of light is placed a little beyond the centre of curvature of the mirror. This gives a bright beam of light.
4. Various equipment using solar energy - Sun rays reflected by a concave mirror come together in the focal plane.

Uses of convex mirrors

1. Mirrors on the sides of cars are convex mirrors
2. Big convex mirrors are fitted at gate and in square.

According to the Cartesian sign convention, the pole of the mirror is taken as the origin. The principal axis is taken as the X- axis of the frame of reference. The sign conventions are as follows.

1. The object is always kept on the left of the mirror. All distances parallel to the principal axis are measured from the pole of the mirror.
2. All distances measured towards the right of the pole are taken to be positive, while those measured towards the left are taken to be negative.
3. Distances measured vertically upwards from the principal axis are taken to be positive.
4. Distances measured vertically downwards from the principal axis are taken to be negative.
5. The focal length of a concave mirror is negative while that of a convex mirror is positive.

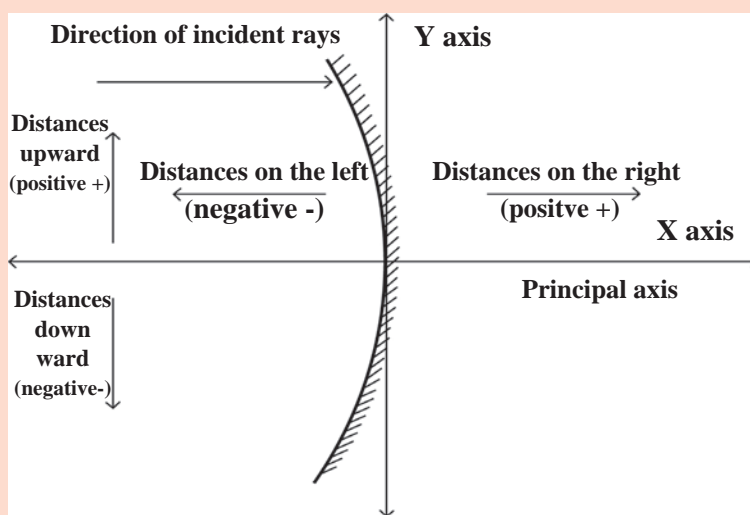

11.15 Cartesian sign conventions

Mirror formula

We get the correct values of distances by using the Cartesian sign convention. The object distance (u) is the distance of the object from the pole, while the image distance (v) is the distance of the image from the pole. The relationship between the object distance, image distance and the focal length (f) is called the mirror formula.

Mirror formula

$$\frac{1}{v} + \frac{1}{u} = \frac{1}{f}$$

This formula is valid for all spherical mirrors, for all positions of objects, under all circumstances.

Magnification due to spherical mirrors

The magnification due to a spherical mirror is given by the ratio of the height of the image (h_2) to the height of the object (h_1). This tells us how large the image is as compared to the object.

$$\text{Magnification } M = \frac{\text{Height of the image}}{\text{Height of the object}} = \frac{h_2}{h_1}. \text{ From this it can be shown that } M = -\frac{v}{u}$$

As the object is always kept above the principal axis, its height is always taken to be positive. For virtual images, the height is positive while for real images, it is negative. As the object is kept on the left of the mirror, its distance (u) is always negative.



Try this

Determine the sign of magnification in each of the 6 cases in the table on page 122 using both formulae and verify that they are the same.

Solved examples

Example : Rajashree wants to get an inverted image of height 5 cm of an object kept at a distance of 30 cm from a concave mirror. The focal length of the mirror is 10 cm. At what distance from the mirror should she place the screen ? What will be the type of the image, and what is the height of the object?

Given :

Focal length = $f = -10$ cm, object distance = $u = -30$ cm,

height of the image = $h_2 = -5$ cm

Image distance = $v = ?$, height of object = $h_1 = ?$

According to the mirror formula

$$\frac{1}{v} + \frac{1}{u} = \frac{1}{f}$$

$$\frac{1}{v} = \frac{1}{f} - \frac{1}{u}$$

$$\frac{1}{v} = \frac{1}{-10} - \frac{1}{-30}$$

$$\frac{1}{v} = \frac{-3 + 1}{30}$$

$$\frac{1}{v} = \frac{-2}{30}$$

$$\frac{1}{v} = \frac{1}{-15} \text{ cm}$$

$$v = -15$$

Rajashree has to place the screen 15 cm to the left of the mirror.



Magnification

$$M = \frac{h_2}{h_1} = -\frac{v}{u}$$

$$h_1 = -\frac{uh_2}{v}$$

$$h_1 = -\frac{(-30)(-5)}{-15}$$

$$h_1 = (-2)(-5)$$

$$h_1 = 10 \text{ cm}$$

The height of the object is 10 cm. Thus, the image will be real and diminished.



Always remember

The image in front of the mirror which can be obtained on a screen is called a real image. For any position of the object, a convex mirror always produces an erect diminished image (which is smaller than the object) and is situated behind the mirror. The image which is behind the mirror and thus cannot be obtained on a screen is called a virtual image. The magnification of such an image is less than 1.

Exercises



1. Answer the following questions.

- Explain the difference between a plane mirror, a concave mirror and a convex mirror with respect to the type and size of the images produced.
- Describe the positions of the source of light with respect to a concave mirror in
 - Torch light
 - Projector lamp
 - Floodlight
- Why are concave mirrors used in solar devices?
- Why are the mirrors fitted on the outside of cars convex?
- Why does obtaining the image of the sun on a paper with the help of a concave mirror burn the paper?
- If a spherical mirror breaks, what type of mirrors are the individual pieces?

2. What sign conventions are used for reflection from a spherical mirror?

3. Draw ray diagrams for the cases of images obtained in concave mirrors as described in the table on page 122.

4. Which type of mirrors are used in the following?

Periscope, floodlights, shaving mirror, kaleidoscope, street lights, head lamps of a car.

5. Solve the following examples

- An object of height 7 cm is kept at a distance of 25 cm in front of a concave mirror. The focal length of

the mirror is 15 cm. At what distance from the mirror should a screen be kept so as to get a clear image? What will be the size and nature of the image? **(Answer: 37.5 cm and**

10.5 cm. Image is real)

- A convex mirror has a focal length of 18 cm. The image of an object kept in front of the mirror is half the height of the object. What is the distance of the object from the mirror?

(Answer: 18 cm)

- A 10 cm long stick is kept in front of a concave mirror having focal length of 10 cm in such a way that the end of the stick closest to the pole is at a distance of 20 cm. What will be the length of the image?

(Answer: 10 cm)

- Three mirrors are created from a single sphere. Which of the following - pole, centre of curvature, radius of curvature, principal axis - will be common to them and which will not be common?



Project :

Make a kaleidoscope and make a presentation in the class about how it works.



12. Study of Sound



- Sound waves
- Velocity of sound
- Reflection of sound
- The human ear, audible sound, infra sound and ultrasound



Can you recall?

1. How does the velocity of sound depend on its frequency?
2. How is the direction of the oscillation of the particles of the medium related to the direction of propagation of the sound-wave?

Sound is a form of energy which creates the sensation of hearing in our ears. This energy is in the form of waves. A medium is necessary for the propagation of sound waves. Sound waves give rise to a chain of compression (place of higher density) and rarefaction (place of lower density) in the medium. The particles of the medium oscillate about their central or mean positions, in a direction parallel to the propagation of the wave. Such waves are called **longitudinal waves**. On the other hand, in the waves created by dropping a stone in still water, the particles of water oscillate up and down. These oscillations are perpendicular to the direction of propagation of the wave, such waves are called **transverse waves**.



Observe and discuss.

A sound wave can be shown in the form a graph. At any moment during the propagation of a sound wave we would find alternate bands of compression and rarefaction of the medium i.e. bands of greater and lesser density.

Figure 12.1 A shows the changes in density while figure B shows the changes in pressure. The changes in density or pressure are shown in the form of a graph in figure C.

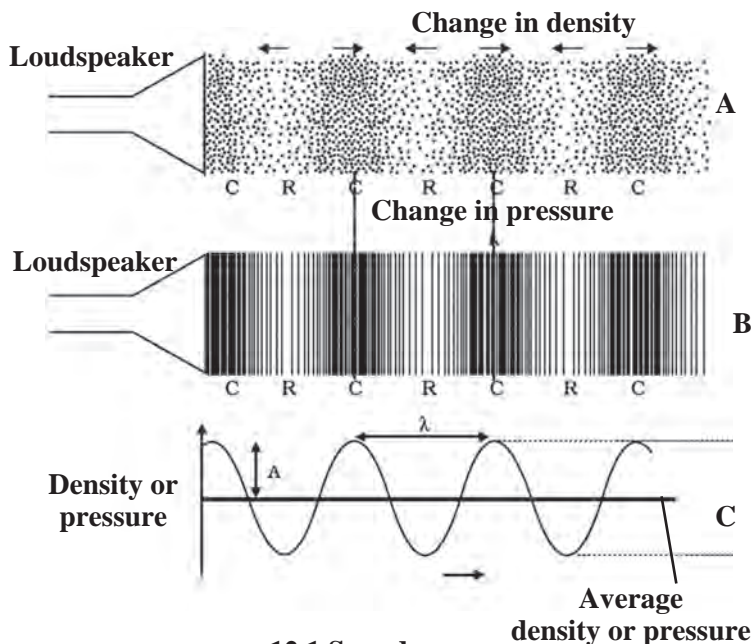

12.1 Sound waves

The wavelength of sound waves is indicated by the Greek letter *lambda* (λ), while its frequency is indicated by *nu* (ν). The amplitude, which is the maximum value of pressure or density, is indicated by A. The time taken for one oscillation of pressure or density at a point in the medium is called the time period and is indicated by T.

The value of frequency determines the pitch (high or low) of the sound while the value of the amplitude determines its strength or loudness.



Research

1. How are the frequencies of notes *sa, re ga ma, pa, dha, ni* related to each other?
2. What is the main difference between the frequencies of the voice of a man and that of a woman?

Velocity of sound



Try this

1. Take your friend to a place where there are iron pipes e.g. the school verandah, a staircase or a fence.
2. Stand near one end of the pipe and ask the friend to stand 20 to 25 feet away from you near the pipe.
3. Ask the friend to gently tap the pipe with a stone. Press your ear to the pipe and listen to the sound coming through the pipe.
4. The same sound coming through the air can also be heard. But which sound reaches you first?

From the above activity you can see that you hear the sound through the iron pipe much before you hear it coming through air. This shows that sound travels faster in iron than in air.

The distance covered by a point on the wave (for example the point of highest density or lowest density) in unit time is the velocity of the sound wave.

$$\text{Velocity} = \frac{\text{Distance}}{\text{Time}}$$

Any point on the sound wave covers a distance equal to λ (wavelength) in time T (time period). Thus the velocity of sound is given by

$$v = \nu \lambda \text{ because } \frac{1}{T} = \nu$$

$$\text{Velocity} = \frac{\text{Wavelength}}{\text{Time period}} \quad v = \frac{\lambda}{T}$$

Thus, the velocity of sound = wavelength x frequency.

In any medium at fixed physical conditions the velocity of sound of different frequencies is very nearly the same. The velocity is highest in solids and least in gases. It increases with an increase in the temperature of the medium.

The Italian physicists Borelli and Viviani, in the 1660s, first calculated the speed of sound. They measured the time between seeing the flash of a gun and hearing its sound from a long distance. Their value of 350 m/s is very close to the value of 346 m/s which is accepted today.

Velocity of sound in various mediums at 25°C

State	Substance	Speed (m/s)
Solid	Aluminum	5420
	Nickel	6040
	Steel	5960
	Iron	5950
	Brass	4700
	Glass	3980
Liquid	Sea water	1531
	Pure water	1498
	Ethanol	1207
	Methanol	1103
Gas	Hydrogen	1284
	Helium	965
	Air	346
	Oxygen	316
	Sulphur dioxide	213

Velocity of sound in a gaseous medium: The velocity of sound in a gaseous medium depends on the physical conditions i.e. the temperature, density of the gas and its molecular weight.

Temperature (T): The velocity of sound is directly proportional to the square root of the temperature of the medium. This means that increasing the temperature four times doubles the velocity.

$$v \propto \sqrt{T}$$

Density (ρ): The velocity of sound is inversely proportional to the square root of density. Thus, increasing the density four times, reduces the velocity to half its value.

$$v \propto \frac{1}{\sqrt{\rho}}$$

Molecular weight (M): The velocity sound is inversely proportional to the square root of molecular weight of the gas. Thus, increasing the molecular weight four times, reduces the velocity to half its value.

$$v \propto \frac{1}{\sqrt{M}}$$

Think

The molecular weight of oxygen gas (O_2) is 32 while that of hydrogen gas (H_2) is 2. Prove that under the same physical conditions, the velocity of sound in hydrogen is four times that in oxygen.

For a fixed temperature, the velocity of sound does not depend on the pressure of the gas.

Audible, infra- and ultra-sound

The limits of hearing of the human ear are 20 Hz to 20,000 Hz. That is, the human ear can hear sounds of frequencies in this range. These sounds are called audible sounds. Our ears cannot hear sounds of frequencies lower than 20 Hz and higher than 20,000 Hz (20 kHz). Sound with frequency smaller than 20 Hz is called infra sound. The sound produced by a pendulum and the sound generated by the vibrations of the earth's crust just before an earthquake are examples of such sounds. Sound waves with frequency greater than 20 kHz are called ultrasound.

The dog, mouse, bat, dolphin etc have a special ability to hear infra sounds. Thus, they can sense some noise which are inaudible to us. Children under 5 years of age and some creatures and insects can hear waves with frequency up to 25 kHz. Bats, mice, dolphins, etc, can also produce ultrasound.

A peep into the past

The Italian scientist Spallanzani was the first to discover a special mechanism present in bats. He covered various organs of bats like the eyes, ears, nose, etc. one by one and allowed them to fly in the dark thereby discovering how they can fly easily in the dark. He found that the bats with their ears covered began to collide with whatever came in their path. Even though their eyes were open. They were of no use to the bats. He thus discovered that their ability to fly in the dark depends on their ears and not eyes.

The ultrasonic sound produced by bats, gets reflected on hitting an obstacle. This reflected sound is received by their ears and they can locate the obstacle and estimate its distance even in the dark.

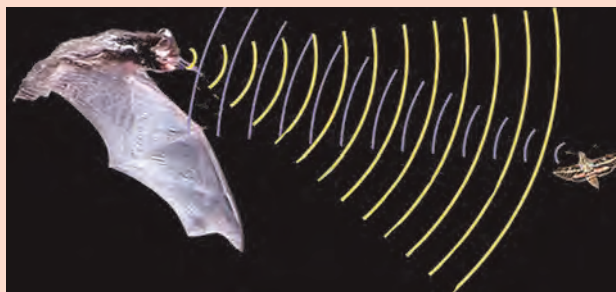

Uses of ultrasonic sound

1. For communication between ships at sea.
2. To join plastic surfaces together.
3. To sterilize liquids like milk by killing the bacteria in it so that the milk keeps for a longer duration.
4. Echocardiography which studies heartbeats, is based on ultrasonic waves (Sonography technology).
5. To obtain images of internal organs in a human body.
6. In industry, to clean intricate parts of machines where hands cannot reach.
7. To locate the cracks and faults in metals blocks.

Reflection of sound



Try this

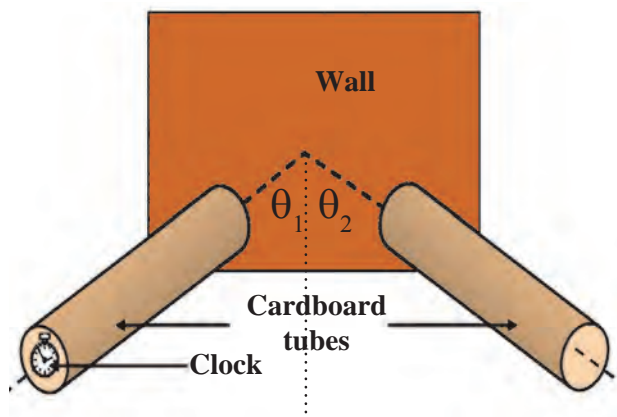

12.2 Reflection of sound

1. Make two sufficiently long, identical tubes out of a cardboard.
2. Arrange them on a table, in front of a wall as shown in figure 12.2.
3. Place a clock near the end of one of the tubes and try to hear the ticking of the clock at the end of the other tube by placing your ear there.
4. Adjust the angles of the two tubes till you can hear the sound very clearly.
5. Measure the angle of incidence θ_1 and the angle of reflection θ_2 . Try to see if they are related in any way.

Like light waves, sound waves, too, get reflected from a solid or a liquid surface. These waves also follow the laws of reflection. A smooth or a rough surface is needed for the reflection of sound. The direction of the incident sound wave and reflected sound wave make equal angles with the perpendicular to the surface and all these three lie in the same plane.

Good and bad reflectors of sound

How much of the incident sound gets reflected decides whether a reflector is a good or a bad reflector. A hard and flat surface is a good reflector while clothes, paper, curtains, carpet, furniture, etc. absorb sound instead of reflecting it and, therefore are called bad reflectors.



Use your brain power !

In the activity on page no. 131, what will happen if you lift one of the tubes to some height?

Echo

You must have visited an echo point at a hill station. If you shout loudly at such a point, you hear the same sound just after a little while. This sound is called an echo.

An echo is the repetition of the original sound because of reflection by some surface.

In order to be able to hear the original sound and its reflection distinctly, at 22 °C, what must the minimum distance be between the source and the reflecting surface? At 22 °C, the velocity of sound in air is 344 m/s. Our brain retains a sound for 0.1 s. Thus, for us to be able to hear a distinct echo, the sound should take more than 0.1 s after starting from the source to get reflected and come back to us. Thus we can determine the minimum distance between the source and the reflecting surface as follows:

$$\begin{aligned} \text{Distance} &= \text{speed} \times \text{time} \\ &= 344 \text{ m/s} \times 0.1 \text{ s} \\ &= 34.4 \text{ m} \end{aligned}$$

Thus, to be able to hear a distinct echo, the reflecting surface should be at a minimum distance of half of the above i.e. 17.2 m. As the velocity of sound depends on the temperature of air, this distance depends on the temperature.

Reverberation

Compare the two cases:

- | | |
|--|--|
| <ol style="list-style-type: none"> 1. Go to an empty, closed house with your friends. 2. Once inside, chat with your friends. 3. Note what you sense. | <ol style="list-style-type: none"> 1. Close the doors and windows of your house and switch on the music system. 2. Increase the loudness of the system as much as possible. 3. Note what you sense. |
|--|--|



Use your brain power !

1. To hear the echo distinctly, will the distance from the source of sound to the reflecting surface be same at all temperatures? Explain your answer.
2. When is the reflection of sound harmful?

Science in the surroundings.....

Echo can be heard multiple times due to continuous or multiple reflections. The golghumat at Vijapur in Karnataka is an excellent example of this.



Sound waves get reflected from the walls and roof of a room multiple times. This causes a single sound to be heard not once but continuously. This is called reverberation. The time between successive reflections of a particular soundwave reaching us becomes smaller and the reflected sounds get mixed up and produce a continuous sound of increased loudness which cannot be deciphered clearly. This is the reason why some auditoriums or some particular seats in an auditorium have inferior sound reception. This is shown in figure 12.3.

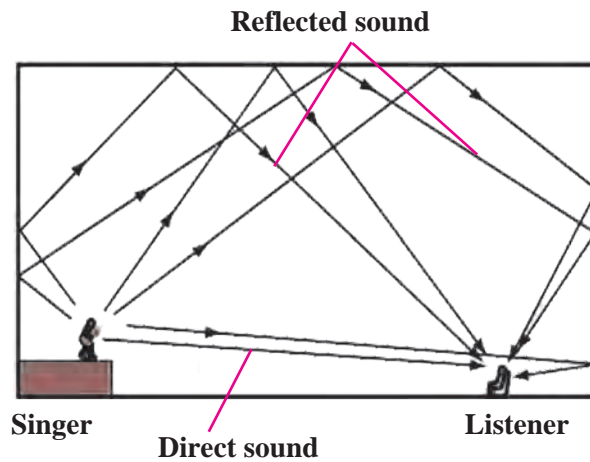

12.3 Reverberation



Use your brain power !

How will you reduce reverberation in public halls or buildings?

SONAR

SONAR is the short form for Sound Navigation and Ranging. It is used to determine the direction, distance and speed of an underwater object with the help of ultrasonic sound waves. SONAR has a transmitter and a receiver, which are fitted on ships or boats.

The transmitter produces and transmits ultrasonic sound waves. These waves travel through water, strike underwater objects and get reflected by them. The reflected waves are received by the receiver on the ship.

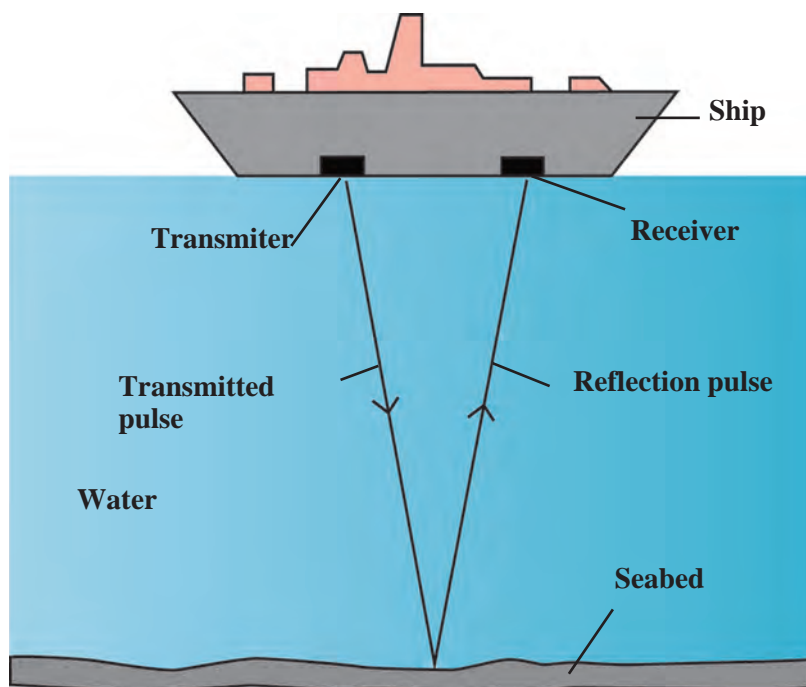

12.4 The SONAR technique

The receiver converts the ultrasonic sound into electrical signals and these signals are properly interpreted. The time difference between transmission and reception is noted. This time and the velocity of sound in water give the distance from the ship, of the object which reflects the waves.

SONAR is used to determine the depth of the sea. SONAR is also used to search underwater hills, valleys, submarines, icebergs, sunken ships etc.

Sonography

Sonography technology uses ultrasonic sound waves to generate images of internal organs of the human body. This is useful in finding out the cause of swelling, infection, pain, etc. The condition of the heart, the state of the heart after a heart attack as well as the growth of foetus inside the womb of a pregnant woman are studied using this technique.



Examination procedure



Sonography machine

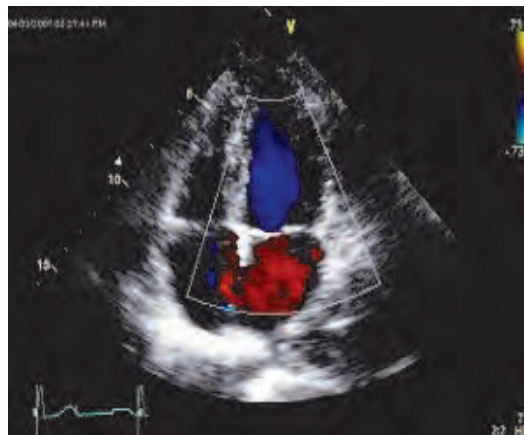

Image obtained

12.5 Sonography machine and images obtained

This technique makes use of a probe and a gel. The gel is used to make proper contact between the skin and the probe so that the full capacity of the ultrasound can be utilized.

The gel is applied to the skin outside the internal organ to be studied. High frequency ultrasound is transmitted inside the body with the help of the probe. The sound reflected from the internal organ is again collected by the probe and fed to a computer which generates the images of the internal organ. As this method is painless, it is increasingly used in medical practice for correct diagnosis.



Find out

How is ultrasound used in medical science?



Always remember



Developments in science have led to advances in technology which have helped us make much progress. However, every coin has two sides and the misuse of science has had serious consequences for human life. The sonography technique can help to follow the growth and well being of an unborn baby. But the increasing incidence of female foeticide as a result of the discrimination between the girl and the boy child is an example of the grave misuse of this technique. Female foeticide is now a cognizable offence under the PNDT Act.

Human ear

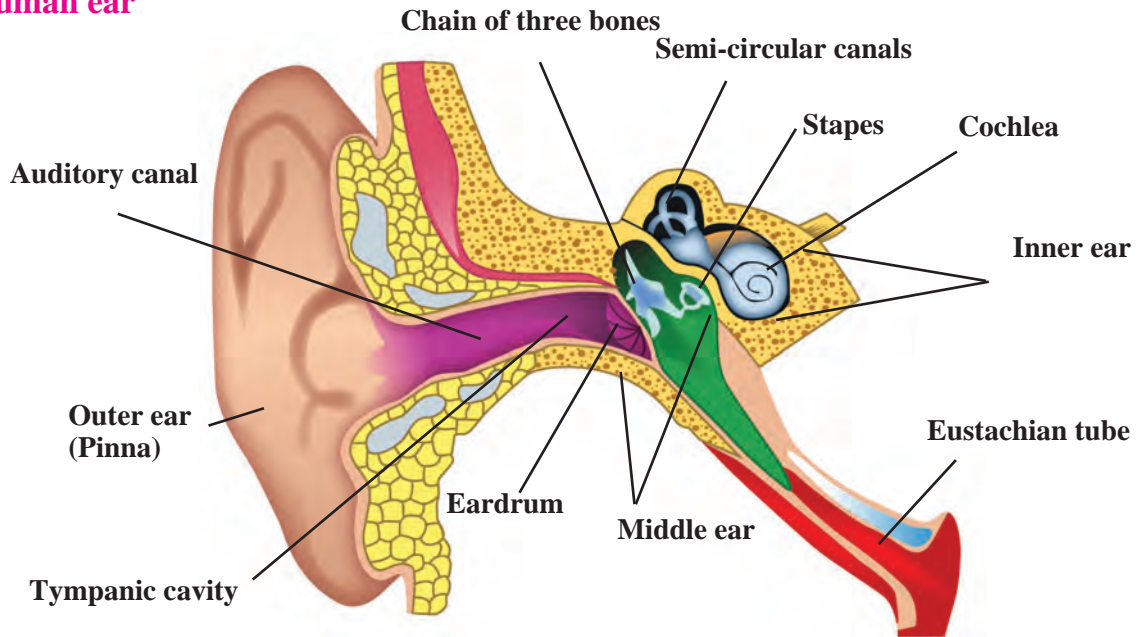

12.6 Structure of the human ear

The ear is an important organ of the human body. We hear sounds because of our ear. When sound waves fall on the eardrum, it vibrates. These vibrations are converted into electrical signals which travel to the brain through nerves. The ear can be divided into three parts: 1. Outer ear 2. Middle ear 3. Inner ear.

Outer ear or Pinna

The outer ear collects the sound waves and passes them through a tube to a cavity in the middle ear. Its peculiar funnel like shape helps to collect and pass sounds into the middle ear.

Middle ear

There is a thin membrane in the cavity of the middle ear called the eardrum. When a compression in a sound wave reaches the eardrum, the pressure outside it increases and it gets pushed inwards. The opposite happens when a rarefaction reaches there. The pressure outside decreases and the membrane gets pulled outwards. Thus, sound waves cause vibrations of the membrane.

Inner ear

The auditory nerve connects the inner ear to the brain. The inner ear has a structure resembling the shell of a snail. It is called the cochlea. The cochlea receives the vibrations coming from the membrane and converts them into electrical signals which are sent to the brain through the nerve. The brain analyses these signals.



Always remember

The ear is an important sensory organ. Sticks or other pointed objects should never be inserted into the ear for cleaning it. Also, one should not hear very loud music using earphones. It may cause grave injury to the eardrum.

Solved examples

Example 1 : How long will it take for a sound wave of 25 cm wavelength and 1.5 kHz frequency of, to travel a distance of 1.5 km?

Given : Frequency (ν) = 1.5 kHz

$$= 1.5 \times 10^3 \text{ Hz}$$

Wavelength (λ) = 25 cm = 0.25 m

distance (s) = 1.5 km = 1.5×10^3 m

time (t) = ?

Velocity of sound = Frequency \times Wavelength

$$v = \nu \lambda$$

$$v = 1.5 \times 10^3 \times 0.25$$

$$v = 0.375 \times 10^3$$

$$v = 375 \text{ m/s}$$

$$\text{Time} = \frac{\text{Distance}}{\text{Velocity}}$$

$$t = \frac{s}{v} = \frac{1.5 \times 10^3}{375} = \frac{1500}{375} = 4 \text{ s}$$

The sound wave takes 4 s to travel the distance of 1.5 km.

Example 3 : Sound waves of wavelength 1 cm have a velocity of 340 m/s in air. What is their frequency? Can this sound be heard by the human ear?

Given : Wavelength = $\lambda = 1 \text{ cm} = 1 \times 10^{-2} \text{ m}$, Velocity of sound = $v = 340 \text{ m/s}$

$$v = \nu \lambda$$

$$\therefore \nu = \frac{v}{\lambda} = \frac{340}{1 \times 10^{-2}} = 340 \times 10^2$$

$$\therefore \nu = 34000 \text{ Hz}$$

This frequency is higher than 20000 Hz and, therefore, this sound cannot be heard by the human ear.

Example 2 : Ultrasonic waves are transmitted downwards into the sea with the help of a SONAR. The reflected sound is received after 4 s. What is the depth of the sea at that place?

(Velocity of sound in seawater = 1550 m/s)

Given :

Velocity of sound in seawater = 1550 m/s

Time for echo to be heard = 4s

Time taken by sound waves to reach the bottom of the sea = $\frac{4}{2} = 2 \text{ s}$

$$\text{Velocity} = \frac{\text{Distance}}{\text{Time}}$$

Distance = Velocity \times Time

$$= 1550 \times 2 = 3100 \text{ m}$$

Depth of the sea at that place = 3100 m



The SONAR technology was first developed during World War I to detect enemy submarines. This technology can be used in air also. In fact, bats use this technique to detect obstacles in their path so that they can avoid them and fly freely even in the dark.

Exercises



1. Fill in the blanks and explain.

- Sound does not travel through
- The velocity of sound in steel is than the velocity of sound in water.
- The incidence of in daily life shows that the velocity of sound is less than the velocity of light.
- To discover a sunken ship or objects deep inside the sea, technology is used.

2. Explain giving scientific reasons.

- The roof of a movie theatre and a conference hall is curved.
- The intensity of reverberation is higher in a closed and empty house.
- We cannot hear the echo produced in a classroom.

3. Answer the following questions in your own words.

- What is an echo? What factors are important to get a distinct echo?
- Study the construction of the Golghumat at Vijapur and discuss the reasons for the multiple echoes produced there.
- What should be the dimensions and the shape of classrooms so that no echo can be produced there?

4. Where and why are sound absorbing materials used?

5. Solve the following examples.

- The speed of sound in air at 0°C is 332 m/s . If it increases at the rate of 0.6 m/s per degree, what will be the temperature when the velocity has increased to 344 m/s ?

(Ans: 200°C)

- Nita heard the sound of lightning after 4 seconds of seeing it. What was the distance of the lightning from her?

(The velocity of sound in air is 340 m/s ?)

(Ans: 1360 m)

- Sunil is standing between two parallel walls. The wall closest to him is at a distance of 660 m . If he shouts, he hears the first echo after 4 s and another after another 2 seconds .

- What is the velocity of sound in air?
- What is the distance between the two walls?

(Ans: 330 m/s ; 1650 m)

- Hydrogen gas is filled in two identical bottles, A and B, at the same temperature. The mass of hydrogen in the two bottles is 12 gm and 48 gm respectively. In which bottle will sound travel faster? How many times as fast as the other?

(Ans: In A; Twice)

- Helium gas is filled in two identical bottles A and B. The mass of the gas in the two bottles is 10 gm and 40 gm respectively. If the speed of sound is the same in both bottles, what conclusions will you draw?

(Ans: Temperature of B is 4 times the temperature of A.)

Project :

Collect information about the musical instrument called *Jaltarang* and find out how the different notes are produced in it.



13. Carbon : An Important Element



- Carbon – occurrence, properties, allotropes ➤ Hydrocarbons
- Carbon dioxide and methane – occurrence, properties, uses



Can you recall?

1. What is an element? What are the different types of elements?
2. What remains behind on complete combustion of any organic compound?
3. What type of element is carbon? Give some information about it.

You have learnt that carbon is a non-metallic element. You have also learnt about its occurrence in nature in the form of some compounds.



Try this

1. Take some milk in an evaporating dish. Heat the evaporating dish on a Bunsen burner. What remains behind at the bottom of an evaporating dish on complete evaporation of the milk?

2. Take small samples of sugar, wool, dry leaves, hair, seeds, split pulses and plastic in separate test tubes. Heat each test tube and observe the changes taking place in the substances.

What does the black substance remaining in each test tube indicate?

Carbon

The element carbon is available abundantly in the nature and occurs in free as well as in the combined state. In this chapter, let us study the properties of the non-metallic element carbon.

Make a list of all substances/objects that you use in daily life from morning till night and divide those substances into the columns in the following table.

1. Symbol of carbon – C
2. Atomic number – 6
3. Atomic mass – 12
4. Electron configuration – 2,4
5. Valency – 4
6. Non-metallic element

Metallic objects	Earthen/glass objects	Other objects/substances

Now look at the list of objects in the last column. It contains foodstuffs, clothes, medicines, fuels, wooden objects, etc. Carbon is the common and important constituent of all these substances.



Can you tell?

What is a compound? How are compounds formed?

Compounds obtained directly or indirectly from plants and animals are called organic compounds and compounds obtained from minerals are called inorganic compounds. All the organic compounds contain carbon. Carbon is the main element even in cellular DNA and RNA that transfer hereditary characteristics from one generation to the next.

An introduction to scientists

The German chemist Wohler synthesized an organic compound urea from an inorganic compound ammonium cyanate. Ever since then, many organic compounds have been made from inorganic compounds. Carbon was found to be the main element in all these compounds. Hence, organic chemistry is also referred to as chemistry of carbon compounds.



Occurrence of carbon

The name 'carbon' is derived from the Latin word 'carbo' meaning coal. Carbon is found in nature in free as well as compound state. Carbon in the free state is found as diamond and graphite, and in the combined state in the following compounds.

1. As carbon dioxide and in the form of carbonates such as calcium carbonate, marble, calamine (ZnCO_3)
2. Fossil fuel – coal, petroleum, natural gas
3. Carbonaceous nutrients – carbohydrates, proteins, fats
4. Natural fibres – cotton, wool, silk

Science capsule

In the earth's crust, carbon is present to the extent of approximately 0.27% in the form of carbonate, coal, petroleum. In atmosphere, the proportion of carbon in the form of carbon dioxide is approximately 0.03 %.

Some types of plants which grow on the ocean floor convert carbon in marine water into calcium carbonate.

Properties of carbon

Allotropic nature of Carbon

Allotropy – Some elements occur in nature in more than one form. The chemical properties of these different forms are the same but their physical properties are different. This property of elements is called allotropy. Like carbon, sulphur and phosphorus also exhibit allotropy.

Allotropes of carbon

A. Crystalline forms

1. A crystalline form has a regular and definite arrangement of atoms.
2. They have high melting points and boiling points.
3. A crystalline form has a definite geometrical shape, sharp edges and plane surfaces.

Carbon has three crystalline allotropes.

1. Diamond

Diamonds are found in India mainly in Golconda (Telangana) and Panna (Madhya Pradesh). Diamonds are also found in South Africa, Brazil, Belgium, Russia and America.

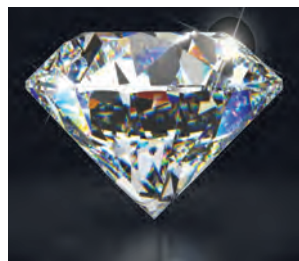

13.1 Diamond

Structure : In diamond, every carbon atom is bonded to four neighbouring atoms by covalent bonds. Due to this three dimensional structure, diamond become very hard.

Properties

1. Brilliant and pure diamond is the hardest natural substance.
2. The density of diamond is 3.5 g/cm^3 .
3. The melting point of diamond is $3500 \text{ }^\circ\text{C}$
4. When diamond is heated at $800 \text{ }^\circ\text{C}$ in the presence of oxygen CO_2 is given away. In this process no other product besides CO_2 is formed.
5. Diamond does not dissolve in any solvent.
6. Acids/bases have no effect on diamond.
7. Diamond is a bad conductor of electricity as it does not have free electrons.

Uses

1. Diamonds are used in glass cutting and rock drilling machines.
2. Diamonds are used in ornaments.
3. Diamond knives are used in the eye surgery.
4. Diamond dust is used for polishing other diamonds.
5. Diamond is used to make windows giving protection from radiation in space and in artificial satellites.

2. Graphite

Graphite is found in the natural state in Russia, New Zealand, America and India. The lead used in pencil is made by mixing graphite with clay. This process was discovered by Nicholas Jacques Conte in 1795.

Structure : Every carbon atom in graphite is bonded to three other carbon atoms in such a way that a hexagonal layered structure is formed. A graphite crystal is made of many sheets or layers of carbon atoms. These layers slip over each other on applying pressure. One layer of graphite is called graphene.

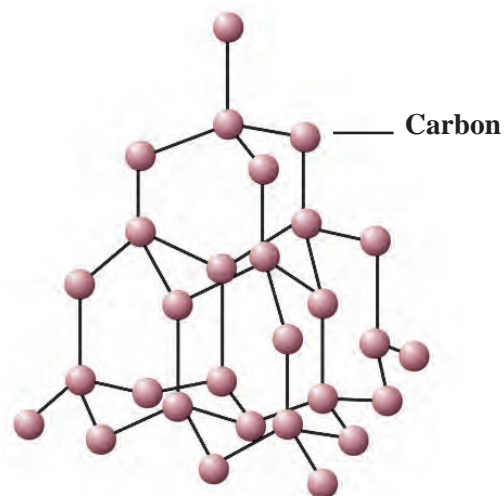

13.2 Structure of carbon atoms in diamond

A peep into the past

Once upon a time, India was famous for the 'Kohinoor' diamond. This diamond was found in the 13th century in the mine at Guntur (Andhra Pradesh). Its weight was 186 carats.

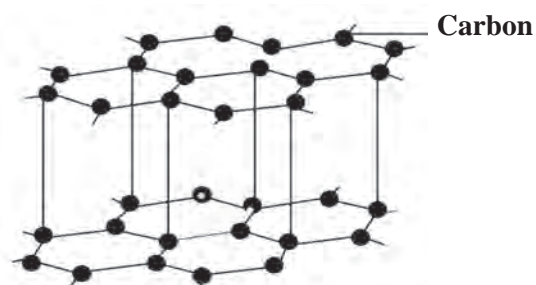

13.3 Graphite and structure of carbon atoms in graphite



Try this

Apparatus : Pencil, electrical wires, battery/cell, small bulb, water, kerosene, test tubes, lead pencil, etc.

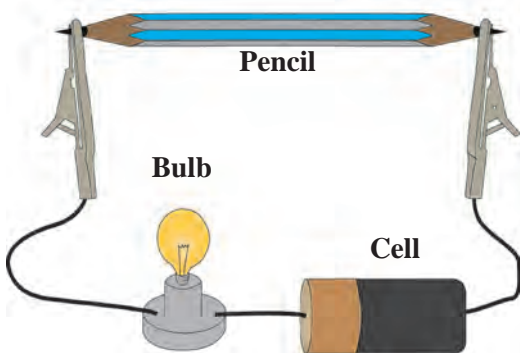

13.4 Flow of electric current through graphite

Procedure :

1. Remove the lead from a pencil, and feel it with your fingers. What colour is it? Try to break the lead with your hand.
2. Assemble the apparatus as shown in the diagram. Start the electric current in the circuit. Observe. What did you find?
3. Take some water in a test tube. Take some kerosene in another test tube. Put lead dust in both the test tubes. What did you find?

Properties of graphite

1. Graphite found in nature is black, soft, brittle and slippery.
2. Inside each layer of graphite, free electrons move continuously within the entire layer. That is why graphite is a good conductor of electricity.
3. Due to the layered structure graphite can be used for writing on paper.
4. The density of graphite is 1.9 to 2.3 g/cm³.
5. Graphite does not dissolve in most solvents.

Uses of graphite

1. Graphite is used for making lubricants.
2. Graphite is used for making carbon electrodes.
3. Graphite is used in pencils for writing.
4. Graphite is used in paints and polish.
5. Graphite is used in arc lamps which give a very bright light.



Buckytubes (Carbon nano-tube)

3. Fullerene

Fullerene, an allotrope of carbon, is rarely found in nature. It is found in soot and in interstellar space. The first example of fullerene is Buckminsterfullerene (C₆₀). This allotrope of carbon is named fullerene after the architect Richard Buckminster Fuller because the structure of C₆₀ resembles the structure of the geodesic dome he designed.

Harold Kroto, Robert Curl and Richard Smalley were given the Nobel prize in chemistry 1996, for the discovery of this carbon allotrope, fullerene C₆₀.

C₆₀, C₇₀, C₇₆, C₈₂ and C₈₆ are other examples of fullerene. Their molecules occur in small numbers in soot.

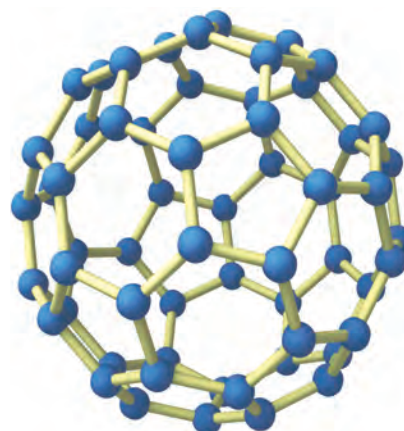

Buckyball (C₆₀)

13.5 Structure of fullerene

Properties

1. Molecules of fullerenes are found in the form of buckyballs and buckytubes.
2. There are 30 to 900 carbon atoms in one molecule of a fullerene.
3. Fullerenes are soluble in organic solvents such as carbon disulphide, chlorobenzene.

Uses

1. Fullerenes are used as insulators.
2. Fullerenes are used as a catalyst in water purification.
3. At a certain temperature fullerene exhibits superconductivity.

B. Non-crystalline / Amorphous forms

The arrangement of carbon atoms in this form is not regular. Coal, coke are the non-crystalline forms of carbon.

1. Coal : Coal is a fossil fuel. It contains carbon, hydrogen and oxygen. It also contains nitrogen, phosphorus and sulphur. It occurs in the solid state. It is of four types.

a. Peat : Formation of peat is the first step in the formation of coal. It contains a high proportion of water and less than 60% of carbon. Therefore, not much heat can be obtained from peat.

b. Lignite : Peat was transformed into Lignite due to increased pressure and temperature inside the earth. It contains 60 to 70% of carbon. Lignite is the second step of the formation of coal.

c. Bituminous coal : Bituminous coal was formed as the third step of formation of coal. It contains 70 to 90% of carbon.

d. Anthracite : Anthracite is known as the pure form of coal. This coal is hard and contains about 95% of carbon.

2. Charcoal : The charcoal that is made from animals is made from their bones, horns, etc. On the other hand, the charcoal made from plants is formed by combustion of wood in an insufficient supply of air.

Uses of coal :

1. Coal is used as fuel in factories and homes.
2. Coal is used to obtain coke, coal gas and coal tar.
3. Coal is used in thermal power plants for generation of electricity.
4. Charcoal is used in purification of water and organic material.

3. Coke : The pure coal that remains when coal gas has been taken away from coal, is called coke.

Uses of coke :

1. Used as domestic fuel.
2. Coke is used as a reducing agent.
3. Coke is used in production of aeriform fuel such as water gas ($\text{CO} + \text{H}_2$) and producer gas ($\text{CO} + \text{H}_2 + \text{CO}_2 + \text{N}_2$).



Peat



Lignite

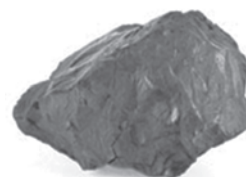

Bituminous coal



Anthracite



Coke

13.6 Non-crystalline forms of carbon

Hydrocarbons : basic organic compounds

Along with carbon, the element hydrogen is also included in most organic compounds. The compounds formed from only carbon and hydrogen are called basic organic compounds. These are also called hydrocarbons.

The electronic configuration of carbon is 2, 4. If four electrons are added to the second orbit of carbon, its octet becomes complete and its electronic configuration becomes stable like that of the nearest inert gas neon (2, 8). Therefore, the valency of carbon is 4. However, this occurs by sharing of electron rather than a give and take of electrons. In other words a carbon atom can form four covalent bonds with other carbon atoms or atoms of different elements.

When a carbon atom shares one electron each with four hydrogen atoms and forms four C-H bonds, a methane CH_4 molecule is formed.

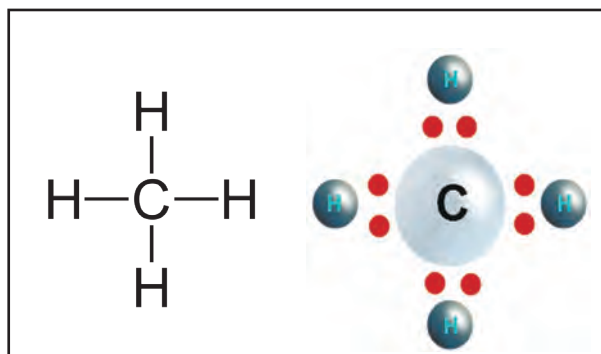

Properties of covalent compounds

1. Covalent compounds have low melting points and boiling points.
2. Generally they are insoluble in water and soluble in organic solvents.
3. They are poor conductors of heat and electricity.

13.7 Structural formula and electron dot model of methane

Saturated and unsaturated hydrocarbons

A carbon atom exhibits a characteristic property. It can form a chain of carbon atoms by forming covalent bonds with other carbon atoms. The hydrocarbons having only single bonds between carbon atoms are called saturated hydrocarbons. For example ethane (C_2H_6) which is ($\text{CH}_3\text{—CH}_3$), propane ($\text{CH}_3\text{—CH}_2\text{—CH}_3$).

Some hydrocarbons have a multiple bond between two carbon atoms. A multiple bond can be a double bond or a triple bond. Hydrocarbons having at least one multiple bond are called unsaturated hydrocarbons. For example, ethene ($\text{H}_2\text{C=CH}_2$), ethyne ($\text{HC}\equiv\text{CH}$), propene ($\text{CH}_3\text{-CH=CH}_2$), propyne ($\text{CH}_3\text{-C}\equiv\text{CH}$).



Use your brain power !

Does an electric charge form on atoms when a covalent bond is formed between them? Why is a single bond between two carbon atoms strong and stable?



Try this

Apparatus : 3 conical flasks, stirrer.

Chemicals : Water, kerosene, cooking oil, coal powder, etc.

Procedure : Take 3 conical flasks and take cooking oil, water and kerosene respectively in each. Add half a spoonful of coal powder in each of the conical flasks and stir with the help of stirrer. Observe the mixtures in the three conical flasks.



13.8 Solubility of coal in water



Use your brain power!

1. In which of the solvents- water, kerosene and cooking oil does the coal powder dissolve?
2. What inference will you draw about the solubility of carbon?

Reaction of carbon with oxygen



Try this

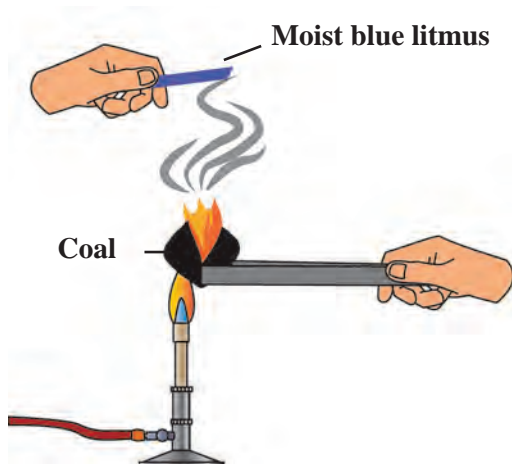

13.9 Reaction of carbon with oxygen

Apparatus : Test tube, straw, limewater, etc.

Procedure : Take freshly prepared limewater in a test tube. Blow for sometime into the limewater through the straw and observe the limewater. What did you see?

What might be the reason behind the change?

Apparatus : Coal, match box, moist litmus paper, etc.

Procedure : Ignite the coal. Hold the moist blue litmus paper over the gas released on igniting the coal. Note the observation.

1. With which gas in the air does the coal react on igniting?
2. What is the substance formed?
3. What change takes place in the litmus paper?
4. Write down the chemical reaction taking place in the above procedure.

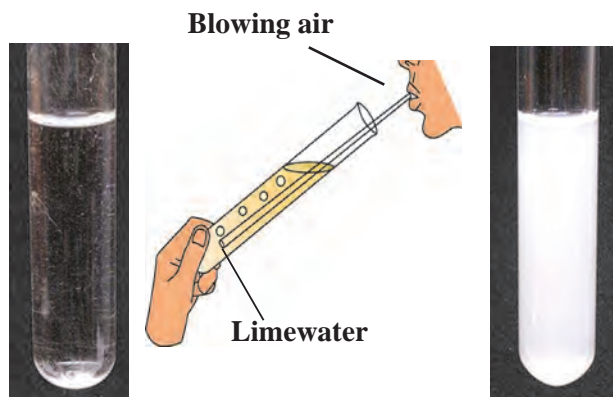

13.10 Reaction of limewater with CO₂

Carbon dioxide

Molecular formula: CO₂, **molecular mass :** 44, **melting point :** - 56.6 °C

Occurrence : Carbon dioxide occurs in the air in the free state to the extent of about 0.03%. Exhaled air contains about 4% of CO₂. CO₂ is present as a salt in chalk and Shahabad tiles/ marble/ limestone. CO₂ is given out in the combustion of wood and the fossil fuel coal.



Try this

Apparatus : Retord stand, round bottom flask, thistle funnel, gas delivery tube, gas jars.

Chemicals : Calcium carbonate (Pieces of Shahabad tiles / marble pieces / limestone), dilute hydrochloric acid.

Procedure :

1. Assemble the apparatus as shown in the figure. While assembling place CaCO_3 in the round bottom flask.
2. Add dilute HCl in the flask through thistle funnel. See to it that the end of the funnel dips in the acid.
3. CO_2 is formed as a result of the reaction between CaCO_3 and HCl. Collect this gas in four to five gas jars. The chemical equation of the above reaction is as follows.

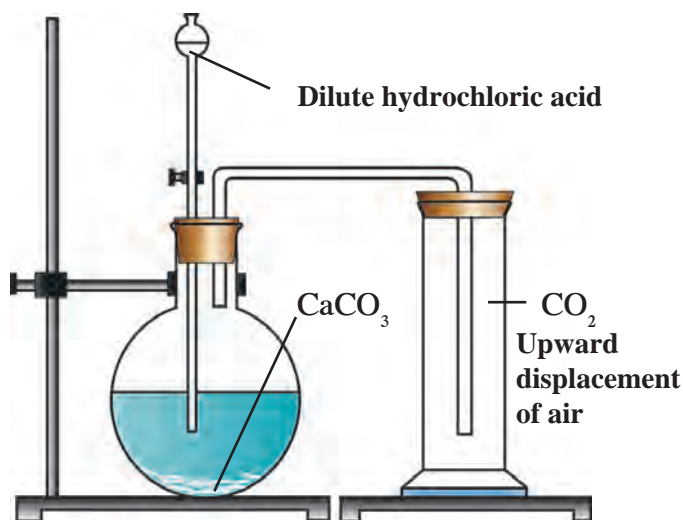

13.11 Preparation of carbon dioxide

Physical and chemical properties of carbon dioxide

1. Observe the colour of the gas formed in the above experiment.
2. Smell the gas in the gas jar.

Use separate gas jars for the activities 3 to 7 below:

3. Remove the lid of a gas jar and put some limewater in it.
4. Place a burning candle in a gas jar.
5. Drop a small amount of a solution of some universal indicator in one gas jar filled with CO_2 and shake it.
6. Pour some water in a gas jar and shake it.
7. Moisten a blue and a red litmus paper and drop them in a gas jar of CO_2 .

Enter your observations in all the above activities in the following table.

Physical properties of CO_2

Test	Observations
Odour	
Colour	

Chemical properties of CO_2

Test	Observations
Burning candle	
Universal indicator	
Limewater	
Water	
Litmus paper	



Use your brain power!

Is the density of CO_2 more or less than that of air?

Some more chemical properties of carbon dioxide

1. Sodium carbonate is formed when carbon dioxide is passed through an aqueous solution of sodium hydroxide (Sodium carbonate = washing soda)

Chemical equation of the reaction $2\text{NaOH} + \text{CO}_2 \rightarrow \text{Na}_2\text{CO}_3 + \text{H}_2\text{O}$

2. Sodium bicarbonate is formed on passing CO_2 through an aqueous solution of sodium carbonate. (sodium bicarbonate = baking soda)

Chemical equation of the reaction $\text{Na}_2\text{CO}_3 + \text{H}_2\text{O} + \text{CO}_2 \rightarrow 2\text{NaHCO}_3$

- a. Write down the equation of the chemical reaction taking place between water and carbon dioxide in the above experiment.
- b. Write down the equation of the chemical reaction taking place on putting limewater in the gas jar of CO_2 .

Uses of carbon dioxide

1. CO_2 is used to make aerated drinks
2. Solid carbon dioxide is used in cold storage and also to keep milk and milk products and frozen substances cool during transport. It is also used for getting special effects of a mist in dramas and movies.
3. CO_2 obtained by chemical reaction or kept under pressure is used in fire extinguishers.
4. Liquefied CO_2 is used to remove caffeine from coffee.
5. Liquid CO_2 is used as solvent in modern eco-friendly dry cleaning.
6. Plants use CO_2 in air for photosynthesis.

Regular fire extinguisher

A fire extinguisher contains sodium bicarbonate powder. There is also dilute sulphuric acid placed in a glass capsule. The capsule breaks on pressing the knob, the sulphuric acid comes in contact with the sodium bicarbonate and the two react chemically to release CO_2 which comes out.

CO_2 based fire extinguishers do not cause corrosion and are non conductors of electricity. Therefore these are used when electrical and electronic equipment catches fire.

CO_2 based fire extinguishers are used to extinguish small scale fire. It is beyond their capacity to extinguish a big fire.

In modern fire extinguishers liquid and solid CO_2 is filled under pressure. On reducing the pressure it becomes gaseous and comes out forcefully through the horn-like hose pipe.

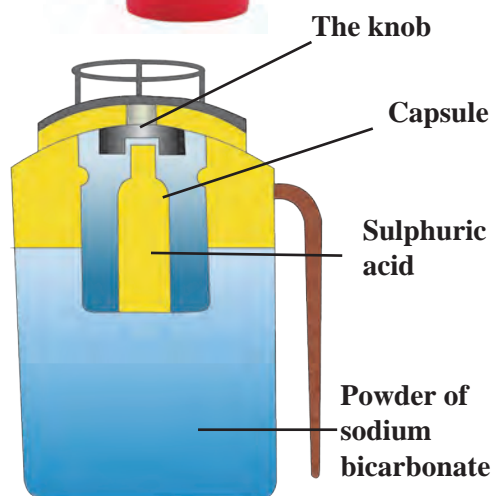

13.12 Internal structure of fire extinguisher

Chemical reaction $2\text{NaHCO}_3 + \text{H}_2\text{SO}_4 \rightarrow \text{Na}_2\text{SO}_4 + 2\text{H}_2\text{O} + 2\text{CO}_2 \uparrow$

Nowadays, many types of fire extinguishers are used. Collect more information about the way CO_2 is used in them to extinguish a fire.

Methane – molecular formula CH₄, molecular mass – 16

Occurrence

1. Methane occurs in natural gas to the extent of 87%.
2. Decomposition of organic matter in the absence of air (anaerobic) produces methane.
3. Methane is present in biogas.
4. Methane is found in coal mines.
5. Methane is found at the surface of marshy places which is why it is also called marsh gas.
6. On heating a mixture of hydrogen and carbon monoxide gases at 300 °C in the presence of nickel (catalyst) methane gas is formed.
7. Fractional distillation of natural gas gives methane in pure form.

Physical properties of methane

1. Melting point of methane is (-182.5 °C).
2. Boiling point of methane is (-161.5 °C).
3. It is a colourless gas.
4. The density of liquid methane is less than that of water.
5. Methane is sparingly soluble in water. It is highly soluble in organic solvents like gasoline, ether and alcohol.
6. Methane is in gaseous state at room temperature.

Chemical properties of methane

1. Methane is highly inflammable. It burns by reacting with oxygen to give a bluish flame. In this reaction, 213 kcal/mol of heat is given out. Methane burns completely.

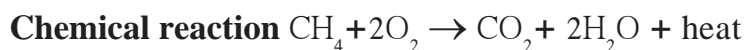

2. Chlorination

Methane and chlorine gases react with each other at the temperature of 250 °C to 400 °C in presence of ultraviolet light and form mainly methyl chloride (chloromethane) and hydrogen chloride. This reaction is called chlorination of methane.

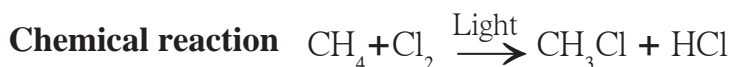

Uses of methane

1. Methane in the form of natural gas is used in industries such as fabric mills, paper mills, food processing industry, petrol purification.
2. Being the smallest hydrocarbon, the proportion of CO₂ released in the combustion of methane is small and, therefore, it is used as a domestic fuel.
3. Methane is used for production of organic compounds such as ethanol, methyl chloride, methylene chloride and acetylene.

Methane gas was discovered by the Italian scientist Alessandro Volta between 1776 and 1778 while he was studying the gases found in marshy land.

Using ICT

Prepare a detailed report on carbon. Use computer applications such as Notepad, Word for this purpose and send the reports to others.

Websites -<https://www.boundless.com/chemistry/>, www.rsc.org/learn-chemistry

Biogas plant : Animal dung, dry leaves, wet garbage get decomposed by anaerobic microbes in a biogas plant. This produces methane gas also called biogas. Biogas is a very cheap fuel option which meets the demand for cooking gas. It is also used for production of an electricity. Biogas contains about 55% to 60% methane and the rest is carbon dioxide. Biogas is a fuel which is convenient to use and, in addition to this, a very good manure is also produced as a side product of the process.

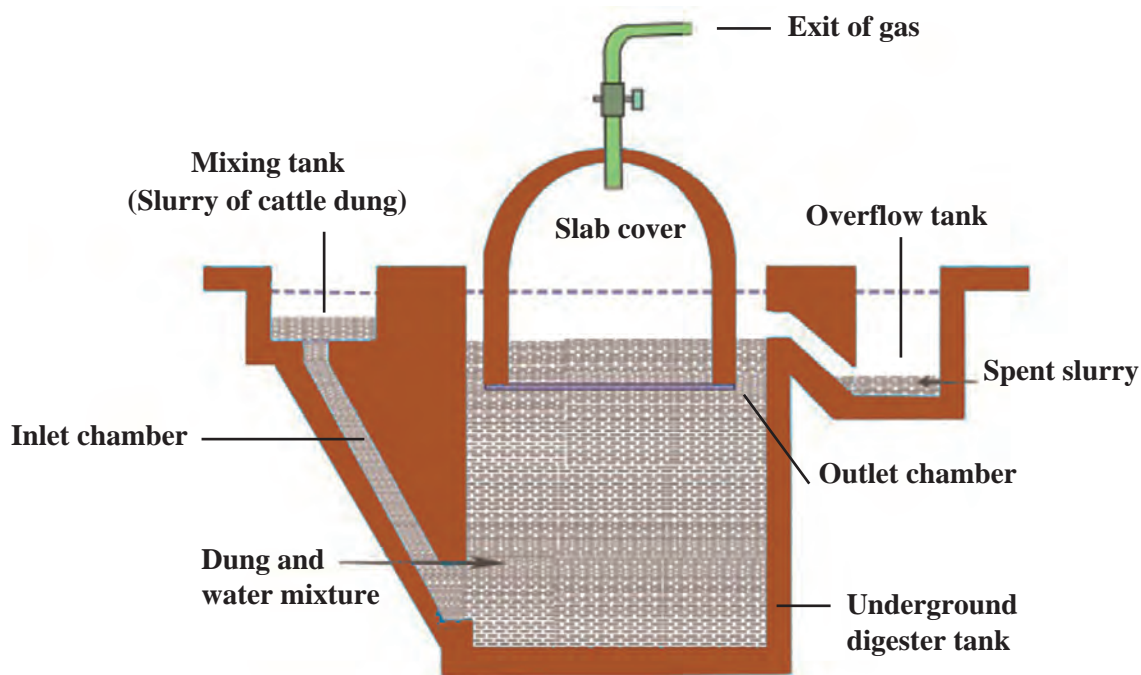

13.13 Biogas plant

Biogas production process

Production of biogas is an anaerobic process. It takes place in two stages.

1. Production of acids

The microbes act on the biodegradable complex organic compound and produce organic acids.

2. Methane gas production

The methanogenic bacteria act on the organic acids to produce methane gas

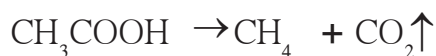

Find out

Visit a biogas plant and get to know the actual functioning of the plant. Find out which electrical instruments are run on that plant.



1. Select the proper option and complete the statements

(single, all, double, ionic, carbon, give and take, hydrogen, multiple, share, most, covalent)

- A carbon atom forms a bond with other atoms. In this bond the two atomselectrons.
- All the carbon bonds in a saturated hydrocarbon electrons.
- At least one carbon bond in an unsaturated hydrocarbon is
- is the essential element in all the organic compounds.
- The element hydrogen is present in organic compound.

2. Answer the following questions

- Why are carbon and its compounds used as fuels?
- In which compound forms does carbon occur?
- Write the uses of diamond.

3. Explain the difference:

- Diamond and graphite.
- Crystalline and non-crystalline forms of carbon.

4. Write scientific reasons

- Graphite is a conductor of electricity.
- Graphite is not used in ornaments.
- Limewater turns milky when CO_2 is passed through it.
- Biogas is an eco-friendly fuel.

5. Explain the following.

- Diamond, graphite and fullerenes are crystalline forms of carbon.
- Methane is called marsh gas.
- Petrol, diesel, coal are fossil fuels.
- Uses of various allotropes of carbon.
- Use of CO_2 in fire extinguisher.
- Practical uses of CO_2 .

6. Write two physical properties each.

- Diamond
- Charcoal
- Fullerene

7. Complete the following Chemical reactions.

-+..... \rightarrow $\text{CO}_2 + 2\text{H}_2\text{O} + \text{Heat}$
-+..... \rightarrow $\text{CH}_3\text{Cl} + \text{HCl}$
- $2 \text{NaOH} + \text{CO}_2 \rightarrow$+.....

8. Write answers to the following in detail.

- What are the different types of coal? What are their uses?
- How will you prove experimentally that graphite is good conductor of electricity?
- Explain the properties of carbon.
- Classify carbon.

9. How will you verify the properties of carbon dioxide?

Project

Make a model of a biogas plant and make a presentation in the class about the process of gas production.



14. Substances in Common Use



- Important salts in day to day life - NaCl , NaHCO_3 , Na_2CO_3
- Radioactive substances ➤ Some chemical substances in day to day life



Can you recall?

1. What are the important substances that we use in day to day life? For what purposes do we use them?
2. How are the various substances in day to day use classified from the scientific point of view?

We use various substances in day to day life. We have previously learnt in some detail about a few of them, their uses and constituents and the method of their preparation.



Classify

The names of some substances in everyday use are given below. Classify them into groups like acids, bases, metals, non-metals and salts.

Substances : Table salt, soap, toothpaste, baking soda, water, curds, milk, alum, iron, sulphur, washing powder.

Important salts in daily life



Can you tell?

What are salts?

The ionic compounds which do not contain H^+ and OH^- ions and contain only one kind of cation and anion are called simple salts. For example, Na_2SO_4 , K_3PO_4 , CaCl_2 .

Inorganic substances occur naturally in the form of salts rather than acids or bases. About 80 million tons of salts are added every year to seawater. Therefore, the sea is said to be a rich source of salts. In fact, the sea is a rich source of several salts of various elements such as chlorine, sodium, magnesium, potassium, calcium, bromine., However, we also use other salts apart from these in day to day life. Let us learn more about them.



Do you know?

The important salts found in sea water

1. Sodium chloride
2. Magnesium chloride
3. Magnesium sulphate
4. Potassium chloride
5. Calcium carbonate
6. Magnesium bromide



Try this

Prepare saturated solutions of some salts and put 2-3 drops of the universal indicator in them and note your observations in the table alongside.

Salt	Original color (of the solution)	Color on addition of universal indicator	pH value	Nature
Table salt	Colorless	Green	7	Neutral
Soap				
Washing soda				
Baking soda				
Baking powder				
POP				



Can you tell?

1. What is the strip shown below? What is it used for?
2. How is it determined whether a substance is acidic, basic or neutral?
3. Make a list of substances in day to day use in accordance with their pH value (1 to 14).

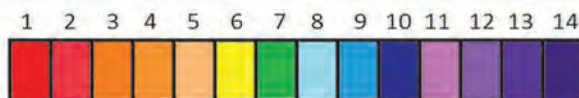

We have seen in the previous lesson that a salt is neutral when its pH value is 7. Such a salt is made from a strong acid and a strong base. The pH value of a salt made from a strong acid and a weak base is less than 7 and it is acidic. On the other hand, the pH value of a salt made from a weak acid and strong base is more than 7 and it is basic. Let us now learn about some salts of everyday use.

Sodium chloride (Table salt- NaCl)

Table salt, or common salt, which gives a salty taste to food, is the most used of all salts. Its chemical name is sodium chloride. Sodium chloride is formed by a neutralization reaction between sodium hydroxide and hydrochloric acid.

We have already seen that this is a neutral salt and that the pH value of its aqueous solution is 7.



Do you know?



Salt is also obtained from a certain type of rock. This salt is called rock salt. The mineral halite and Himalayan rock salt are some examples of rock salt. This salt is used to treat many diseases.

The 25% aqueous solution of salt is called saturated brine. When $\frac{1}{5}$ of this solution is evaporated the dissolved salt gets crystallized and salt gets separated from the solution.

Properties and uses

1. Common salt is a colourless and crystalline ionic compound. There is no water of crystallization in its crystalline structure.
2. It is a neutral salt, salty in taste.
3. This compound is used for the production of salts like Na_2CO_3 , NaHCO_3 .
4. When an electric current is passed through a saturated solution of sodium chloride (brine) it is electrolysed and hydrogen gas is released at the cathode while chlorine gas is released at the anode. This method is used for production of chlorine gas. In this method an important basic compound NaOH is formed in the cell.

$$2\text{NaCl} + 2\text{H}_2\text{O} \rightarrow 2\text{NaOH} + \text{Cl}_2\uparrow + \text{H}_2\uparrow$$
5. When salt is heated to a high temperature (about 800°C), it melts. This is called the fused state of the salt.
6. When fused salt is electrolysed, chlorine gas is released at the anode and liquid sodium metal, at the cathode.

Sodium bicarbonate (Baking soda – NaHCO_3)

Your mother brings cake on your birthday or makes it at home. She also makes crisp *bhaji*. Have you ever asked your mother what makes the cake porous or the *bhaji* crisp?

Mother adds baking soda in the batter. Baking soda is a white non-crystalline powder. Its chemical name is sodium hydrogen carbonate or sodium bicarbonate and its molecular formula is NaHCO_3 .

Properties and uses

1. NaHCO_3 reacts with moist litmus paper and red litmus turns blue which means that it is basic in nature.
2. It is used to make bread, cake, *dhokla*.
3. Being basic in nature it is used to reduce acidity in the stomach.
4. NaHCO_3 is used to make the active substance CO_2 in the fire extinguisher.
5. Baking soda is used to clean an oven.



Research

What are the constituents of baking powder? Where is the baking powder used?

Bleaching powder (Calcium oxychloride CaOCl_2)



Try this

Take a piece of coloured cloth. Put some saturated solution of bleaching powder on a small part and observe.

What change takes place in the colour of the cloth?

Tap water has a typical strong odour in the rainy season. Have you experienced it? Water in a swimming pool also has the same odour. It is the odour of the chlorine gas used to destroy the microbes in the water. Chlorine gas is a strong oxidizing agent and therefore, it has a strong disinfecting as well as bleaching action.

Chlorine is inconvenient to handle because of its gaseous state. Instead, the solid bleaching powder which has the same effect is more convenient to use. Bleaching powder undergoes slow decomposition due to the carbon dioxide in air and chlorine gas is released. Bleaching powder gets its property because of this release of chlorine gas.

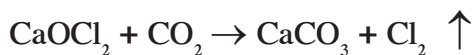

Bleaching powder is obtained by the reaction of chlorine gas with slaked lime.

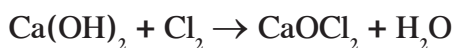

Find out

1. About various types of bleaching powder available in the market.
2. What distinguishes these different types?

Properties and uses

1. Bleaching powder is a yellowish white coloured solid substance.
2. Its chemical name is calcium oxychloride.
3. It has a strong odour of chlorine gas.
4. It is used for disinfection of drinking water at the water works and the water in the swimming pool.
5. It is used for bleaching of cloth.
6. It is used for disinfection by the road side and garbage sites.
7. Dilute sulphuric acid and dilute hydrochloric acid react rapidly with bleaching powder to release chlorine gas completely.

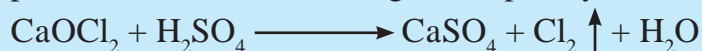

8. Calcium oxychloride reacts slowly with carbon dioxide to form calcium carbonate and chlorine.

Washing soda $\text{Na}_2\text{CO}_3 \cdot \text{H}_2\text{O}$



Try this

Procedure : Take a sample of water from a well or a bore-well, in a beaker, add some soap to it and stir. Then take another sample, add one spoonful of washing soda and stir; then add some soap and stir again. Observe the changes that take place. Which changes did occur? Why do they occur?

The hard water from a well or a bore-well becomes soft on adding washing soda and we come to know this from the lather formed on it. The hardness of water is due to the presence of chlorides and sulphates of calcium and magnesium in it. Na_2CO_3 is added to it to soften such water and make it suitable for use. The reaction with Na_2CO_3 causes the formation of insoluble carbonate salts of magnesium and calcium.

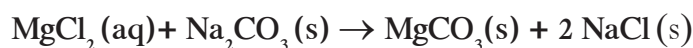

Sodium carbonate is a water soluble salt of sodium. Crystalline sodium carbonate, on keeping, loses its water of crystallization readily and a white powder is obtained. This powder is called washing soda.

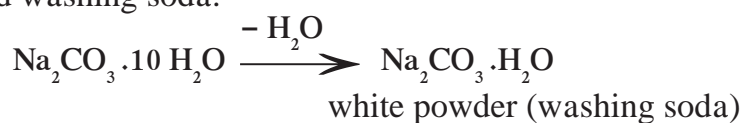

Properties and uses

1. Washing soda is a whitish and odourless powder at room temperature.
2. Litmus has a blue color in its aqueous solution.
3. It is hygroscopic, that is, it absorbs moisture if left exposed to air.
4. It is used mainly for washing clothes.
5. Sodium carbonate is used in the glass and paper industry and also in refining of petrol.

Write down the reaction of Na_2CO_3 with H_2SO_4

Some crystalline salts

You have learnt about water of crystallization in the previous chapter. We use various salts which contain water of crystallization.

Some substances in our daily use which contain water of crystallization

1. Alum (Potash alum - $K_2SO_4 \cdot Al_2(SO_4)_3 \cdot 24H_2O$)
2. Borax ($Na_2B_4O_7 \cdot 10H_2O$)
3. Epsom salt (Magnesium sulphate $MgSO_4 \cdot 7H_2O$)
4. Barium chloride ($BaCl_2 \cdot 2H_2O$)
5. Sodium sulphate (Glauber's salt $Na_2SO_4 \cdot 10 H_2O$)

Collect more information on the properties and uses of the substances listed above.

You have learnt that alum is used in the process of water purification. Because of property of coagulation, the solid impurities in water come together, become heavy and settle to the bottom. As a result, the water above becomes clear.

Blue vitriol is used in the blood test for diagnosing anaemia. In the Bordeaux mixture which is used as a fungicide on fruits like grapes, musk melon, slaked lime it is used with blue vitriol.

Soap



Can you recall?

1. What are detergents?
2. Which chemicals and apparatus will you use in the laboratory for making soap?

When oil or animal fat is boiled with an aqueous solution of sodium or potassium hydroxide, sodium or potassium salts of carboxylic acids (fatty acids) are formed. These salts are called soap. When soap is mixed with hard water calcium and magnesium salts of fatty acids are formed. These being water insoluble they form a precipitate and that is why lather is not formed.

Complete the table by writing the differences between bathing soap and washing soap.

Bathing soap	Washing soap
1. High grade fats and oils are used as the raw material.	1. Low grade fats and oils are used.
2.	2.

Radioactive substances

Elements with a high atomic number such as uranium, thorium, radium have a property of spontaneously emitting invisible, highly penetrating and high energy radiation. This property is called radioactivity. A substance having this property is called a radioactive substance. The nucleus of radioactive elements is unstable. Radiation occurs from an unstable nucleus. Radioactive substances are relevant to our day to day life. However, before going further, let us learn something more about these substances.

Three types of radiation are given out by radioactive substances. These are alpha, beta and gamma rays.

An introduction to scientists

The French scientist Henry Becquerel was studying pitchblende, a compound of uranium. He had kept some unused photographic plates in a cardboard box in a drawer. A key was lying on the box. He happened to leave the uranium compounds on it. After a few days, he washed the plates only to find that the plates were cloudy and showed the shape of the key. As this incidence occurred in the dark, Becquerel inferred that the uranium compounds might be emitting from their interiors, rays like x-rays which penetrate substances. These rays were called Becquerel rays. After a few days, Madame Curie discovered similar properties in compounds of thorium.

Nature of radioactive radiation

In 1889 Rutherford discovered that the radiations emitted by radium were of two types. They are called alpha and beta radiation. Willard discovered the third type namely gamma radiation.

When these rays are allowed to pass through two oppositely charged plates they get separated. This method was introduced by Rutherford in 1902. Rutherford and Willard studied the radiation emitted by radioactive substances. For this purpose, the rays were allowed to pass through an electrical field and a photographic plate was held in their path. It was found that the radiation was divided into three types. One type of radiation deviated slightly towards the negatively charged plate, while the second type of radiation deviated substantially towards the positively charged plate. However, the third type of radiation did not deviate at all in the electrical field. The rays which deviated slightly toward negatively charged plate are called alpha rays, those which deviate substantially towards the positively charged plate are called beta rays and those which do not deviate at all are called gamma rays.

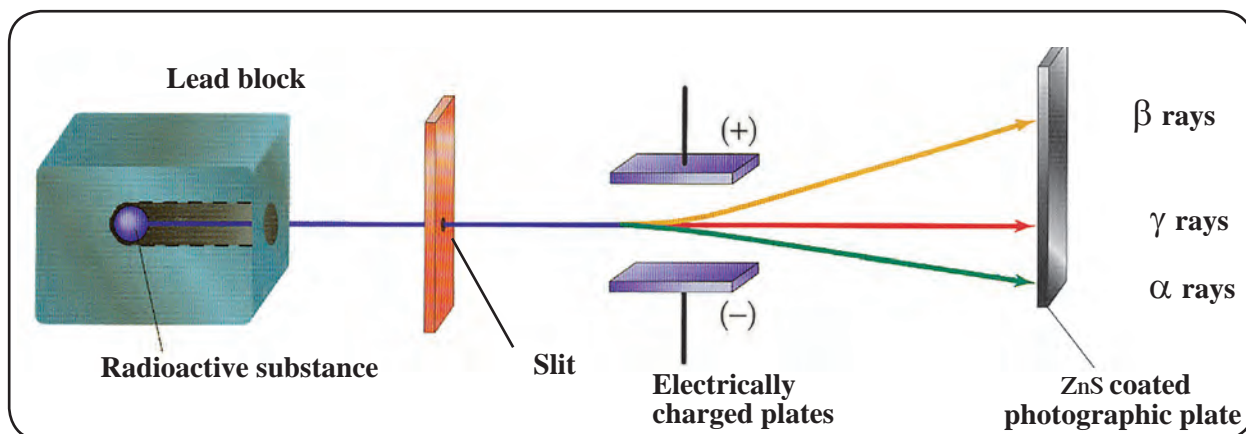

14.1 Alpha, beta and gamma rays



An introduction to scientists : Ernest Rutherford (1871-1937), a scientist from New Zealand did research on radioactivity under the guidance of J.J. Thomson at the Cavendish Laboratory at Cambridge and McGill University, Canada. He showed that the nitrogen atom could be split by bombarding it with alpha particles. This experiment ushered in a new era in the field of Physics.

Characteristics of alpha, beta and gamma rays

Sr. No.	Property	Alpha rays (α)	Beta rays (β)	Gamma rays (γ)
1.	Nature	Current of alpha (He^{++}) particles	Current of beta (e^-) particles	Electromagnetic radiation
2.	Mass	4.0028 u	0.000548 u	No mass
3.	Charge	+2	-1	Electrically neutral
4.	Velocity	1/5 to 1/20 times the velocity of light	1/5 to 9/10 times the velocity of light	Same as the velocity of light
5.	Deviation in the electric field	Attracted toward negatively charged plate	Attracted toward positively charged plate	Not deviated
6.	Penetrating power	Can penetrate an aluminum sheet of thickness < 0.02 mm	Can penetrate an aluminium sheet of thickness 2mm, which is 100 times the penetration of alpha particles.	Can penetrate 15 cm thick lead screen which is 10,000 times the penetration of alpha particles
7.	Ionization power	Very high	Low	Very low
8.	Power to produce fluorescence	Very high	Very low	Low

Uses of radioactive isotopes : It is a misconception that radioactive elements are used only for making an atom bomb. Radioactive isotopes are used in various fields such as scientific research, agriculture, industry, medicine, etc. Radioactive substances are used in two ways.

- a. By using the radiation alone.
- b. By using the radioactive element itself.

Natural radioactivity : Generally, the elements with atomic numbers from 82 to 92 are found to radiate spontaneously in nature. These are called natural radioactive elements.

Artificial radioactive elements – The couple Fredric Joliot Curie and Irene Joliot Curie first invented induced radioactivity. The radioactive elements produced in the nuclear fission processes brought about in the laboratory by bombardment of particles are called artificial radioactive elements. They were awarded the Nobel prize in 1935 for this invention.



Radioactive isotopes are used in various fields as follows

1. Industrial field

Radiography – Internal cracks and voids in cast iron articles and iron solder can be detected with the help of gamma rays. For this purpose, isotopes like cobalt-60, iridium-192 are used in the radiography camera. This technique is used for detecting flaws in metal work.

Measurement of thickness, density and level- It is necessary to maintain the required thickness in the manufacture of aluminium, plastic, iron sheets of differing thickness. In the manufacturing process, a radioactive substance is placed on one side and an instrument to measure radiation on the other. The radiation read by the measuring instrument varies with the thickness of the sheet. Material inside a packing can also be examined by the same technique.

Luminescent paint and radioluminescence – The radioactive substances radium, promethium, tritium with some phosphor are used to make certain objects visible in the dark, for example, the hands of a clock, and certain other objects. Krypton-85 is used in HID (High Intensity Discharge) lamps while promethium-147 is used in portable X-ray units as the source of beta rays.

Use in Ceramic articles – Luminous colours are used to decorate ceramic tiles, utensils, plates, etc. Earlier uranium oxide was used in these paints.

2. Field of agriculture

1. The genes and chromosomes that give seeds properties like fast growth, higher productivity, etc. can be modified by means of radiation.
2. The radioactive isotope cobalt-60 is used for food preservation.
3. Onions, potatoes are irradiated with gamma rays from cobalt-60 to prevent their sprouting.
4. Strontium-90 is used as a tracer in the research on various crops.

Medical science

1. **Polycythemia** : The red blood cell count increases in the disease polycythemia. Phosphorus-32 is used in its treatment.
2. **Bone cancer** : Strontium-89, strontium-90, samarium-153 and radium-223 are used in the treatment of bone cancer.
3. **Hyperthyroidism** : Enlargement of thyroid gland, weight loss in spite of appetite, insomnia are the symptoms of hyperthyroidism. It occurs due to overproduction of hormones by the thyroid gland. Iodine-123 is used in the treatment of hyperthyroidism .
4. **Tumour detection** : Boron-10, iodine-131, cobalt-60 are used in treatment of brain tumour, while arsenic-74 is used in detection of small tumours in the body.

Hazards of radioactive substances and radiation

1. The central nervous system is affected by radioactive radiations.
2. Hereditary defects are generated by bombardment of radiation on D.N.A in the body.
3. Radioactive radiation can penetrate the skin, and causes diseases like skin cancer, leukemia.
4. The radiative pollutants created due to explosions enter the body through air and it is difficult to control them.
5. The radioactive pollutants released in the sea enter the bodies of fishes and through them enter the human body.
6. The radioactive paint on the watch can cause cancer.
7. The radioactive isotopes strontium-90 can enter the body through plants, fruits, flowers, cereals, milk, etc. and cause diseases like bone cancer, leukemia.

A peep into the past

Chernobyl disaster : On 26th April 1986 the graphite reactor in the Chernobyl atomic power plant exploded, and suddenly the radioactive isotopes and radiation came out. Due to this episode radioactive isotopes entered the human body through water and land and caused genetic disorders. These got carried further into the next generation. Thyroid disorders increased in children as well as adults. As a result, the incidence of throat diseases is greater there than in other places.

Some chemical substances in day to day life.

The food that we eat, objects like clothes, utensils, watches, medicines and other objects are made from various kinds of matter. These affect our health directly or indirectly. Let us learn about some such substances.



Can you tell?

1. A sweets shop looks attractive because of the colorful sweets displayed there. Which colours are used in these substances?
2. A doctor gives you medicines when you fall ill. What are the medicines made from?

Food colours and essences

Food colours are mixed in most soft drinks and foodstuffs available in the market. These food colours are in the form of powders, gels and pastes. Food colours are used in domestic as well as commercial products. Certain colours and essences are added to ice cream, ice candies, sauce, fruit juices, cold drinks, pickles, jams and jelly. Food colors are often found to be added to packaged meat (chicken, mutton), chilli powder, turmeric, sweets and other similar substances so as to give them a good colour.



14.2 Colourful eatables

Harmful effects of artificial food colours

1. Food colours added to pickles, jam and sauce contain small quantities of lead and mercury. These can be harmful for those who consume these products on a regular basis.
2. Diseases like ADHD (Attention Deficit Hyperactivity Disorder) can affect children due to excessive consumption of foods with added food colours.



Always remember

Food colours are natural as well as artificial. The food colours prepared from seeds, beetroot, flowers and fruit concentrate are natural. Tetrazene, sunset yellow are artificial food colours used extensively. However, over-consumption of artificial food colours can be detrimental to health. Therefore, usage of natural food colours is always good.

Dye

The coloured substance which on applying to an article, imparts that colour to the article, is called a dye. Generally, a dye is soluble in water and insoluble in oil. Often a mordant has to be used to fix the colour after dyeing a cloth.

Plants are the main source of colour for preparing a natural dye. Roots, leaves, flowers, bark, fruits, seeds, fungus and pistil are used for making dyes. In Kashmir a very good dye is made from saffron, which is used to dye fibres from which saris, shawls and dresses are made. These are very costly. Many people are engaged in this occupation as their means of earning a livelihood. The use of henna leaves to colour hair is safe for health.

William Henry Perkin invented an artificial dye in 1856. Artificial dyes are classified into many types on the basis of chemical properties and solubility. Petroleum products and minerals are used in these dyes.

Uses

1. They are used for colouring cloth and hair.
2. Fluorescent colours are used to make street boards that are visible at night.
3. Dyes are used to polish leather shoes, purses and chappals.

Adverse effects

1. Dyeing hair can have adverse effects like hair fall, damage to hair texture, burning of skin, adverse effect on eyes, etc.
2. Lipstick contains a dye named carmine. It does not affect lips but causes stomach disorders.
3. Excessive use of plants for making natural dyes results in deterioration of the environment.

Artificial colours



Can you tell?

1. What problems do you get after playing colours on Rang Panchami? Why?
2. Which colors will you use to prevent the occurrence of these problems?
3. What problem do you have on painting the house and furniture?

We regularly use artificial colours on Rang Panchami, decorating the house by painting. The red color used on Rang Panchami is very dangerous. It contains a high proportion of mercury in it. This poses risks like blindness, skin cancer, asthma, itching of the skin, permanent blocking of sweat pores etc. Therefore, it is necessary that artificial colours are used cautiously.



14.3 Harmful effects of artificial colours



Find out

Find out the hazardous chemicals present in the artificial colours and their harmful effects.



Try this

Prepare colours for Rang Panchami from natural resources such as beet root, flowers of flame of forest, spinach, flame tree (gulmohar) and protect your health by using these.

Deodorant

Body odour is caused by the bacterial decomposition of the sweat. A deodorant is used to prevent this odour. Everybody likes a fragrant deodorant to remain fresh the whole day. School children use deo on a large scale. This large scale use of deo in adolescent is a result of the advertisements shown on television. Deodorants contain parabens (methyl, ethyl, propyl, benzyl and butyl) and also alcohol in large proportions. Aluminium compounds and silica are also used.

1. Ordinary deo – It contains a smaller proportion of aluminium. It decreases the odour of the sweat.

2. Antiperspirant deo – This decreases the extent of sweating. It contains about 15% of aluminium chlorohydrate. It clogs the sweat pores on the skin.

3. Clinical deo – Some people sweat heavily and it has harmful effects on the skin. Clinical deo is meant for such people. It contains 20 to 25% aluminium. It is used during the night.

Harmful effects

1. Aluminium – Zirconium compounds are the most harmful chemicals in the deodorant. Disorders like headache, asthma, respiratory disorders, heart disease are likely to occur without our knowledge.

2. There is a possibility of various skin disorders and also skin cancer due to the aluminium chlorohydrates.

Teflon

Teflon is used for coating cooking utensils and industrial equipment to avoid sticking. It is the polymer of tetrafluoroethylene. Roy J. Plunkett discovered it in 1938. Its chemical name is polytetrafluoroethene ($(C_2F_4)_n$).



14.4 Teflon coating



Can you tell?

What is the property of Teflon because of which it is used in nonstick ware ?

Properties

1. The atmosphere and chemical substances have no effect on Teflon.
2. Neither water nor oil will stick to Teflon coated articles.
3. High temperatures do not affect Teflon as its melting point is 327°C .
4. Teflon coated articles are easy to clean.

Uses

1. Teflon is a poor conductor of electricity. Therefore, Teflon clad wires and parts are used in high technology electronics instruments.
2. It is used for making non-stick kitchenware.
3. The colored metal sheets of two-wheelers and four-wheelers are given a Teflon coating to protect them from damage due to high temperature and rain.

Powder coating : Powder coating is a method of applying a layer harder than paint on the surface of an iron object to prevent rusting. In this method, a polymer resin, a pigment and some other ingredients are melt mixed, cooled and ground into a uniform powder. This powder is sprayed on the polished metal surface by electrostatic spray deposition (ESD). In this method, the particles of the powder are given an electrostatic charge due to which a uniform layer of the powder sticks to the metal surface. Then the object is heated in the oven along with the coating. A chemical reaction occurs in the layer, resulting in the formation of long cross-linked polymeric chains. This powder coating is highly durable, hard and attractive. Powder coating can be done on plastic and medium density fibre (MDF) board in day to day use as well.

Anodizing : A protective layer is formed naturally on the surface of aluminium metal by reaction with oxygen in air. In the anodizing process, this layer can be made of the desired thickness. Anodizing is done by electrolysis. Dilute acid is taken in the electrolytic cell and the aluminium article is dipped in it as the anode. When an electric current is passed hydrogen gas is released at the cathode and oxygen gas at the anode. A reaction with oxygen occurs and a layer of hydrated aluminium oxide is formed on the anode, i.e. the iron article..This layer can be made attractive by adding colour in the cell during electrolysis. We use anodized cooking utensils like griddles and cookers. Why?

Ceramic : Ceramic is a heat resistant substance formed by kneading an inorganic substance in water and then shaping it and hardening it by heating. Pots made by a potter, Mangalore roofing tiles, construction bricks, pottery, terracotta articles are some examples of common ceramic articles that we see around.



This is how a ceramic article is made

When clay is kneaded in water, shaped and then fired in a kiln at a temperature of 1000 to 1150°C, a porous ceramic is formed. To overcome the porosity the fired object is covered with finely ground glass powder suspended in water (glaze) and is then fired again. As a result, the surface of the ceramic becomes shiny and its porosity disappears



14.5 Ceramics

Porcelain : This is a hard, translucent and white coloured ceramic. It is made by using the white clay called kaolin, found in China. Glass, granite and the mineral feldspar is mixed with kaolin and kneaded with water. The resulting mixture is shaped and fired in a kiln at a temperature of 1200 to 1450 °C. On firing again after glazing, beautiful articles of porcelain are obtained. Which porcelain vessels are used in the laboratory?

Bone china – Bone china is made by adding some ash of animal bones in the mixture of china clay, feldspar and fine silica while making porcelain. This ceramic is harder than porcelain.

Advanced ceramics : Oxides like Alumina (Al_2O_3), Zirconia (ZrO_2), Silica (SiO_2) and some other compounds like silicon carbide (SiC), boron carbide (B_4C) are used instead of clay for making advanced ceramic. This ceramic requires a temperature of 1600 to 1800 °C and an oxygen free atmosphere for firing. This process is called sintering.

Ceramics can withstand high temperatures without decomposing. Ceramic is brittle, water resistant and an electrical insulator. Therefore, it is used in electrical instruments, for coating the interior of a kiln, the outer surfaces of ships and blades of jet engines. A certain type of ceramic tiles are fixed on the outer layer of a space shuttle. Some types of ceramics are used as superconductors.

Exercises

1. Fill in the blanks.

- The number of molecules of water of crystallization in washing soda is
- The chemical name of baking soda is
- is used in treatment of hyperthyroidism.
- The chemical name of Teflon is

2. Match the pairs

Group A Group B

- | | |
|---------------------|----------------------------|
| 1. Saturated brine | a. sodium metal freed |
| 2. Fused salt | b. basic salt |
| 3. CaOCl_2 | c. crystallization of salt |
| 4. NaHCO_3 | d. oxidation of colour |

3. Write answers to the following

- What is meant by radioactivity?
- When is the nucleus said to be unstable?
- Which diseases are caused by artificial food colours?
- Where in the industrial field is radioactivity used?
- Write down properties of teflon.
- What type of colours will you use to celebrate ecofriendly Rang Panchami? Why?
- Why has the use of methods like Teflon coating become more common?

4. Give scientific explanation

- Bleaching powder has the odour of chlorine.
- The hard water of a well becomes soft on adding washing soda to it.
- Soap forms a precipitate in hard water.
- The particles of powder are given an electric charge while spraying them to form the powder coating.

- The aluminium article is used as an anode in the anodising process.
- When the radiation coming out from certain radioactive substance is passed through an electric field, marks are found at three places on the photographic plate placed in its path.
- A certain type of ceramic tiles are fixed on the outer layer of a space shuttle.

5. Write answers to the following

- Write about artificial food colours, the substances used in them and their harmful effects.
- What is meant by water of crystallization? Give examples of salts with water of crystallization, and their uses.
- Write briefly about the three methods of electrolysis of sodium chloride.

6. Write the uses.

- Anodizing
- Powder coating
- Radioactive substances
- Ceramic

7. Write the harmful effects

- Artificial dye
- Artificial food colour
- Radioactive substances
- Deodorant

8. Write the chemical formula

- Bleaching powder, common salt, baking soda, washing soda

9. Explain what you see in the following picture



Project : Visit the places where powder coating, Teflon coating is done. Get information about the process and present it in the class.



15. Life Processes in Living Organisms



- **Transportation in Plants**
- **Excretion: Plants, Animals and Humans.**
- **Co-ordination: Plants and Humans**



Can you recall? How do the digestive system and respiratory system work?

We have studied how digested food or oxygen inhaled by lungs is transported to every cell of the human body. The farmer also tries to transport the water from wells or dams through a main channel to every plant. The food absorbed by the digestive system is converted into energy. This energy and oxygen are both transported via blood throughout the body.

Transportation

By the process of transportation, a substance either synthesised or absorbed in one part of the body reaches another.

Transportation in plants



Discuss

1. Why do we eat fruits and vegetables? Do the plants also need minerals like we do?
2. From where do the plants get inorganic substances other than carbon dioxide and oxygen?

Most animals move from place to place but plants do not. There are many dead cells in the plant body. They need less energy as compared to animals. Plants need inorganic substances like nitrogen, phosphorus, magnesium, manganese, sodium, etc. Soil is the nearest and richest source of these substances. Roots of plants absorb these substances from the soil and transport them. There are specific types of tissues to perform this function. The xylem conducts the water whereas the phloem conducts the food. All parts of the plant are connected with these conducting tissues.



Use your brain power !

Which types of plant tissues are xylem and phloem?

Transportation of water in plants :



Try this

Root pressure

Take a small plant like balsam or tuberose with its roots intact. Wash and clean its roots. As shown in the fig. 15.1, keep it in the water containing a stain like safranin or eosin. Observe the stem and the veins of the leaves after 2 – 3 hours.

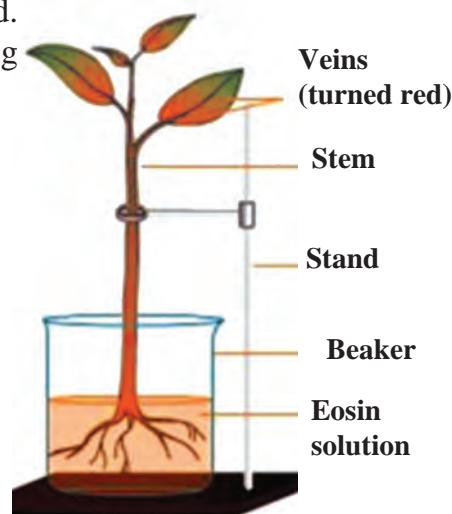

15.1 Root pressure



Observe

Take a transverse section of the stem of a plant and observe the stained xylem under a compound microscope.

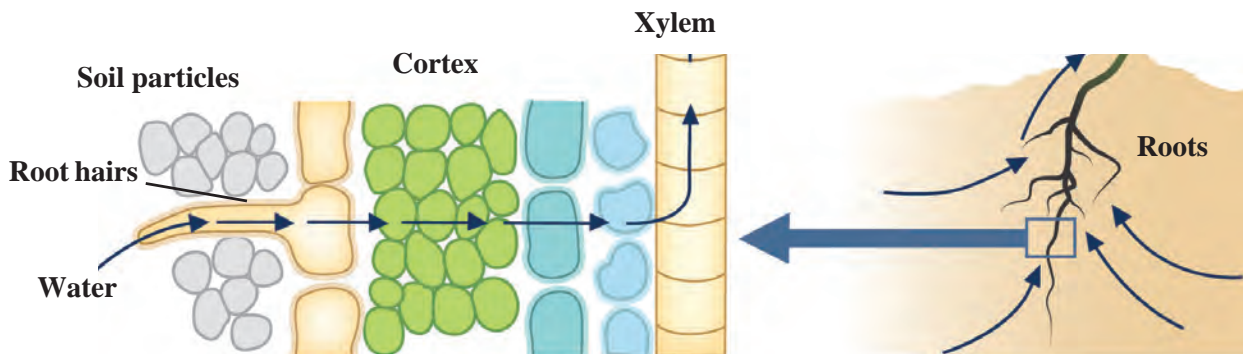

15.2 Absorption with the help of roots

Root cells are in contact with water and minerals in the soil. Water and minerals enter the cells on the root surface due to differences in concentration. As a result, these cells become turgid. These turgid cells exert pressure on the adjacent cells. This is called 'root pressure'. Under the effect of this pressure, water and minerals reach the xylem of the roots and to reduce this difference in concentration they are continuously pushed forward. As a result of this continuous movement, a water column is formed, which is continuously pushed ahead. This pressure is sufficient to lift the water up in shrubs, small plants and small trees.

Transpiration pull



Can you recall?

Previously you have performed the activity of observing a branch covered in a plastic bag. What did you observe in that activity?

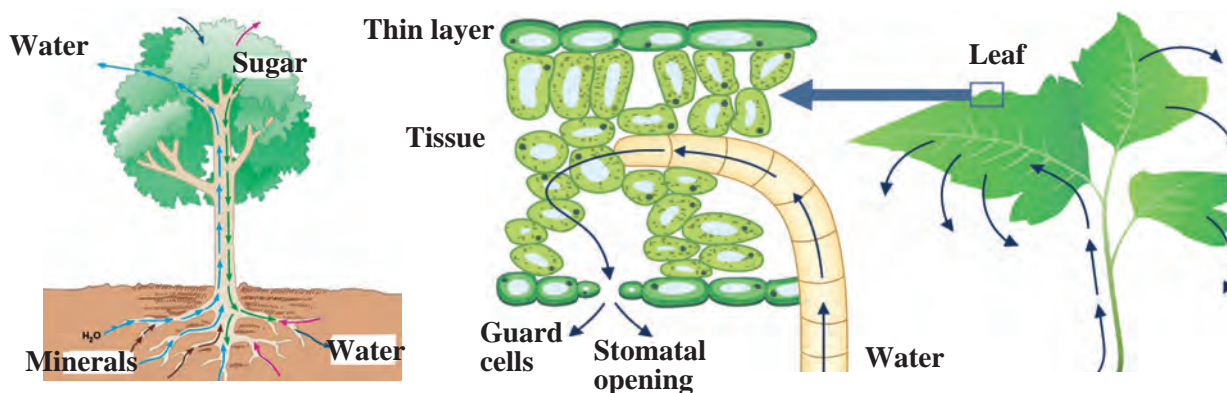

15.3 Transpiration through Leaves

Plants give out water in the form of vapour through the stomata on their leaves. Two cells called guard cells are present around the stomata. These cells control the opening and closing of stomata. Transpiration occurs through these stomata. Water is released into the atmosphere by leaves through the process of evaporation. As a result, water level in the epidermal layer of the leaf decreases. Water is brought up to the leaves through the xylem so as to compensate for the lost water. Transpiration helps in absorption of water and minerals and distribution to all parts of the plant whereas root pressure performs the important role of pushing the water up during the night time.



Do you know?

The oak tree releases about 1,51,000 litres of water into the air by the process of transpiration in one year whereas a maize crop in an area of one acre gives out about 11,400 to 15,100 litres of water per day.



Transportation of food and other substances in plants :

The food produced in leaves is transported to each cell in the plant body. Excess food, except amino acids, is stored in roots, fruits and seeds. This process is called ‘translocation’ of materials. It is carried out in both the upward and the downward directions by the phloem. Translocation of materials is not a simple physical process; it requires energy. This energy is obtained from ATP.

Whenever food material like sucrose is transported towards a part of a plant via the phloem with the help of ATP, the water concentration decreases in that part. As a result, water enters the cell by the process of diffusion. The pressure on the cell wall increases due to the increase in cellular contents. Due to the increased pressure, food is pushed into the neighbouring cells where the pressure is low. This process helps the phloem to transport the materials as per the need of the plant. During flowering season, the sugar stored in roots or stem is transported towards the floral buds to make them open and blossom.

Excretion



Think about it

At least a small quantity of garbage or waste is produced every day in each house. What will happen if you keep this garbage for many days in your house?

Many harmful and waste substances like urea, uric acid, ammonia, etc. are produced in living organisms. If these substances accumulate in the body or are retained in the body for long, it can lead to serious harm or even death. Hence, it is necessary to remove such harmful and waste substances from the body. Different organisms have different methods of doing this. Removal of waste or harmful substances from the body is called excretion. In unicellular organisms, waste materials are directly eliminated across the cell surface whereas the process of excretion in multicellular organisms is complex.



Always remember

Retention of unwanted and harmful substances in the body is dangerous. Hence, just as the process of excretion occurs in living organisms, similarly, proper disposal of the garbage produced in our locality and home is also necessary. This will help you lead a healthy life.

Excretion in plants



Can you tell? Why does this happen?

1. Leaves of plants fall off in a particular season.
2. Fruits, flowers fall off after a certain period of time.
3. Substances like resin, gum, etc. are given out of the plant body.

Excretion is a simpler process in plants than in animals. There is no special organ or system for excretion in plants. Gaseous substances are given out by diffusion. Most of the waste substances of plants are stored in vacuoles of leaf-cells and in flowers, fruits and the bark of the stem. After some time these parts fall off. Some other waste materials are stored in old and worn xylem in the form of resin and gum. Some waste materials are also given out through roots into the surrounding soil.



15.4 Leaf fall



Observe and find out.

Observe your mother while she cuts elephant's foot (*Amorphophallus*) or arum leaves. Your hands may also begin to itch if you try to cut those leaves. Why does this happen? Try to find out. Ask your mother what she does to prevent the itching.

In some plants, waste materials are present in the form of crystals of calcium oxalate. They are called raphides. As they are needle-shaped, they prickle and cause irritation of the skin.

Some waste materials of plants are useful to humans, for example, gum, resin, latex of rubber, etc.



15.5 Gum and latex

Excretion in human beings



Can you tell?

1. Which waste materials are produced in our body through metabolic activities?
2. How does the process of excretion take place in humans?

There are different organ systems in the human body to bring about the different life processes, such as the digestive system for digestion of food, respiratory system for respiration, etc. The process of digestion leading to energy production is an important process of our body. Various waste materials are formed during this process. Removal of these wastes from the body is very important and it is the **excretory system** that carries out this function.

The human excretory system consists of a pair of kidneys, a pair of ureters, the urinary bladder and the urethra. Urine is formed by the kidneys by separating the waste and unwanted excess substances from the blood.

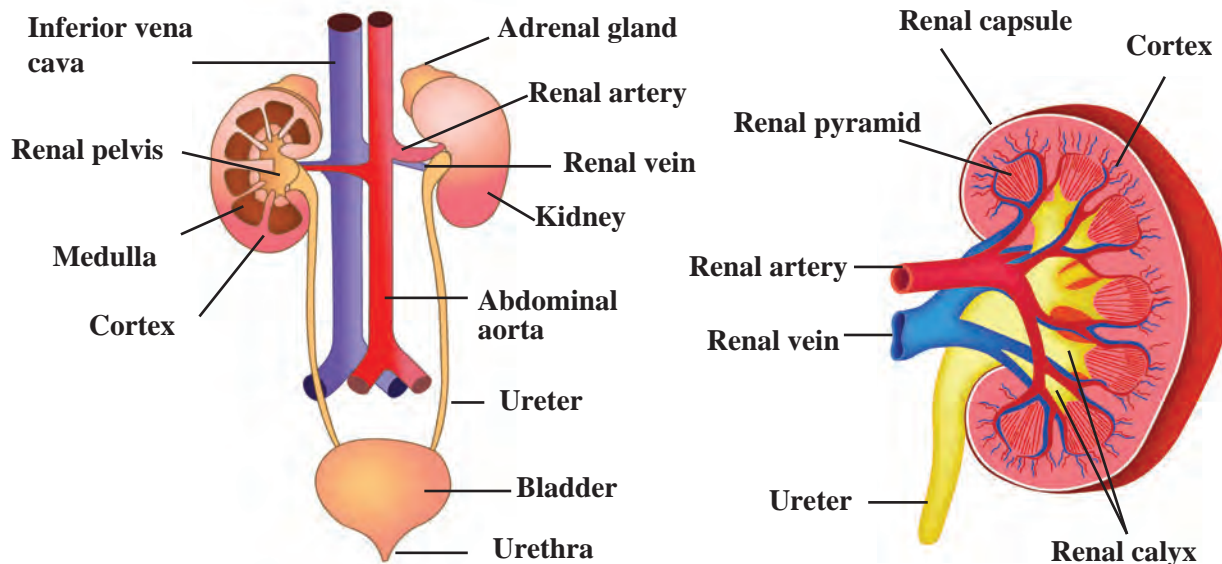

15.6 Excretory system and kidneys

The two bean-shaped kidneys are situated one on either side of the vertebral column, on the posterior side of abdomen. The functional unit of the kidney that performs the basic function of filtration is called a nephron. Each nephron has a cup-like, thin-walled upper part called the Bowman's capsule. The network of capillaries in it is called a glomerulus. The urea produced in the liver comes into the blood. When the urea-containing blood comes into the glomerulus, it is filtered through its capillaries and urea and other similar substances are separated from it.

Water molecules and small molecules of some other substances can cross the semipermeable membrane of Bowman's capsule. The solution accumulated in the cavity of Bowman's capsule passes into the tubular part of the nephron. Here, molecules of water and some other useful substances are reabsorbed into the blood. Urine is formed from the remaining solution which is full of waste materials. The urine is carried by the ureters and stored in the urinary bladder. Afterwards, urine is given out through the urethra. The urinary bladder is muscular and it is under the control of nerves. Hence, we are able to keep a control on urination. Though the kidneys are the main organs of excretion in human beings, the skin and lungs also help in the process of excretion.

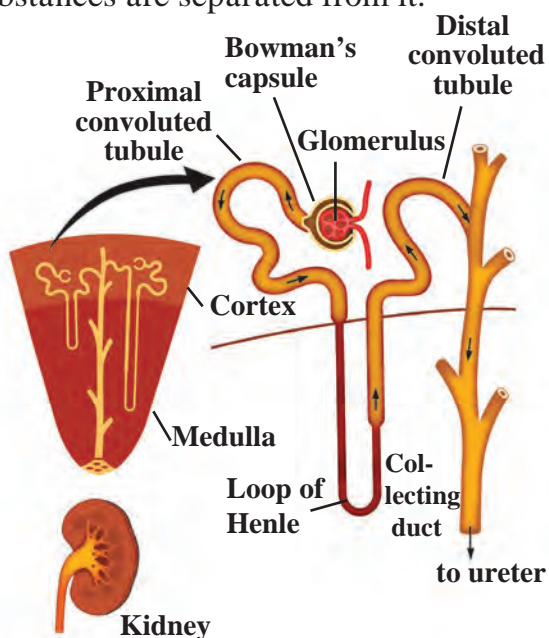

15.7 Nephron

The right kidney is in a slightly lower position than the left. Each kidney has approximately 10 lakh nephrons. The approximately 5 litre of blood which is present in a normal healthy person's body is filtered by the kidneys about 400 times every day. Thus, every day, the kidneys filter about 190 litres of blood from which about 1 to 1.9 litres of urine is formed. The remaining liquid is reabsorbed.

Dialysis

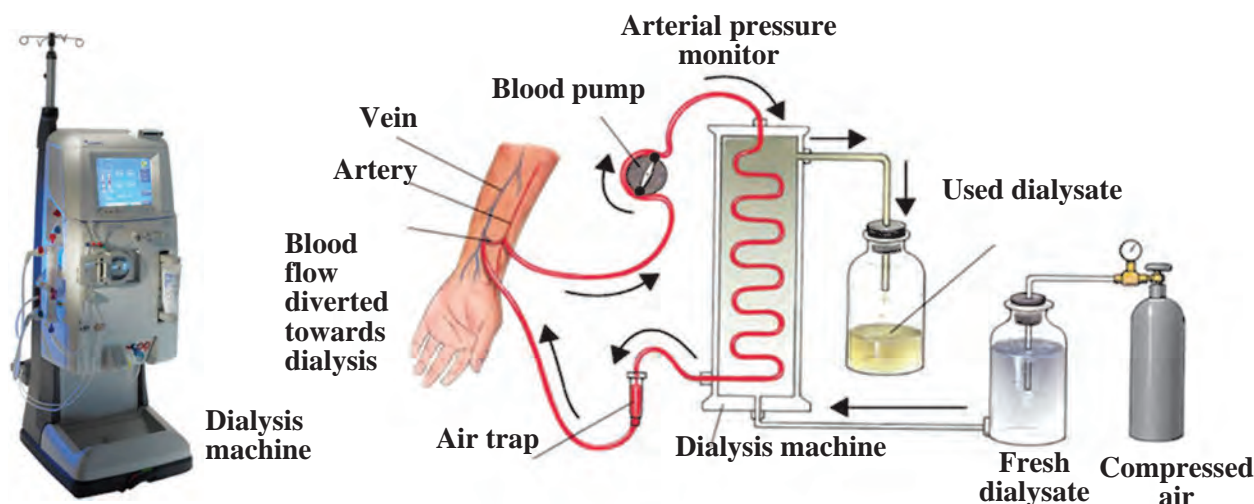

15.8 Dialysis of blood

The efficiency of kidneys can be adversely affected by injury, infection or decreased blood supply. In case this happens, an excess of toxic substances accumulates in the body and it can lead to death. If kidneys fail, nitrogenous wastes are separated from the blood with the help of a man-made machine. The process of separating the nitrogenous waste from blood with the help of this machine is called dialysis. About 500 ml of blood is sent at one time through this machine. Purified blood is reinfused into the body of the patient.



Use your brain power !

1. As compared to the monsoons and winter a very small quantity of urine is produced in the summer season. Why is it so?
2. In adults, the process of urination is under their control but not in infants. Why is it so?

Co-ordination



Think about it

1. Sometimes, while eating we bite our own finger or tongue by mistake.
2. Sometimes, we choke while eating in a hurry.

Several different organ systems function in multicellular organisms. Their life goes on smoothly if there is co-ordination between the different organ systems or organs and the stimuli in the surrounding. Depending upon this, we can say that systematic regulation of different processes can be called control and bringing about the different processes in the proper sequence can be called co-ordination.

If any activity in the body is to be completed successfully, proper co-ordination between different systems and organs participating at different steps of that activity is necessary. If due to lack of co-ordination or some other factor, there is confusion at any step the activity may not get completed. There should not be any randomness at any step. There needs to be proper co-ordination between internal activities of the body resulting from various factors like body temperature, water-level, enzyme-level, etc. or stimuli arising in the surrounding environment. Proper co-ordination between various systems of an organism helps to maintain a state of equilibrium called 'homeostasis' which is necessary for the optimal efficiency of the body.

Co-ordination in plants

Plants do not have systems like the nervous system or muscular system of animals. Then, how do plants bring about movements? In plants, movements are mainly in the form of responses given to the stimuli.



Observe

Observe the following figures carefully.

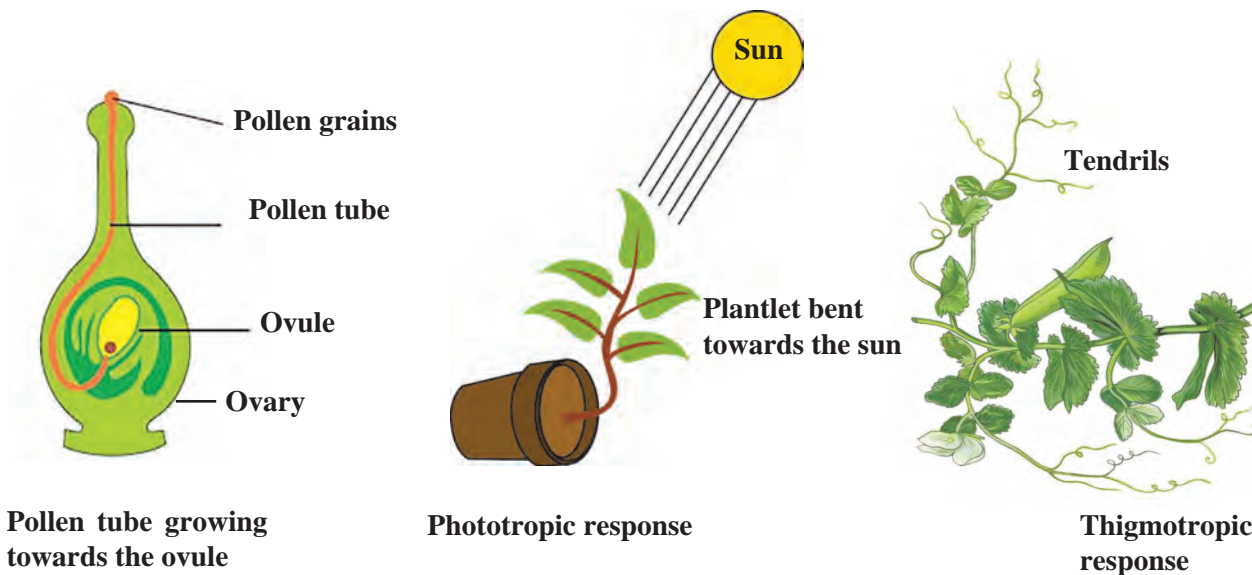

Pollen tube growing towards the ovule

Phototropic response

Thigmotropic response

15.9 Co-ordination in plants

Movement or growth of any part of the plant in response to an external stimulus is called 'tropism' or 'tropic movement'.

The shoot system of any plant responds to the light stimulus i.e. it grows towards the source of light. The movement shown by plants towards the source of light is called 'Phototropic movement'.

The root system of plants responds to stimuli like gravitation and water. These responses are called 'gravitropic movement' and 'hydrotropic movement' respectively.

Movement shown by plants in response to specific chemicals is called 'chemotropic movement'. For example, the growth of the pollen tube towards the ovule.

All the above-mentioned movements of plants are related with growth; hence all such movements are collectively called 'growth relevant movements'.

Do you know?

- * Tendrils of climbers are sensitive to touch.
- * A hormone called auxin produced in the apical part of the shoot helps in enlargement of cells.
- * Hormones like gibberellins help in stem elongation and cytokinins help in cell division.
- * The hormone, abscisic acid, is effective in prevention and retardation of growth, leaf wilting, etc.

**Observe**

Observe the pictures carefully and think about them.



Touch-me-not



Venus fly trap



Lotus



Balsam

15.10 Various plants

On careful observation it is seen that in plants like touch-me-not (*Mimosa*), movement also occurs at the places other than where it has been touched. Hence, we can infer that the information about the touch must have been relayed within the plant from one place to another. Plants use electro-chemical impulses for transfer of information from one place to another. Plant cells change their shape by increasing or decreasing their water content and thereby bring about the movements of plants.

Some specific movements of the plants do not lead to the plant's growth. Such movements are called 'growth-irrelevant movements'. As a response to changes in the surroundings, plant hormones bring about various movements in plants.

**Do you know?**

In the plant called Venus fly trap, there is a trap that appears and smells like flowers and deceives insects. When an insect visits that flower-like trap, the trap closes up and the trapped insect is digested by the plant.

The lotus flower opens during daytime while that of the tuberose (*Polyanthus*) opens at night.

Fibrils present on the leaves of the insectivorous plant *Drosera*, bend inwards as soon as an insect lands on the leaves and surround the insect from all sides.

In Balsam, the ripened fruit dehisces (bursts-open) at the right time to disperse the seeds.

Co-ordination in human being**Observe**

As you watch the match being played on your school ground, you will see the control and co-ordination among the movements of the players. Make a list of all such different actions.

Different processes go on simultaneously in the human body. All these process need to be efficiently and effectively conrolled and co-ordinated. This is done with the help of two systems.

A. Nervous control : Humans can respond to changes in their surroundings due to nervous control. Impulses are generated in the human body, in accordance with changes in the surroundings. Nervous control plays the important role of empowering the body cells with ability to respond to these impulses. This ability depends upon the complexity of organization in the organism’s body structure. Unicellular animals like the amoeba do not have a nervous system which produces such impulses and responses. However, multicellular animals like humans, have a nervous system to respond to the stimuli. Control and co-ordination is brought about with the help of a special type of cells called nerve cells or neurons.

Neurons (Nerve cells) : Special types of cells which conduct impulses from one place to another in the body are called neurons. Neurons are the structural and functional units of the nervous system. Nerve cells, the largest cells in the human the body, may measure up to a few metres in length. Nerve cells have the ability to generate and conduct electro-chemical impulses. The cells that support the nerve cells and help in their functioning are called neuroglia. Nerve cells and neuroglial cells together form the nerves.

All the information about our surroundings is collected by the ends or dendrites of the neuron. The chemical process begins at those ends and electric impulses are generated which are conducted from the dendrites to the cell body, from the cell body to the axon and from the axon to its terminal. These impulses are then to be transferred from this nerve cell to the next. Now the impulse that reaches the terminal of an axon, stimulates the nerve cell to secrete certain chemicals. These chemicals pass through a minute space, called the synapse, between two adjacent neurons and generate the impulse in the dendrites of next neuron. In this way, impulses are conducted in the body and these impulses are finally conveyed by nerve cells to muscle cells or glands.

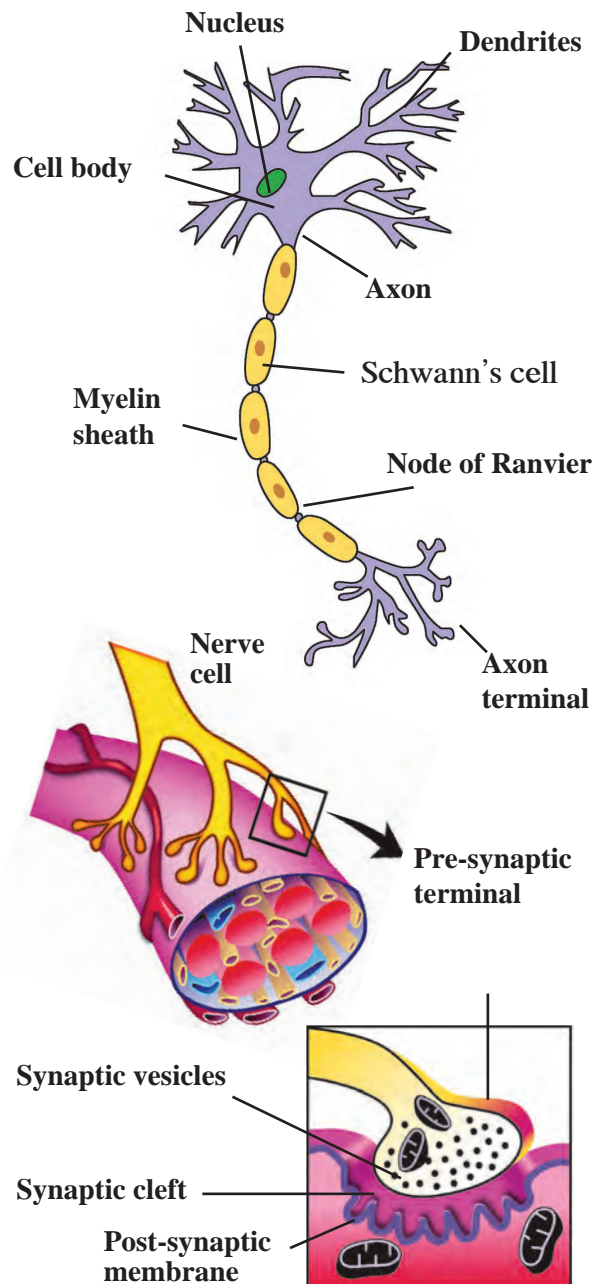

15.11 Nerve cell and neuro-muscular junction

When an action or movement is to be brought about in the body, the work of the muscular tissue comes last in the sequence. Movement of muscle cells is essential to bring about any activity. When cells contract to change their shape, movement occurs at cellular level. Muscle cells have the ability to change their shape due to a special type of protein. Besides, due to these same proteins, cells become able to respond to electrical impulses of nerves.

Thus, we can say that the nervous system consists of a well-organized network of nerves which can conduct information in the form of electrical impulses from one part of the body to other.



Can you tell?

1. Which are the sensory organs of an organism? What is their function?
2. Where are the gustatory and olfactory nerves to be found?
3. Collect information about the function of all the above mentioned parts and present it in the class.

Types of nerve cells/neurons

According to their function, nerve cells are classified into three types.

1. **Sensory neurons** : Sensory neurons conduct impulses from sensory organs to the brain and the spinal cord.
2. **Motor neurons** : Motor neurons conduct impulses from the brain or spinal cord to effector organs like muscles or glands.
3. **Association neurons** : Association neurons perform the function of integration in the nervous system.

The human nervous system

The human nervous system is divided into the following three parts.

1. **Central nervous system**
2. **Peripheral nervous system**
3. **Autonomic nervous system**

Central Nervous System or CNS

The central nervous system consists of the **brain** and **spinal cord**.

The organization of the brain is extremely delicate and highly evolved. The brain is the main controlling part of the nervous system and it is safely located in the cranial cavity. The spinal cord is protected by the vertebral column. In the space between the delicate central nervous system and its bony covering are the protective layers called the **meninges**. Cavities present in various parts of the brain are called '**ventricles**' whereas the long tubular cavity of the spinal cord is called the '**central canal**'. The ventricles, central canal and spaces between the meninges are filled with cerebro-spinal fluid. This fluid supplies nutrients to the central nervous system and protects it from shock.

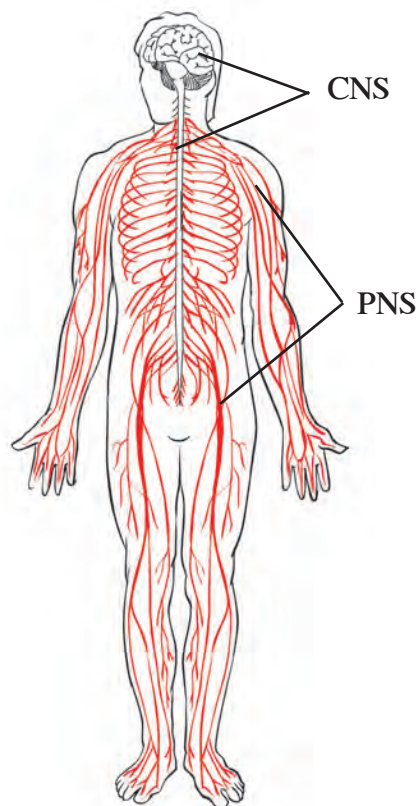

15.12 Human nervous system

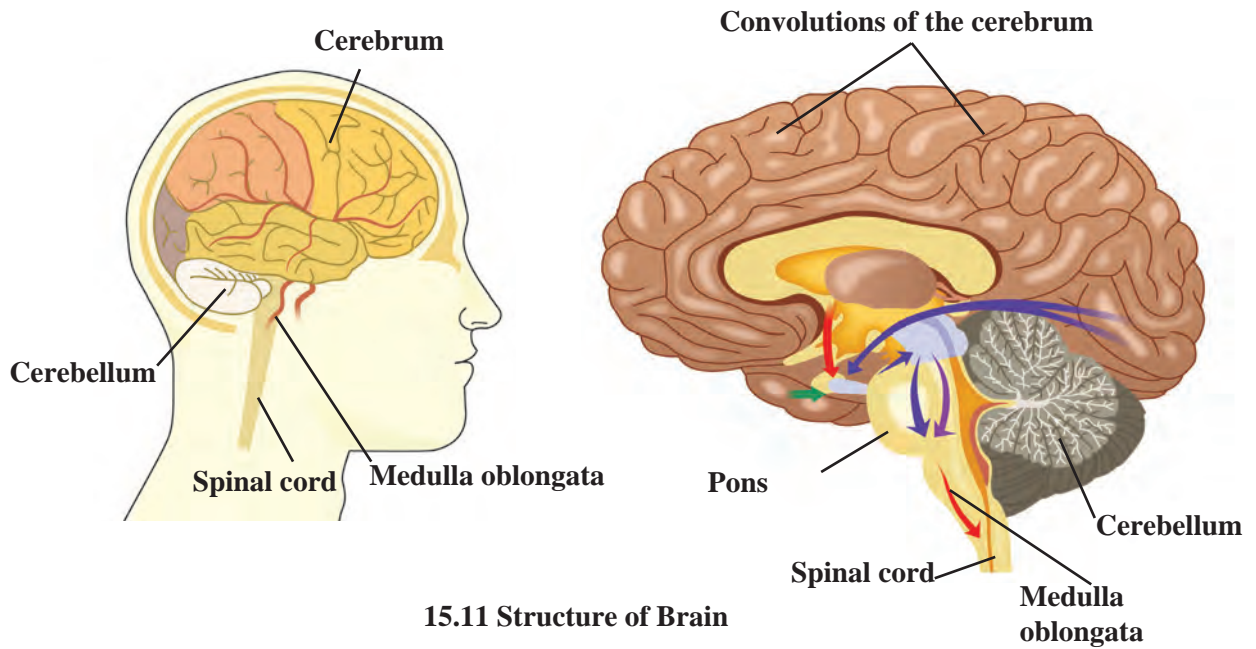

15.11 Structure of Brain

The brain of an adult human weighs about 1300 – 1400 grams and consists of approximately 100 billion neurons.

The left side of our brain controls the right side of our body and right side of our brain controls left side of the body. In addition, the left side of the brain controls our speech and conversation, writing, logical thinking, etc. whereas the right side controls artistic abilities.

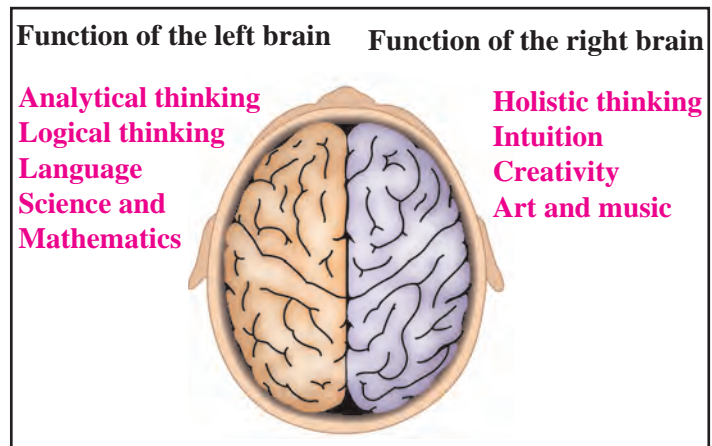

15.14 Left and right sides of brain

Cerebrum :

This is largest part of our brain and consists of two cerebral hemispheres. These hemispheres are joined with each other with the help of tough fibres and **nerve tracts**. The cerebrum occupies two-thirds of the brain. Hence, it is also called the large brain. Its surface has deep, irregular ridges and grooves which are called convolutions. Convolution increases the surface area of the cerebrum and therefore a large number of nerve cells can be accommodated.

Cerebellum :

This is the smaller part of the brain situated below the cerebrum at the back of the cranial cavity. Its surface shows shallow grooves instead of deep convolutions.

Medulla oblongata :

This is the hind-most part of brain. There are two triangular swollen structures called pyramids on the upper side of medulla oblongata. The medulla oblongata continues downwards as the spinal cord.

**Think about it**

An injury to the medulla oblongata can lead to death. Why?

Spinal cord

The spinal cord is a part of the central nervous system and it is held within the vertebral column. It is slightly thick but gradually tapers towards the end. There is a thread-like fibrous structure at its end. It is called the Filum terminale.

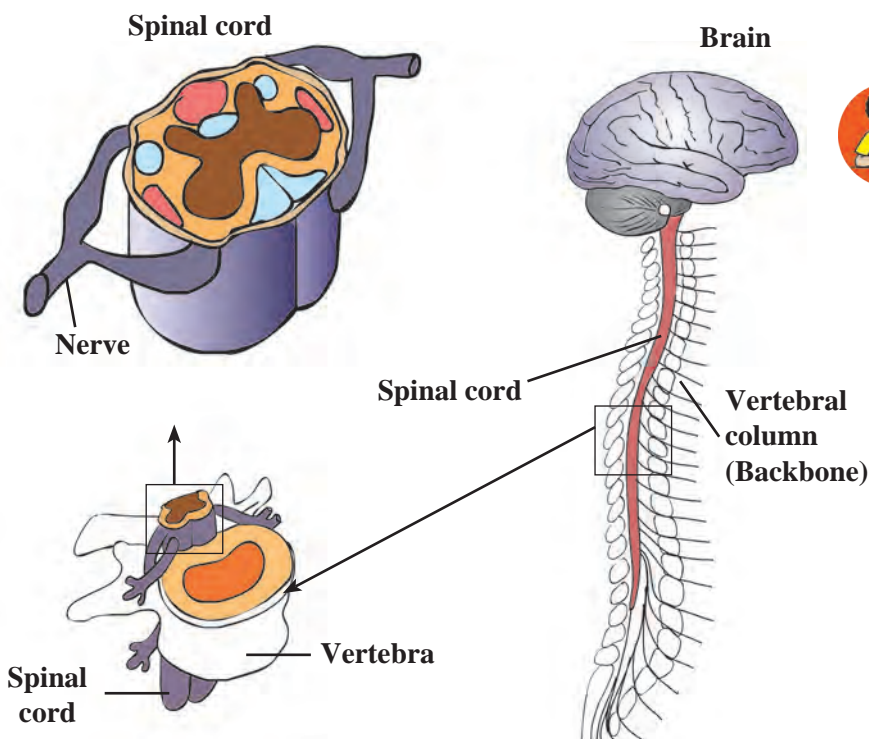
**Find out.**

You may have seen how a drunken person struggles to maintain his body balance. An excess of alcohol in the body causes one to lose control over it. Why does this happen? Find out the reason with the help of the internet.

15.15 Brain and spinal cord

Brain: different regions and functions

Parts of the Brain	Functions
Cerebrum	Control of voluntary movements, concentration, planning, decision-making, memory, intelligence, and intellectual activities.
Cerebellum	1. Co-ordination of voluntary movements. 2. Maintaining the body's balance.
Medulla oblongata	Control of involuntary activities like the beating of the heart, blood circulation, breathing, sneezing, coughing, salivation, etc.
Spinal cord	1. Conduction of impulses from the skin towards the brain. 2. Conduction of impulses from brain to muscles and glands. 3. Functions as centre of co-ordination of reflex actions.

Peripheral nervous system

The peripheral nervous system consists of the nerves originating from the central nervous system. These nerves connect the central nervous system with all parts of the body. They are of two types.

A. Cranial nerves

Nerves originating from the brain are called cranial nerves. They are associated with various parts in the head, thorax and abdomen. There are 12 pairs of cranial nerves.

B. Spinal nerves

Nerves originating from the spinal cord are called spinal nerves. These are associated with arms, legs, skin and some other parts of the body. There are 31 pairs of spinal nerves.

3. Autonomic nervous system

The autonomous nervous system consists of the nerves of involuntary organs like the heart, lungs, stomach, etc. It is not under the control of our will.

Reflex action

An immediate and involuntary response given to a stimulus from the environment is called a reflex action. Sometimes we react to an incident without any thinking on our part or control over the reaction. This is a response given to a certain stimulus from the surroundings. In such situations, proper control and co-ordination is achieved even without intervention of the brain.

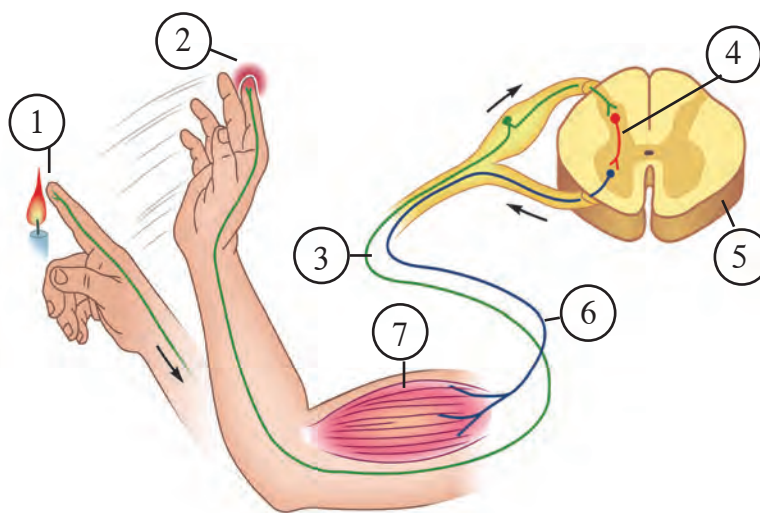

15.16 Reflex action

Observe the above figure carefully and as per the numbers in that figure, answer the following questions.

- What is happening at 1 and 2?
- Which nerve carried the impulse to the point marked 3? In which direction is it conducting the impulse?
- Which is the nerve shown by 4?
- Which is the organ marked as 5?
- At 6, which nerve is conducting the response impulse?
- At 7, where has the impulse reached? What is its effect?



Sketch and label the above figure.
Try to sketch any other example of a reflex action.

B. Chemical control

Control and co-ordination in our body is also brought about with the help of certain chemical substances called hormones. Hormones are secreted by **endocrine glands**. These glands are also called ductless glands. These glands do not have any arrangement of their own to either store or carry their secretions. Hence, as soon as hormones are produced, they are directly released into the blood circulation. Thus, though these endocrine glands are present at specific locations in our body, their secretions reach all parts of the body via blood.

Endocrine glands along with the nervous system are responsible for the control and co-ordination in our body. These two systems help each other to control and integrate the various activities of the body. A marked difference between these two systems is that nerve impulses are fast but short lived whereas the action of hormones is very slow but long lasting.

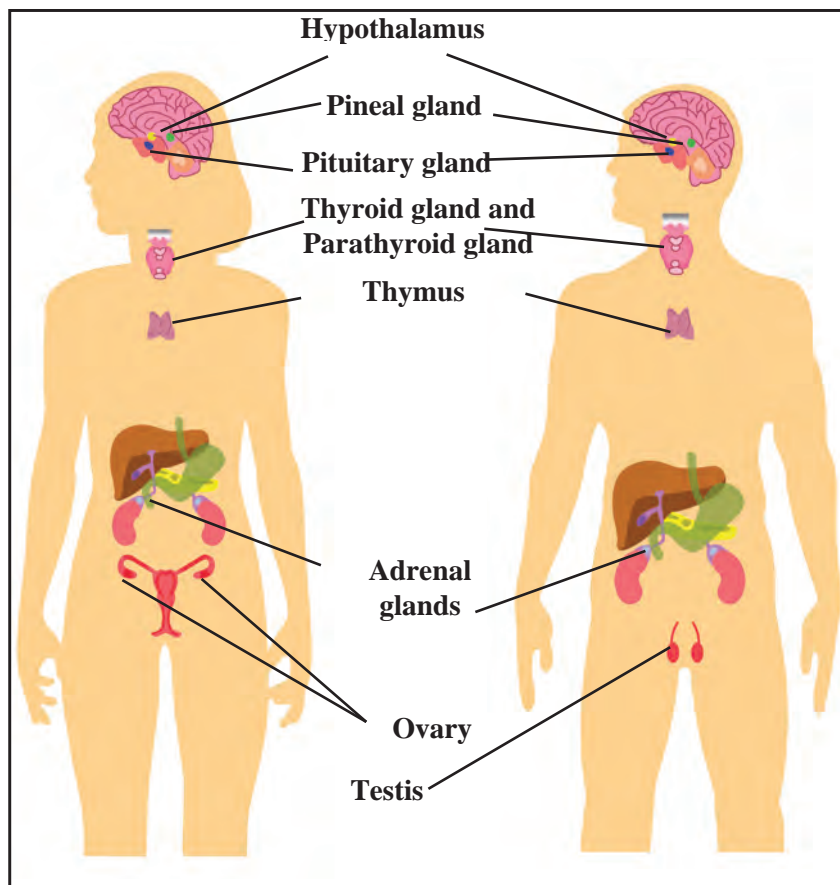

15.17 Endocrine glands

It is very important that hormones are secreted only in the required quantity and there is a special mechanism which controls the quantity and timing of hormone secretion. For example, whenever there is an increase in blood-glucose level, certain cells in the pancreas get stimulated and as a response, they release a greater quantity of insulin.



Using ICT :

Using the following websites and with the help of your teachers, prepare a power point presentation on the human excretory system and the structure of the human brain and present it in the classroom.

www.nationalgeographic.com/science/health-and-humanbody/humanbody

www.webmed.com/brain

www.livescience.com/humanbrain

Endocrine glands: Location and important functions

Glands	Location	Hormones	Functions
Hypothalamus	Above the pituitary gland, in the forebrain	Secretes the hormones which control the activity of the secretory cells of the pituitary gland	- Controls the pituitary gland
Pituitary	At the base of brain	Growth Hormone Adrenocorticotrophic hormone Thyroid stimulating hormone Prolactin Follicle stimulating hormone Luteinizing hormone Oxytocin Antidiuretic hormone	- Stimulates growth of bones - Stimulates adrenal gland - Stimulates thyroid gland - Stimulates milk production - Controls growth of gonads - Controls menstrual cycle and ovulation - Contracts uterus during parturition. - Regulates water-level in the body
Thyroid	Anterolateral sides of trachea in neck region	Thyroxine Calcitonin	- Controls growth of body and metabolic activities - Controls calcium metabolism and calcium level in blood
Parathyroid	Four glands behind thyroid gland	Parathormone	Controls metabolism of calcium and phosphorus
Pancreas	Behind the stomach. Four types of cells Alpha-cells (20%) Beta-cells (70%) Delta-cells (5%) P.P. cells or F-cells (5%)	Glucagon Insulin Somatostatin Pancreatic Polypeptide	- Stimulates liver to convert glycogen into glucose - Stimulates liver to convert excess blood-glucose into glycogen - Controls levels of insulin and glucagon - Controls movements of intestine and thereby glucose absorption - Controls secretion of pancreatic juice
Adrenal Gland	Anterior end of each kidney	Adrenaline and Nor-adrenaline Corticosteroid	-Controls behaviour during crisis and emotional situations - Stimulates heart and its conducting tissue and metabolic processes. Maintains balance of Na ⁺ and K ⁺ and stimulates metabolism
Ovary	On either side of uterus in women	Oestrogen Progesterone	-Stimulates growth of endometrium -Stimulates growth of secondary sexual characteristics in women -Prepares the endometrium for conception and maintains the pregnancy.
Testis	In scrotum	Testosterone	Stimulates growth of secondary sexual characteristics like beard, mustache, hoarse voice, etc. in men
Thymus	In thoracic cage, near the heart	Thymosin	Controls the cells which give rise to immunity



1. Match the pairs and explain.

‘A’	‘B’
1. Growth of pollen tube towards ovule 2. Growth of shoot system 3. Growth of root system 4. Growth towards water	a. Gravitropic movement b. Chemotropic movement c. Phototropic movement d. Growth-irrelevant movement e. Hydrotropic movement

2. Complete the paragraph.

The milk was on the stove. Rasika was engrossed watching television. She smelled something burning. She ran towards the kitchen. The milk was boiling over. She held the vessel with her bare hands but, screaming, she let it go at once. This activity was controlled by cells. Special ends of in these cells collected the information, from where it was transferred to the and then towards the terminal end of the The chemicals produced at the terminal end passed through the minute space i.e. In this way, were conducted in the body and the process of was completed by conducting the impulses from to
 (Nerve, muscle cell, impulse, dendrite, synapse, axon, reflex action, cell body)

3. Write notes on-

Root pressure, Transpiration, Nerve cell, Human brain, Reflex action

4. Name the hormones of the following endocrine glands and the function of each.

Pituitary, Thyroid, Adrenal, Thymus, Testis, Ovary.

5. Draw and label the diagrams.

Human endocrine glands, Human

brain, Nephron, Nerve cell, Human excretory system.

6. Answer the following.

- Explain chemical co-ordination in humans and give the names and functions of some hormones.
- Explain the difference between the excretory system of humans and plants.
- Explain co-ordination in plants with the help of suitable examples.

7. Explain in your own words with suitable examples.

- What is meant by co-ordination?
- How does excretion occur in human beings?
- How is excretion in plants useful to human beings?
- Describe the transportation system in plants.

Activity :

- Collect information about the evolution of the brain of vertebrates and present it in the classroom.
- Explain the functions of various endocrine glands by presenting an act like ‘Why I Am Important?’
- Collect the information to justify the statement ‘Human beings are intelligent and different from other animals’ and present it in the classroom.



16. Heredity and Variation



- **Inheritance** ➤ **Heredity: Characteristics and their appearance**
- **Mendel's laws of inheritance** ➤ **Diseases due to chromosomal aberrations**



Think about it

1. Do all the boys and girls of your class look alike?
2. Think about the following characteristics and note similarities and differences. (Teachers should help in this activity.)

Sr. No.	Personal characteristics	Own	Grandfather	Grandmother	Father	Mother
1	Colour of skin					
2	Shape of face (Round/Oblong)					
3	Height					
4	Colour of eyes					
5	Orientation of thumb					

Earlier, we have seen that there is great variation within every species in nature. In this chapter, we shall study the factors that give rise to these variations.

Inheritance

The branch of biology which studies the transfer of characteristics of organisms from one generation to the next, and genes in particular, is called 'genetics'.

New progeny is formed through the process of reproduction. Except for a few minor differences, the offspring shows great similarities with parents. Organisms produced by asexual reproduction show minor variations. However, offspring produced through sexual reproduction, show comparatively greater variations.



Observe

1. Carefully observe your classmate's earlobes.
2. Irrespective of all of us being humans, what difference do you notice in our skin colour?
3. All of you are in std. IX. Why then are some students tall and some short?

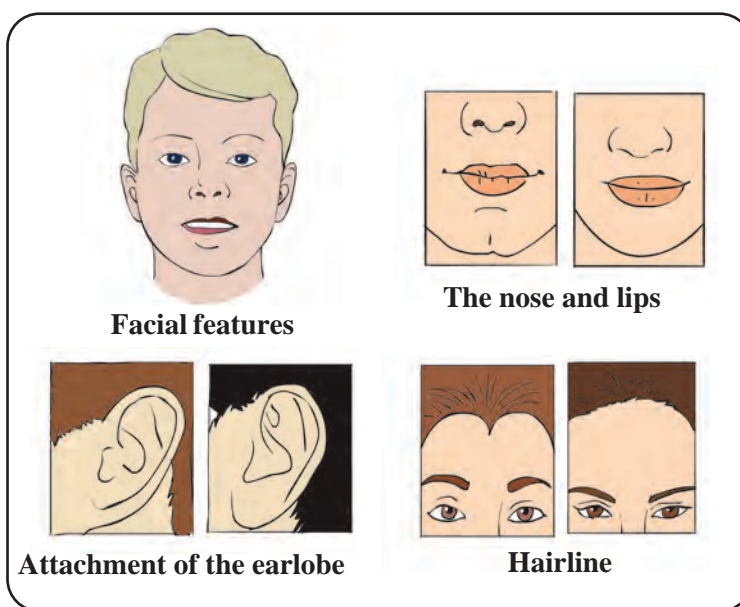

16.1 Some differences in facial features

Heredity :

Transfer of characteristics from parents to offspring is called heredity. It is due to heredity that puppies are similar to dogs, squabs are similar to pigeons and infants are similar to humans.

Inherited traits and expression of traits :



Can you tell?

How do specific traits or characteristics appear in organisms?

Though there are many similarities between parents and their offsprings there are some differences too. These similarities and differences are all the effect of heredity. Let us study the mechanism of heredity. Information necessary for protein synthesis in the cell is stored in DNA. The segment of DNA which contains all the information for synthesis of a particular protein is called a 'gene' for that protein. It is necessary to know the relationship of these proteins with the characteristics of organisms.

To understand the concept of heredity let us consider the characteristic 'plant height'. We know that there are growth hormones in plants. Increase in height of plants depends upon the quantity of growth hormones.

The quantity of growth hormones produced by a plant depends upon the efficiency of the concerned enzyme. Efficient enzymes produce a greater quantity of the hormone due to which the height of the plant increases. However, if the enzymes are less efficient, a smaller quantity of hormone is produced leading to a stunting of the plant.

Chromosomes

The structure in the nucleus of cells that carries the hereditary characteristics is called the chromosome. It is made up mainly of nucleic acids and proteins. During cell division chromosomes can be clearly seen under the compound microscope. 'Genes' which contain the information about hereditary characteristics in coded form are located on chromosomes. Each species has a specific number of chromosomes.

Each chromosome is made up of DNA and it appears dumbbell-shaped midway during cell division. There is a constricted region on each chromosome. It is called the '**Primary constriction**' or '**Centromere**'. This divides the chromosome into two parts. Each part is called an 'arm'. The centromere has a specific position in each chromosome. Depending upon this, there are four types of chromosomes.

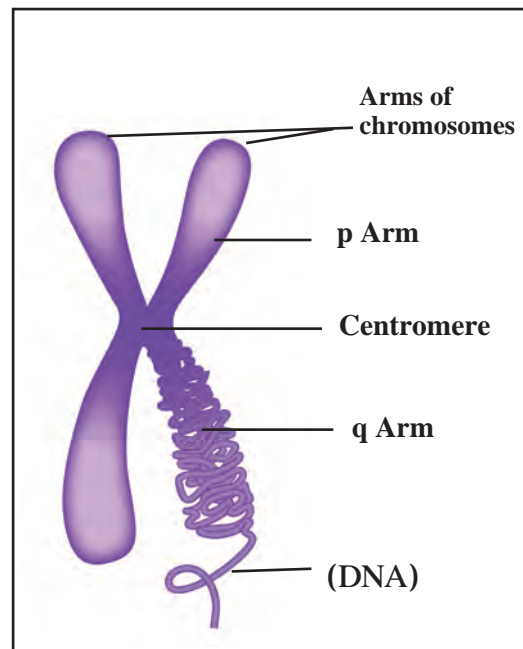

16.2 Organization of chromosome

Types of chromosomes :



Find out

Number of chromosomes in different organisms

Types of chromosomes can be easily identified during cell division.

1. Metacentric : The centromere is exactly at the mid-point in this chromosome, and therefore the chromosome looks like the English letter 'V'. The arms of this chromosome are equal in length.

2. Sub-metacentric : The centromere is somewhere near the mid-point in this chromosome which therefore looks like English letter 'L'. One arm is slightly shorter than the other.

3. Acrocentric : The centromere is near one end of this chromosome which therefore looks like the English letter 'j'. One arm is much smaller than other.

4. Telocentric : The centromere is right at the end of this chromosome making the chromosome look like the English letter 'i'. This chromosome consists of only one arm.

Generally, in somatic cells chromosomes are in pairs. If the pair consists of similar chromosomes by shape and organization, they are called '**homologous chromosomes**' and if they are not similar they are called '**heterologous chromosomes**'. In case of organisms that reproduce sexually one of the chromosomal pairs is different from all than others. Chromosomes of this different pair are called '**sex chromosomes**' or **allosomes** and all other chromosomes are called '**autosomes**'.

Chromosome number of some organisms has been given in the following table -

Sr. No.	Organism	No. of Chromosomes
1	Crab	200
2	Maize	20
3	Frog	26
4	Roundworm	04
5	Potato	48
6	Human	46

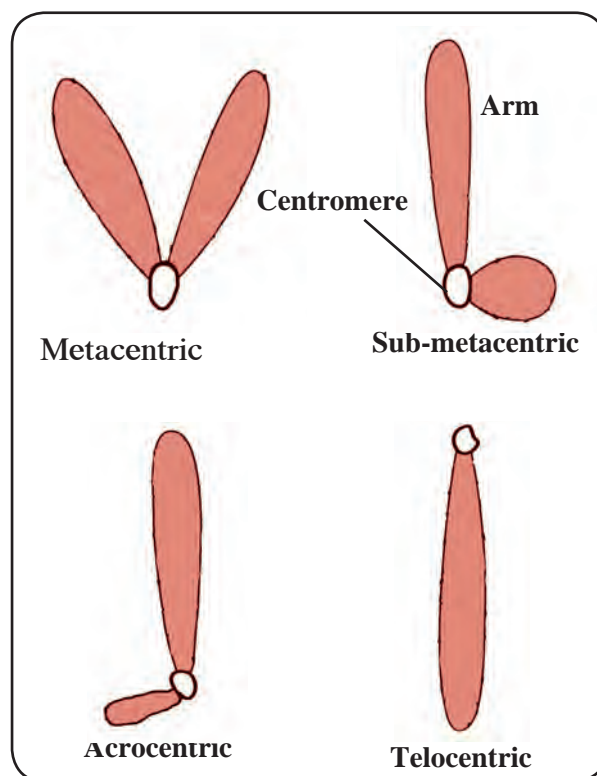

16.3 Types of chromosomes

Deoxyribonucleic acid (DNA)

Chromosomes are mainly made up of DNA. This acid was discovered by the Swiss biochemist, Frederick Miescher in 1869 while studying white blood cells. Initially this acid was reported to be only in the nucleus of cells. Hence, it was named nucleic acid. However, it was later realized that it is present in other parts of the cell too. Molecules of DNA are present in all organisms from viruses and bacteria to human beings. These molecules control the functioning, growth and division (reproduction) of the cell and are therefore called 'Master Molecules'.

The structure of the DNA molecule is the same in all organisms. In 1953, Watson and Crick produced a model of the DNA molecule. As per this model, two parallel threads of nucleotides are coiled around each other. This arrangement is called a 'double helix'. This structure can be compared with a coiled and flexible ladder.

Each strand in the molecule of DNA is made up of many small molecules known as **'nucleotide'**. There are four types of nitrogenous bases adenine, guanine, cytosine and thymine. Adenine and guanine are called as **'purines'** while cytosine and thymine are called **'pyrimidines'**.

In the structure of the nucleotide, a molecule of a nitrogenous base and phosphoric acid are each joined to a molecule of sugar.

As there are four types of nitrogenous bases, nucleotides also are of four types.

Nucleotides are arranged like a chain, in a molecule of DNA. The two threads of the DNA molecule are comparable to the two rails of a ladder and each rail is made up of alternately joined molecules of sugar and phosphoric acid. Each rung of the ladder is a pair of nitrogenous bases joined by hydrogen bonds. Adenine always pairs with thymine and cytosine always pairs with guanine.

Gene

Each chromosome is made up of a single DNA molecule. Segments of the DNA molecule are called genes. Due to variety in the sequence of nucleotides, different kinds of genes are formed. These genes are arranged in a line. Genes control the structure and function of the cells and of the body. Also, they transmit the hereditary characteristics from parents to offspring. Hence, they are said to be the functional units of heredity. That is why, many similarities are seen between parents and their offspring. Information about protein synthesis is stored in the genes.

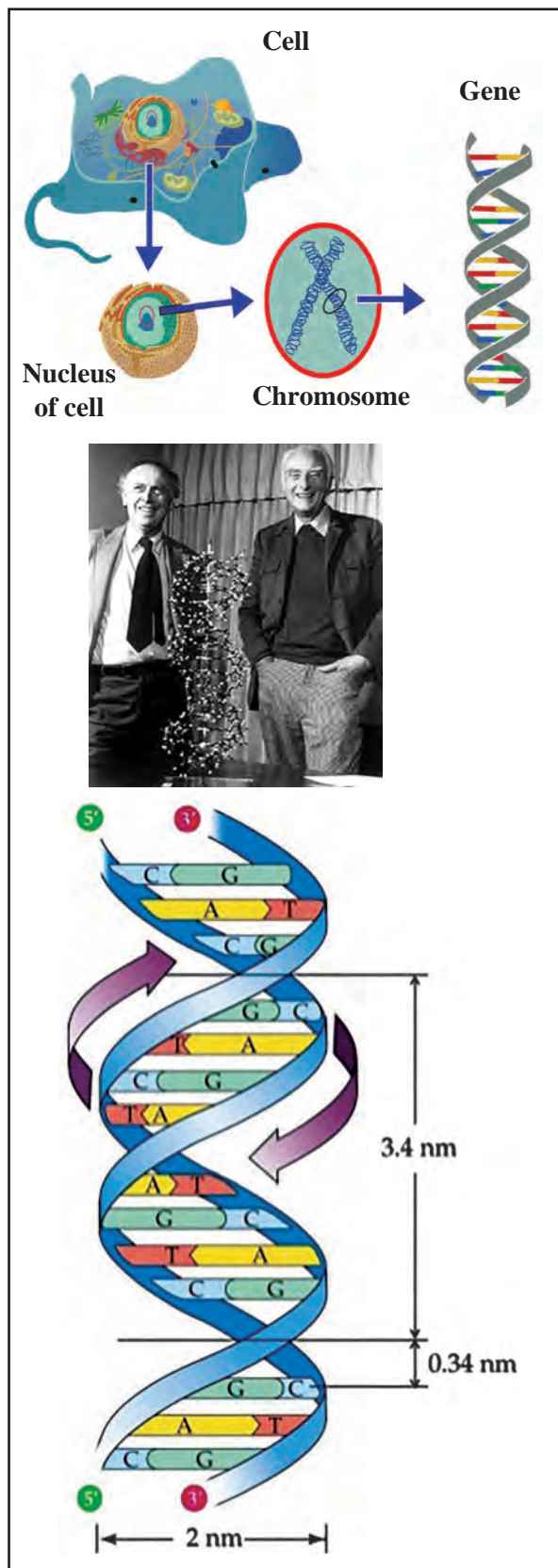

16.4 DNA (Watson and Crick's Model)

DNA fingerprinting : The sequence of the genes in the DNA of a person i.e. the genome of the person is identified. It is useful to identify the lineage and to identify criminals because it is unique to every person.

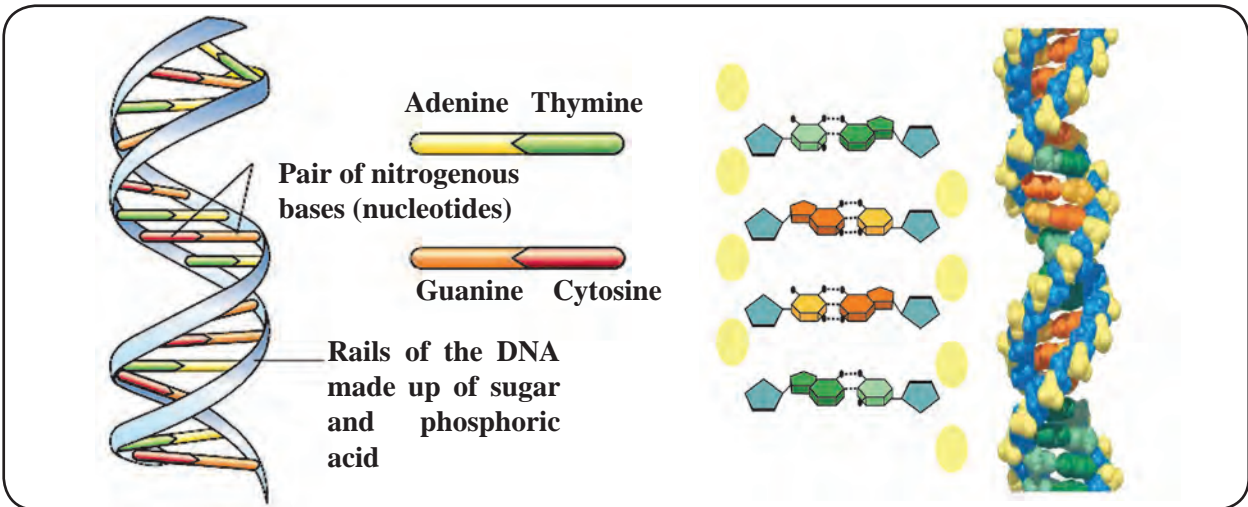

16.5 Structure of DNA

Seeds of technology :

In 1990, the ‘**Human Genome Project**’ was together undertaken by all the geneticists of the world. In June 2000, scientists of this project and Celera Genomics Corporation (a private industry in USA) collectively announced the discovery of the complete DNA sequence of the human genome. Depending upon the findings of this project, scientists confirmed that the number of genes in the human genome is about 20,000 to 30,000. Later, scientists discovered the genomic sequence of many microorganisms. Due to research in genomics, disease causing genes can be identified. If disease causing genes are identified, genetic diseases can be diagnosed and properly treated.

Website : www.genome.gov

Ribonucleic acid (RNA) :

RNA is the second important nucleic acid of the cell. This nucleic acid is made up of ribose sugar, phosphate molecules and four types of nitrogenous bases adenine, guanine, cytosine and uracil. The nucleotide i.e. smallest unit of the chain of the RNA molecule is formed by combination of a ribose sugar, phosphate molecule and one of the nitrogenous bases. Large numbers of nucleotides are bonded together to form the macromolecule of RNA. According to function, there are three **types of RNA**.

1. Ribosomal RNA (rRNA) : The molecule of RNA which is a component of the ribosome organelle is called a ribosomal RNA. Ribosomes perform the function of protein synthesis.

2. Messenger RNA (mRNA) : The RNA molecule that carries the information of protein synthesis from genes i.e. DNA chain in the cell nucleus to ribosomes in the cytoplasm which produce the proteins, is called messenger RNA.



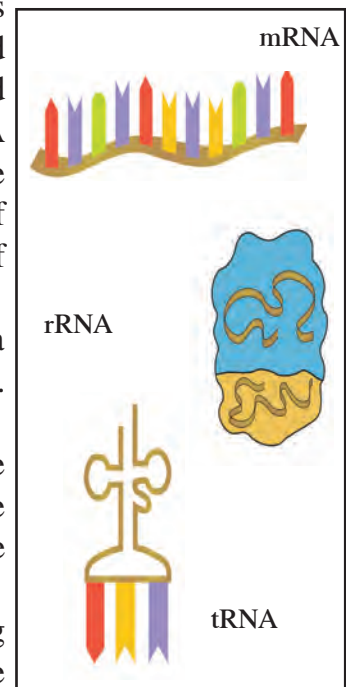











3. Transfer RNA (tRNA) : The RNA molecule which, according to the message of the mRNA carries the amino acid up to the ribosomes is called transfer RNA.



16.6 Types of RNA

Mendel's principles of heredity

Genetic material is transferred in equal quantity from parents to progeny. Principles of heredity are based upon this fact. If both the parents make equal contribution to inheritance of characteristics, which characteristics will appear in the progeny? Mendel carried out research in this direction and put forth the principles of heredity responsible for such inheritance. The experiments performed by Mendel, almost a century ago are quite astonishing. All of Mendel's experiments were based upon the visible characteristics of the pea plant (*Pisum sativum*). These characteristics are as follows -

	Dominant	Recessive
Shape of the seed	 Round (R)	 Wrinkled (r)
Colour of seed	 Yellow (Y)	 Green (y)
Colour of flower	 Purple (C)	 White (c)
Shape of pod	 Inflated (I)	 Constricted (i)
Colour of pod	 Green (G)	 Yellow (g)
Position of flower	 Axillary (A)	 Terminal (a)
Height of plant	 Tall (T)	 Dwarf (t)

16.7 Seven mutually contrasting visible characteristics

An introduction to scientists



Gregor Johann Mendel

(Birth: 20th July 1822, Death: 6th Jan 1884)

Gregor Johann Mendel was an Austrian scientist. He studied the inheritance of some characteristics of the pea plant. He showed that inheritance of these characteristics follows certain principles. Later, these principles become popular by his name. Mendel's work was recognized only in the 20th century. After a reconfirmation of these principles, the same principles now form the basis of modern genetics.



Do you know?

Some dominant and recessive characteristics of human beings

Dominant	Recessive
Rolling tongue	Non-rolling tongue
Presence of hair on arms	Absence of hairs on arms
Black and curly hair	Brown and straight hair
Free earlobe	Attached earlobe

We shall study the following crosses to clearly understand the conclusions of Mendel's experiments.

Monohybrid cross

In this experiment, Mendel brought about the cross between two pea plants with only one pair of contrasting characters. This type of cross is called a monohybrid cross.

So as to study the monohybrid ratio, let us consider the characteristic 'plant height' with a pair of contrasting characteristics tall plant and dwarf plant.

Parental generation (P₁) :

Tall pea plants and dwarf pea plant were used in this cross. Hence, this is parent generation (P₁). Mendel referred to the tall and dwarf plants as dominant and recessive respectively. The tall plant was referred to as dominant because all the plants in the next generation were tall. The dwarf plant was referred to as recessive because this characteristic did not appear in next generation at all. This experiment has been presented by the 'Punnet Square' method as shown below.

Mendel's experiment of the Monohybrid Cross

Parental Generation (P₁)

Phenotype: Tall Dwarf

Genotype: T T t t

Gametes: T t

First Filial Generation (F₁)

Tt

Phenotype: Tall

Parental Generation (P₂) Selfing in F₁

Phenotype: Tall Tall

Genotype: Tt Tt

Gametes: T and t T and t

First Filial Generation (F₂)

		Male gamete	
		T	t
Female gamete	T	TT (Tall)	Tt (Tall)
	t	Tt (Tall)	tt (Dwarf)

Depending upon these observations, Mendel proposed that the factors responsible for inheritance of characteristics are present in pairs. Today, we refer to these factors as genes. Dominant genes are denoted by capital letters whereas recessive genes are denoted by small letters. As genes are present in pairs, tall plants are denoted by TT and dwarf plants are denoted by tt. During gametogenesis, these genes separate from each other. Due to this, two types of gametes one containing factor T and other containing factor t are formed.

First filial generation (F_1) :

In this experiment, Mendel observed that all plants of first filial generation (F_1) were tall. But, he realised that tall plants of F_1 generation were different from the tall plants of P_1 generation because parents of F_1 tall plants are tall as well as dwarf plants. Depending upon observations of F_1 generation, Mendel concluded that factors of tall plants are dominant over the factors of dwarf plants. Though all the plants in F_1 generation were tall, they contained the factor responsible for dwarfness. i.e. though the phenotype of F_1 plants is tall, their genotype is mixed. Phenotype means external appearance or visible characteristics of organisms, for example, tallness or dwarfness of plants whereas genotype means the pairs of genes (factors) responsible for the visible characteristics. Genotype of P_1 tall plants is TT and produces only one type of gametes (T). Genotype of F_1 tall plants is Tt and it produces two types of gametes, T and t. Thus, based on this, we can say that in case of tall plants of F_1 and P_1 generations, though they show similar phenotype, their genotypes are different. Mendel further continued this experiment and brought about self-fertilization in F_1 plants from which a second filial (F_2) generation was produced.

Second filial generation (F_2):

In the second filial generation (F_2), both i.e. tall and dwarf types of plants appeared. According to the data collected by Mendel, out of 929 pea plants, 705 were tall and 224 were short. Thus, the phenotypic ratio of these plants is 3(tall):1(dwarf) and genotypic ratio is 1(TT):2(Tt):1(tt). Thus, it can be inferred that in the F_2 generation, phenotypically there are two types of plants whereas genotypically there are three types. These types are shown in the following table.

F_2 Pure dominant (TT) - tall plants	Homozygous
F_2 Pure recessive (tt) - dwarf plants	Homozygous
F_2 Hybrid plants (Tt) -tall plants	Heterozygous

Mendel's experiment on dihybrid cross:

In the dihybrid cross, two pairs of contrasting characteristics are under consideration. Mendel performed more experiments on hybridization in which he considered more than one pair of contrasting characteristics. He brought about a cross between a pea plant producing rounded and yellow coloured seeds and a pea plant with wrinkled and green coloured seeds. In this cross, two pairs of contrasting characteristics were considered colour of seeds and shape of seeds. Hence, it is called a dihybrid cross.

Parental generation (P_1) :

Mendel selected the pea plants producing rounded yellow seeds and wrinkled green seeds as parent plants, as shown in the chart -

Mendel's experiment of dihybrid cross

Parental Generation (P_1)

Phenotype: Rounded-yellow seeds Wrinkled-green seeds

Genotype: RRYY rryy

Gametes RY ry

First Filial
Generation (F_1)

RrYy

Phenotype: (Rounded-yellow seeds)

Parental Generation (P_2) Selfing in F_1

Phenotype: Rounded-yellow seeds Rounded-yellow seeds

Genotype: RrYy RrYy

Gametes RY, Ry, rY, ry RY, Ry, rY, ry

Second Filial
Generation (F_2)

Male gamete \ Female gamete	RY	Ry	rY	ry
RY	RRYY	RRYy	RrYY	RrYy
Ry	RRYy	RRyy	RrYy	Rryy
rY	RrYY	RrYy	rrYY	rrYy
ry	RrYy	Rryy	rrYy	rryy

During gamete formation in P_1 generation, the pair of gametes separate independently i.e. in RRYY plants, only RY type gametes are formed and not RR and YY. Similarly, in rryy plants, only ry gametes are formed. Thus we can say that each pair of genes is represented in the gamete by only one gene from that pair.



Use your brain power !

Phenotypic ratio:

1. Round-Yellow:
2. Wrinkled-Yellow:
3. Round-Green:
4. Wrinkled-Green:

Genotypic ratio :

Genotypic ratio :

RRYY -
RRYy -
RRyy -
RrYY -
RrYy -
Rryy -
rrYY -
rrYy -
rryy -

Ratio

= : : : : : : :

1. Show the monohybrid cross between (RR) and (rr) and write the phenotypic and genotypic ratio of F_2 generation.
2. Why did the characteristic of the Rounded-Yellow seeds alone appear in the F_1 generation but not the characteristic of the wrinkled-green seeds?

Based on the conclusions from the monohybrid cross, Mendel expected that in the F_2 generation of dihybrid cross, plants would produce rounded-yellow seeds. He was proved right. Though the genotype of these plants was $RrYy$, their phenotype was like the parents producing rounded-yellow seeds, because yellow colour is dominant over green and round shape is dominant over wrinkled. Due to the combination of two different characteristics in the F_1 generation of the dihybrid cross, these plants are called dihybrid plants.

Plants of the F_1 generation of dihybrid cross produce four types of gametes RY , Ry , rY , ry . Of these gametes, RY and ry are similar to those of the P_1 generation.

F_2 generation is formed through the selfing of F_1 plants. The pattern of inheritance of characteristics from F_1 to F_2 is shown in brief in the table given on page 187 and an activity about its presentation in the form of a ratio has been given in a box, beside it. The 16 different possible combinations through the union of 4 types of male gametes and 4 types of female gametes are shown in a chess-board like table (Punnet Square / Checker board) on page 187. Male gametes are shown at the top of table and female gametes are shown in left column. Observations based on a study of the F_2 generation will be according to the table on page 187.

Genetic disorders

Diseases or disorders occurring due to abnormalities in chromosomes and mutations in genes are called genetic disorders. Chromosomal abnormalities include either increase or decrease in numbers and deletion or translocation of any part of the chromosome. Examples are physical disorders like cleft lip, albinism and physiological disorders like sickle cell anaemia, haemophilia, etc.

Human beings have 46 chromosomes in the form of 23 pairs. There is great variation in the size and shape of these chromosomal pairs. These pairs have been numbered. Out of 23 pairs, 22 pairs are autosomes and one pair is of sex chromosomes (allosomes). Chromosomes in women are represented as $44+XX$ and in men as $44+XY$.

Mendel has shown in his experiments that there exist two type of genes, dominant and recessive.

If we take into account the number of chromosomes in human cells, their sex-related types, the types of genes on the chromosomes - dominant and recessive - we can see where genetic disorders originate and how they are inherited.

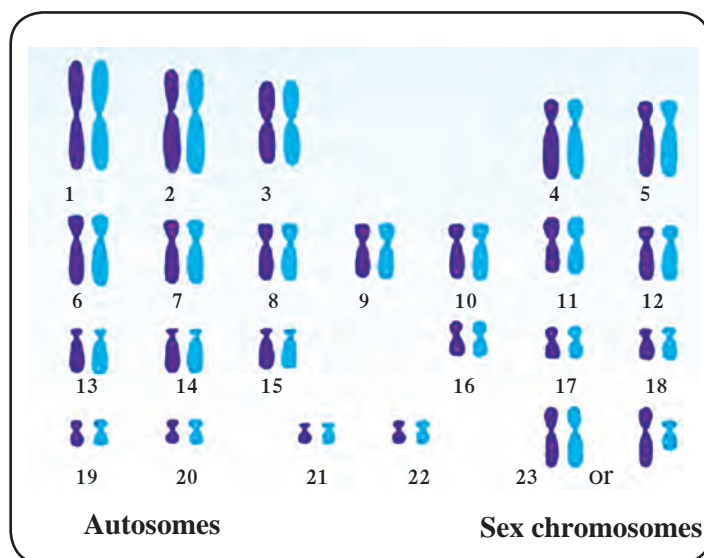

16.8 Human karyotype (Chromosome chart)

A. Disorders due to chromosomal abnormalities:

Following are the disorders that occur due to numerical changes in chromosomes. Offspring are not sterile if there is change in the number of autosomes is less. Instead, if there is an increase in number of any autosomal pair, physical or mental abnormalities arise and the lifespan is shortened with a shortened life span. Following are some disorders.

1. Down syndrome (46+1, Trisomy of 21st Chromosome) :

Down syndrome is a disorder arising due to chromosomal abnormality. This is the first discovered and described chromosomal disorder in human beings. This disorder is characterised by the presence of 47 chromosomes. It is described as trisomy of the 21st chromosome. Infants with this disorder have one extra chromosome with the 21st pair in every cell of their body. Therefore they have 47 chromosomes instead of 46. Children suffering from Down's syndrome are usually mentally retarded and have a short lifespan. Mental retardation is the most prominent characteristic. Other symptoms include short height, short wide neck, flat nose, short fingers, scanty hair, single horizontal crease on palm, and a life expectancy of about 16–20 years.



16.9 Child with Down syndrome

2. Turner syndrome (Monosomy of X chromosome) :

As with autosomes, abnormalities in sex chromosomes also cause some disorders. Turner syndrome (or 44+X) arises due to either inheritance of only one X chromosome from parents or due to inactivation of the gender-related part of X-chromosomes. Instead of the normal 44+XX condition, women suffering from Turner syndrome show a 44+X condition. Such women are sterile i.e. unable to have children due to improper growth of the reproductive organs.



16.10 Hand of a child with Turner syndrome

3. 3. Klinefelter syndrome (44+XXY) :

This disorder arises in men due to abnormalities in sex chromosomes. In this disorder, men have one extra X chromosome; hence their chromosomal condition becomes 44+XXY. Such men are sexually sterile because their reproductive organs are not well developed.

National Health Mission

Under the National Health Mission, the National Rural Health Mission has been started since April 2005 and the National Urban Health Mission since 2013.

The main objectives of this mission are strengthening of the rural and urban health facilities, controlling various diseases and illnesses, increasing public awareness about health, and offering financial assistance to patients through various schemes.

B. Diseases occurring due to mutation in single gene (monogenic disorders) :

Disorders or diseases occurring due to mutation in any single gene into a defective one are called monogenic disorders. Approximately 4000 different disorders of this type are now known. Due to abnormal genes, their products are either produced in insufficient quantity or not at all. It causes abnormal metabolism that may lead to death at a tender age. Examples of such disorders are Hutchinson's disease, Tay-Sachs disease, galactosaemia, phenylketonuria, sickle cell anaemia, cystic fibrosis, albinism, haemophilia, night blindness, etc.

1. Albinism :

This is a genetic disorder. Our eyes, skin and hair have colour due to the brown pigment, melanin. In this disease, the body cannot produce melanin. The skin becomes pale, hairs are white and eyes are usually pink due to absence of melanin pigment in the retina and sclera.

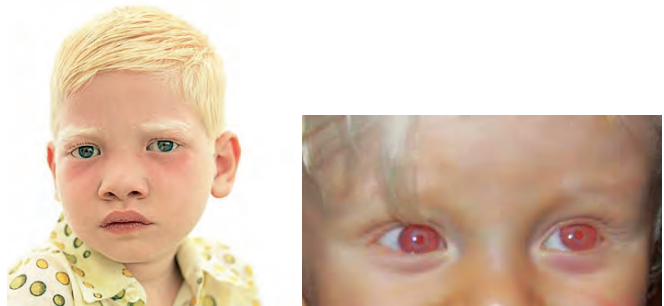

16.11 Hair and eyes of child with albinism

2. Sickle-cell anaemia :

Even minor changes in molecular structure of proteins and DNA may lead to diseases or disorders. Normal haemoglobin has glutamic acid as the 6th amino acid in its molecular structure. However, if it is replaced by valine, the shape/structure of the haemoglobin molecule changes. Due to this, the erythrocytes or red blood corpuscles (RBC), which are normally biconcave become sickle-shaped. This condition is called 'sickle-cell anaemia'. The oxygen carrying capacity of haemoglobin in such individuals is very low.

In this condition, clumping and thereby destruction of erythrocytes occurs most often. As a result blood vessels are obstructed and the circulatory system, brain, lungs, kidneys, etc. are damaged. Sickle-cell anaemia is a hereditary disease. It occurs due to changes in genes during conception. If the father and mother are both affected by sickle-cell anaemia or if they are carriers of this disorder, their offspring are likely to suffer from this disease. Hence, marriages between the persons who are carriers of or suffering from sickle-cell anaemia should be avoided.

There are two types of persons affected by sickle-cell anaemia :

1. Sickle-cell anaemia carrier (AS)
2. Sufferer from sickle-cell anaemia (SS)

Symptoms of sickle-cell anaemia :

Swelling of hands and legs, pain in joints, severe general body aches, frequent colds and cough, constant low grade fever, exhaustion, pale face, low haemoglobin content.



Do you know?

In Maharashtra, there are more than 2.5 lakh people suffering from sickle-cell anaemia and about 21 districts including 11 districts from Vidarbha are affected by this disorder.

Let's get our blood tested !
Let's overcome sickle cell anaemia !

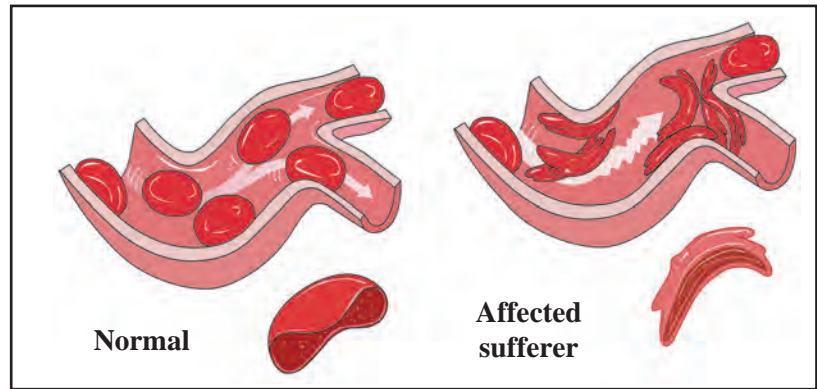

16.12 Sickle cells

Sickle cell anaemia occurs as follows :

Symbols: AA = Normal, AS = Carrier, SS = Sufferer

Sr. No.	Man	Woman	Progeny
1	AA	AA	Normal progeny if both parents are normal.
2	AA or AS	AS or AA	50% progeny normal and 50% carrier, if one parent is normal and one is a carrier.
3	AA or SS	SS or AA	All progeny will be carrier, if one parent is normal and one is a sufferer.
4	AS	AS	25% progeny normal, 25% sufferer and 50% carrier if both parents are carriers.
5	AS or SS	SS or AS	50% progeny carrier and 50% sufferer if one parent is carrier and one is a sufferer.
6	SS	SS	All progeny will be sufferers if both parents are sufferers.

Diagnosis of sickle-cell anaemia : Under the National Health Mission scheme, the 'Solubility Test' for diagnosis of sickle-cell anaemia is available at all district hospitals. Similarly, the confirmatory diagnostic test- 'Electrophoresis' is performed at rural and sub-district hospitals.

Remedies :

This disease is spread in only one way i.e. reproduction. Hence, husband and wife should get their blood examined either before marriage or after it.

1. A carrier or sufferer should avoid marriage with another carrier or sufferer.
2. A person suffering from sickle cell anaemia should take a tablet of folic acid daily.



16.13 Hand of a child with sickle-cell anaemia

C. Mitochondrial disorder :

Mitochondrial DNA may also become defective due to mutation. During fertilization, mitochondria are contributed by the egg cell (ovum) alone. Hence, mitochondrial disorders are inherited from the mother only. Leber hereditary optic neuropathy is an example of a mitochondrial disorder.

D] Disorders due to mutations in multiple genes : (Polygenic disorders)

Sometimes, disorders arise due to mutations in more than one gene. In most such disorders, their severity increases due to effects of environmental factors on the foetus. Common examples of such disorders are cleft lip, cleft palate, constricted stomach, spina bifida (a defect of the spinal cord), etc. Besides, diabetes, blood pressure, heart disorders, asthma, obesity are also polygenic disorders. Polygenic disorders do not strictly follow Mendel's principles of heredity. These disorders arise from a complex interaction between environment, life style and defects in several genes.



Always remember

Inter-relationship between tobacco addiction and cancer (Uncontrolled growth of cells)

Many people consume tobacco, either by smoking or by chewing. Consumption of tobacco in any form can cause cancer. Smoking of cigarettes and *bidi* adversely affects the process of digestion. It causes a burning sensation in the throat and a cough. Excessive smoking causes instability and trembling of fingers. A dry cough causes sleeplessness. Tobacco consumption can also lead to shortening of life span, chronic bronchitis, pericarditis, cancer of the lungs, mouth, larynx (voice box), pharynx, pancreas, urinary bladder, etc.

Harmful effects of smoking are due to the nicotine present in tobacco. It affects the central and peripheral nervous system. Arteries become hard i.e. it causes arteriosclerosis and hypertension.

Tobacco smoke contains harmful chemicals like pyridine, ammonia, aldehyde furfural, carbon monoxide, nicotine, sulphur dioxide, etc. They cause uncontrolled cell division. Tobacco smoke is full of minute carbon particles which causes normal tissue of the lung to transform into thickened black tissue. This causes cancer. While chewing tobacco or tobacco products much of the extract is absorbed into the body. Excessive tobacco consumption may cause cancer of lips or tongue, visual disorders or tremors.

To protect one's body from cancer one must avoid smoking and consumption of tobacco and tobacco products in any form.



Compose and present a street play against tobacco consumption and participate in a drive against tobacco.

Exercises



1. Complete the following sentences by choosing the appropriate words from the brackets.

(Inheritance, sexual reproduction, asexual reproduction, chromosomes, DNA, RNA, gene)

- Hereditary characters are transferred from parents to offsprings by, hence they are said to be structural and functional units of heredity.
- Organisms produced by show minor variations.
- The component which is in the nuclei of cells and carries the hereditary characteristics is called
- Chromosomes are mainly made up of
- Organisms produced through show major variations.

2. Explain following.

- Explain Mendel's monohybrid progeny with the help of any one cross.
- Explain Mendel's dihybrid ratio with the help of any one cross.
- Distinguish between monohybrid and dihybrid cross.
- Is it right to avoid living with a person suffering from a genetic disorder?

3. Answers the following questions in your own words.

- What is meant by 'chromosome'. Explain its types.
- Describe the structure of the DNA molecule.
- Express your opinion about the use of DNA fingerprinting.
- Explain the structure, function and types of RNA.
- Why is it necessary for people to have their blood examined before marriage?

4. Write a brief note on each.

- Down syndrome
- Monogenic disorders
- Sickle cell anaemia: symptoms and treatment.

5. How are the items in groups A, B and C inter-related?

A	B	C
Leber hereditary optic neuropathy	44+XXY	Pale skin, white hairs
Diabetes	45+X	Men are sterile
Albinism	Mito-chondrial disorder	Women are sterile
Turner syndrome	Polygenic disorder	This disorder arises during development of zygote.
Klinefelter syndrome	Mono-genic disorder	Effect on blood-glucose level.

6. Filling the blanks based on the given relationship.

- 44+X:Turner syndrome: :44+XXY:-
.....
- 3:1 Monohybrid: : 9:3:3:1 :
- Women : Turner syndrome : : Men :

7. Complete the tree diagram below based on types of hereditary disorders.

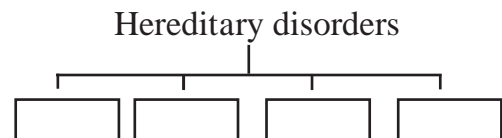

Activity

- Prepare a model of the DNA and give a presentation based on it.
- Prepare a power point presentation on awareness about tobacco consumption and cancer and present it in the class.



17. Introduction to Biotechnology



- Tissues: animal tissues and plant tissues
- Tissue culture
- Agritourism
- Agri-business



Can you recall?

1. Which components bring about important processes in the living organisms?
2. Which is the smallest structural and functional unit of the body of living organisms?

Tissue

In the case of amoeba-like unicellular organisms, all functions are performed by organelles of that single cell. However, most of the organisms are multicellular. How are the various processes brought in their body? Groups of cells come together, so as to perform the various functions of the body.

Are you familiar with the sequence- letters → words → sentences → lessons → text book?

Similarly, organization of the body of organisms follows a definite hierarchy. You have already studied cells and cell organelles in that hierarchy.

‘A group of cells having the same origin, same structure and same function is called ‘tissue’. Millions of cells are present in the body of multicellular organisms. These cells are divided into different groups and each group performs a definite function. For example, we can perform movements due to contraction-relaxation of muscles. Conducting tissues in plants transport water and food to all its parts. All functions of the body occur with full efficiency due to the specific organization of cells and their division of work.

Types of tissue

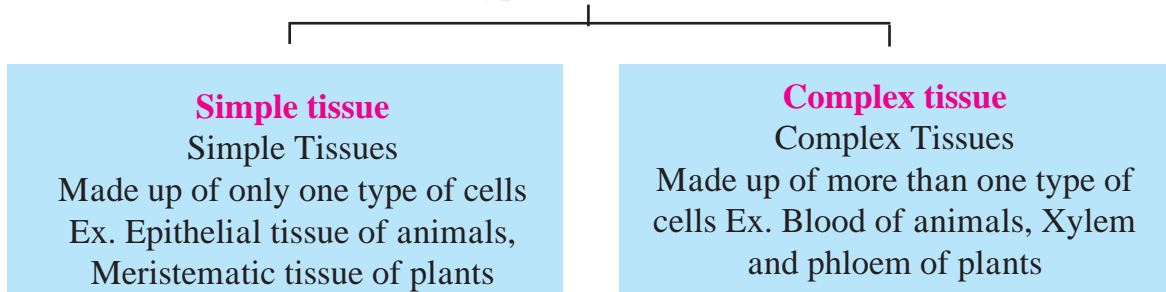

Think about it

Are the structure and functions of the bodies of plants and animals the same?

Plants being sedentary, most of their tissues are of the type that give support. There are dead cells in some tissues and these do not need much attention. Growth of the plants occurs in specific parts of their body where the tissues contain dividing cells. As animals have to move from place to place in search of food, shelter and partners, their energy needs are greater. Most of the tissues of animals are made up of living cells. Uniform growth occurs throughout the body of an animal and they do not have different dividing and non-dividing tissue. This means that plants and animals have different types of tissue to performing the necessary functions.

Animal tissue



Think about it

Why can we not see our organs like the heart, blood vessels and intestines?

In the body of animal different organs come together to perform a specific function. Organs like the lungs and trachea, with the help of the contraction and relaxation of some muscles bring about the function of respiration. Different tissues perform different functions in the organs. Accordingly, tissues are classified into different types.

There are four main types of animal tissues, namely epithelial tissue, connective tissue, muscular tissue and nervous tissue.

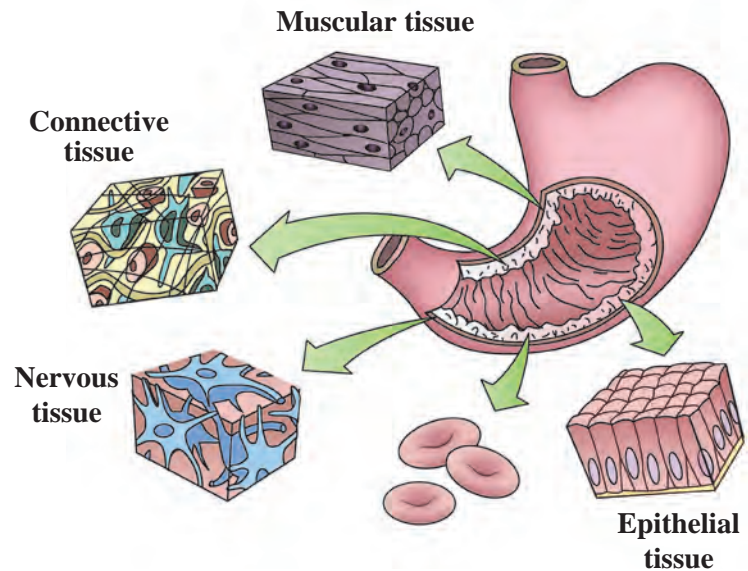

17.1 Types of animal tissues



Do you know?

Blood is also a type of connective tissue. It circulates in our body from one part to another and transports different materials. For example, it transports oxygen and nutrients to all cells in the body. Similarly, it transports waste materials generated all over the body to the kidney for excretion.



Observe

Observe the skin of the back of your hand with the help of a magnifying lens. Do you see the closely attached squarish and pentagonal shapes?

Epithelial tissue



Protective coverings in the animal body are called epithelial tissues. Cells in this tissue are closely packed and form continuous layers. Any material that enters the body first encounters epithelial tissue. Cells of epithelial tissue are separated from the cells of other underlying tissues by a fibrous membrane. The skin, mucous layer of the mouth cavity, inner surface of blood vessels, walls of the alveoli, etc. are made up of epithelial tissues.



Use your brain power !

What keeps the various organs and organ systems separate from each other? How?

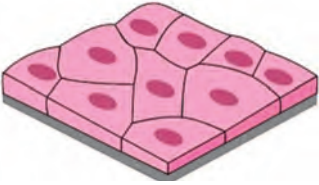
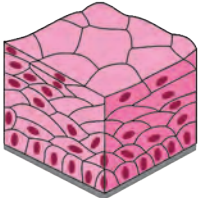
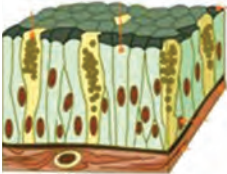
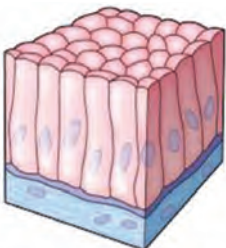
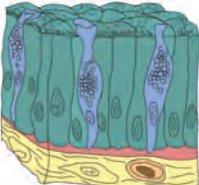
Types of epithelial tissues

Name	Appearance (diagrammatic)	Location	Structure	Function
Squamous epithelium		Inner surface of mouth, oesophagus, blood-vessels, alveoli	Thin, small, flat cells form semipermeable membrane.	Selective transport of substances.
Stratified epithelium		Outer layer of skin	Many layers of cells	Prevention of wearing of organs, protection of organs.
Glandular epithelium		Inner layer of skin, etc.	Cells contain vesicles packed with secretory material	Secretion of sweat, oil (sebum), mucus, etc.
Columnar epithelium		Inner surface (mucosa) of intestine, alimentary canal	Column-like tall cells. Upper free surface bears folds made of these cells at places of absorption	Secretion of digestive juice, absorption of nutrients
Ciliated Epithelium		Inner surface of respiratory tract	Upper free surface of cells bears minute hair-like processes	Push mucus and air forward to keep the air passage free
Cuboidal epithelium		Tubules of kidney (nephron), salivary gland	Cells are cuboidal	Reabsorption of useful materials from urine, secretion of saliva



Use your brain power !

Why are epithelial tissues said to be simple tissues?





Observe

Observe a permanent slide of a blood smear under a compound microscope. What did you see?

Cells of different types, colour and shape are mixed together. Hence, blood is a type of complex tissue.

Connective tissue : Tissues which join different parts of the body are called connective tissues. Cells in this type of tissue are loosely arranged with a ground substance in the free spaces in between. The ground substance may be solid, liquid like water or jelly-like.

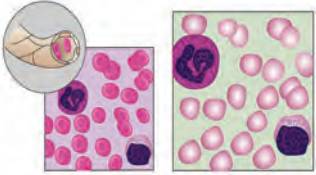
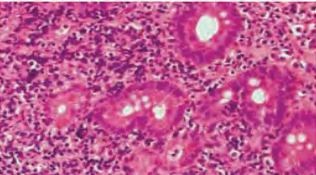
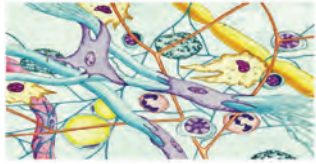
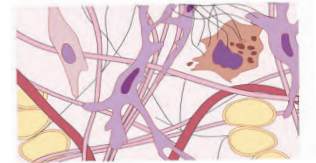
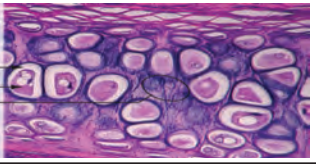
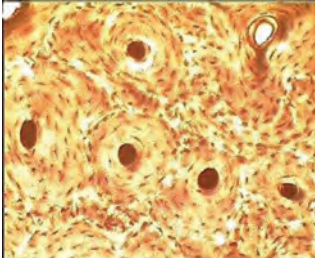
Types of connective tissue

Type	Appearance (diagrammatic)	Location	Structure	Function
Blood		Closed circulatory system	Erythrocytes, leucocytes and platelets in a liquid plasma	Transport of oxygen nutrients, hormones and waste.
Lymph		All around the cells in the body.	Fluid oozed out of blood capillaries, contains leucocytes and liquid ground substance	Protection of body from infections.
Areolar Tissue		Between the skin and muscles, around blood vessels	Different types of cells loosely arranged and supported by a jelly-like ground substance and elastic fibres	Supports internal organs
Adipose Tissue		Below the skin and around internal organs.	Cells filled with fat droplets, jelly-like ground substance	Insulation, supply of energy, storage of fats
Cartilage		Nose, ear, larynx, trachea	Cells supported by fibrous, flexible Jelly-like ground substance	Lubricates the surfaces of bones, gives support and shape to organs
Bones		Skeleton (A specific structure extending throughout the body)	Osteocytes embedded in solid ground substance made up of calcium phosphate	Supports and protects different organs, helps in movement
Tendons and ligaments		At the joints	Tendons: fibrous, strong, less elastic Ligaments: strong and highly flexible	Tendons: join muscles to bones Ligaments: join two bones to each other



Use your brain power !

1. Why do slim persons feel more cold in winter than those who are obese?
2. Why can bones not be folded?

Muscular tissue



Try this

Bend your arm at elbow. Observe the muscles in the front and the back of the arm. Straighten the arm and observe the same muscles again. Do the same with your leg folding it at the knee joint. Did you experience the contraction and relaxation of muscles at every movement?

Muscle fibres and muscular tissues are formed from special type of contractile proteins due to which this contraction and relaxation is possible. Muscular tissues are made up of the long cells of muscle fibres. Muscular movement occurs due to contraction and relaxation of the contractile proteins in these cells.

Types of muscular tissues

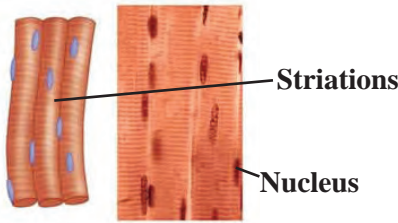
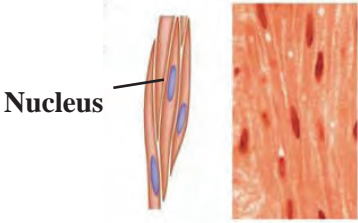
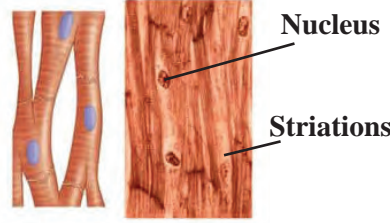
Straited muscles	Non-striated muscles	Cardiac muscles
		
Muscle cells are long, cylindrical, multinucleate and have no branches.	Muscle cells are short, spindle-shaped, uninucleate and have no branches.	Muscle cells are cylindrical, uninucleate and branched.
Structure: There are alternate dark and light bands on these muscles as they are attached to bones, they are also called skeletal muscles. They move as per our will, hence they are called voluntary muscles.	Structure: Dark and light bands are absent. Not attached to bones. Their movements are not under the control of our will, hence they are called involuntary muscles. They are present in the alimentary canal, blood vessels, etc.	Structure: Dark and light bands are present. The heart is made of these muscles. Their movements are not under the control of our will. They contract and relax rhythmically.
Function: These muscles bring about movements of arms and legs, running, speaking, etc.	Function: Movements of eye lids, passage of food through alimentary canal, contraction and relaxation of blood vessels	Function: Contraction and relaxation of the heart.



Can you recall?

Which type of muscle is the diaphragm of the respiratory system?



Try this

Close your eyes and try to identify different objects by feeling them with your hand. Why is it possible for you to identify things like a notebook, text-book, bench, compass-box, etc, only by touching them?

Nervous tissue

Often you must have identified the singer by merely listening to the song or identified what is being cooked in the kitchen by the mere smell! What helps us do this?

Nervous tissue enables us to respond to stimuli like touch, sound, odour, colour, etc.

Cells of the nervous tissue are specially made to become excited and to conduct that excitation from one part of body to other. The cell body which contains the cytoplasm and the nucleus is the main part of each nerve cell. Numerous, small, branched fibres called dendrites arise from the cell body. One of the fibres, however, is extremely long. It is called as the axon. The length of a nerve cell may even be up to one meter. Many nerve cells are bound together with the help of connective tissue to form a nerve. Nervous tissue is present in the brain, spinal cord and the network of nerves spread all through the body. In most animals, action in response to a stimulus occurs due to the integrated functioning of nervous tissue and muscular tissue.

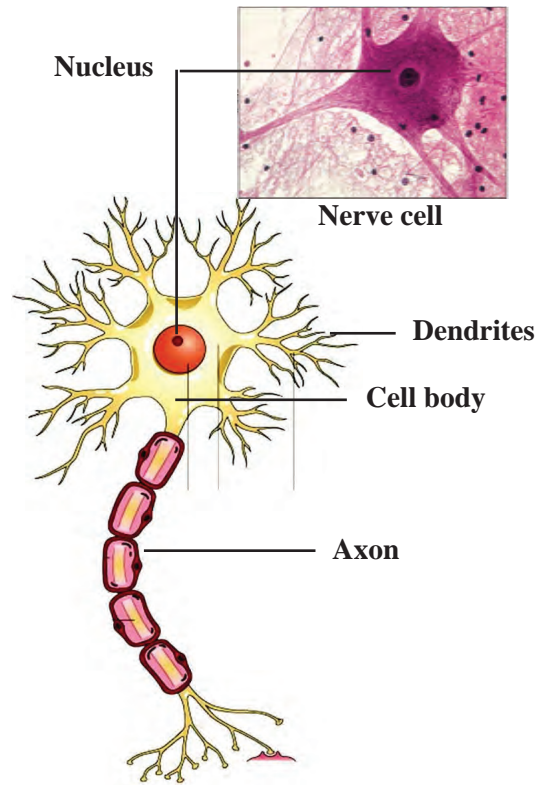

17.2 Nerve cell : A unit of nervous tissue

Plant tissue



Can you recall?

1. What is the main difference between the growth of animals and plants?
2. Why does the growth of a plant occur only at specific parts of the plant body?



Try this

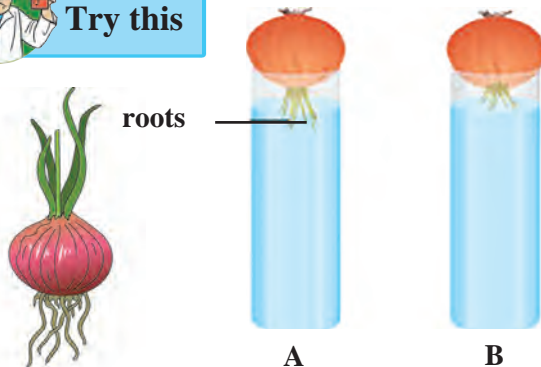

17.3 Changes in roots of onion

As shown in the figure 17.3, place an onion on each gas jar in such a way that its base (roots) will remain dipped in water. Measure and record the length of the roots of both onions on the first, second and third day. On the fourth day, cut off 1 cm of the roots of the onion in flask B.

Measure the length of the roots of both onions for the next five days and record your observations in the following table.

Length (cm)	Day 1	Day 2	Day 3	Day 4	Day 5
Flask A					
Flask B					

1. Which onion has longer roots? Why?
2. Why did the roots of the onion in jar B stop growing?

Meristematic tissue

As meristematic tissue is present in specific parts of a plant, growth occurs in those parts only. Cells of meristematic tissue contain thick cytoplasm, a conspicuous nucleus and a thin cell wall and are compactly packed together. Vacuoles are usually absent in these cells. These cells are highly active. To bring about plant growth is the main function of meristematic tissue. According to the location, meristematic tissue is of three types as given below.

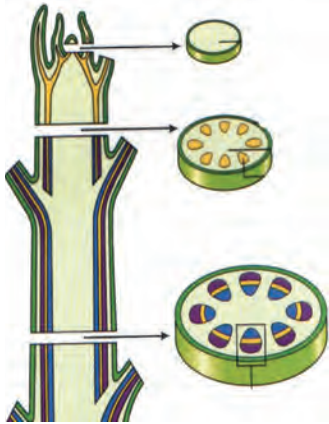
Figure	Location	Function
	Apical meristem : At the tip of the root and stem	Increases the length of the root and stem.
	Intercalary meristem : At the base of the petiole of leaves and of branches.	Growth of branches, formation of leaves and flowers.
	Lateral meristem : Lateral sides of root and stem	Increases girth (diameter) of the root and stem.

17.4 Location of meristematic tissues in plants

Permanent tissue

After their growth is complete, new cells formed by division of meristematic tissue lose their ability to divide and start to perform a specific function at specific place. Thus, they permanently acquire a specific structure, shape and location and perform a specific function. This is called as differentiation and permanent tissues are formed from these differentiated cells. There are two types of permanent tissues-simple permanent and complex permanent tissue.

Simple permanent tissues

These are made up of only one type of cells. According to function, they are of the following different types.

Epidermis



Try this



Take a fresh and fleshy leaf of *Rhoexo*, lily or any other plant. Pull and press it, tearing it obliquely in such a way that its transparent epidermis will be visible at the cut margins. Take the transparent epidermis with the forceps and keep it in dilute safranin solution. for 1 minute. Spread it on a slide, cover with a cover-slip and observe it under a compound microscope.

The entire outer surface of a plant is made up of only one layer of cells. That layer is called 'epidermis'. Cells of the epidermis are flat and as there are no intercellular spaces between them, a single continuous layer is formed. The epidermis of the stem and leaves is covered by a waxy layer of 'cuticle' due to which water in the

17.5 Tissue of *Rhoexo* plant

Types of simple permanent tissues

Name of Tissue	Parenchyma	Collenchyma	Sclerenchyma
Figure	<p>Inter-cellular spaces Vacuole Chloroplasts</p>	<p>Vacuole Cell wall</p>	<p>Simple pit pair Lumen (cavity) Lignified thick cell wall</p>
Structure of Cells	Living cells with thin cell wall and intercellular spaces	Elongated living cells with thickened cell wall at corners due to cellulose and pectin	Dead and fibrous cells with tapering ends, cell wall contains lignin
Location	All parts like roots, stem, leaves, flowers and seeds	At the base of leaf petiole, branches and stem	Stem, veins of leaves, hard coats of seeds, outer covering of coconut
Functions	Support, storage of food and filling vacant spaces	Support and flexibility to various parts	Give strength and rigidity to parts of the plants.
Sub-types	Chlorenchyma: Leaves, performs photosynthesis. Aerenchyma : Helps aquatic plants, leaves and stem to float		

Types of complex permanent tissues

Name of tissue	Xylem	Phloem
Figure	<p>Tracheid Vessel element Xylem Phloem Sieve tube Companion cell</p>	
Characteristics	Consists of thick-walled dead cells	Consists of cytoplasm containing living cells
Types of cells	Tracheids, vessels and xylem fibres-dead cells Xylem parenchyma-living cells	Sieve tubes, companion cells, phloem parenchyma- living cells Phloem fibres- dead cells
Function	Structure like interconnected tubes,conduct water and minerals only in upward direction.	Tubes joined to each other, conduct sugar and amino acids from leaves to various parts in upward and downward direction

Some cells in the body of living organisms are ‘**totipotent**’, that is if provided a proper environment, a new organism can grow from these cells. It was realized that with the help of this property of the cells and their genetically controlled biochemical processes, varieties of high yielding crops and new species of animals and various vaccines could be produced. This led to the rise of a new branch in biology, ‘biotechnology’.

Biotechnology

With the help of this technique it has become possible to produce plants and animals bearing some new characteristics in addition to their natural ones. The techniques of bringing about improvements in living organisms by artificial genetic changes and by hybridization for the welfare of human beings, are together called ‘Biotechnology’. It includes the techniques of genetic engineering and tissue culture. Its uses are in the production of cash crops, improvement in varieties of cash crops, increase in abilities of plants to withstand environmental stresses, vaccine production, early diagnosis of congenital diseases, organ transplant, cancer research, production of artificial skin, cartilage, etc. in laboratories.

Tissue culture



Can you tell?

Suppose you want to grow a garden like the one shown in the picture, around your home or school. What would you do to achieve that? By which methods will you cultivate those seedlings?



You must have seen flowers of same variety but of 2 or 3 different colours borne by same plant. How is this possible?

Let us learn about a modern technique related to farming and gardening.

17.6 Tissue culture: Plantlets of banana and farming with their help

‘*Ex vivo* growth of cells or tissues in an aseptic and nutrient-rich medium’ is called tissue culture. Nowadays, a complete organism can be developed from a single cell or from tissue with help of the tissue culture technique.

A liquid, solid or gel-like medium prepared from agar, which supplies nutrients and energy necessary for tissue culture is used in this technique.

Using ICT

With the help of the following websites, collect information about tissue culture and make a presentation in the class.

www.britannica.com/science/tissue-culture

[www.encyclopedia.com/plants and animals/agriculture and horticulture](http://www.encyclopedia.com/plants%20and%20animals/agriculture%20and%20horticulture)

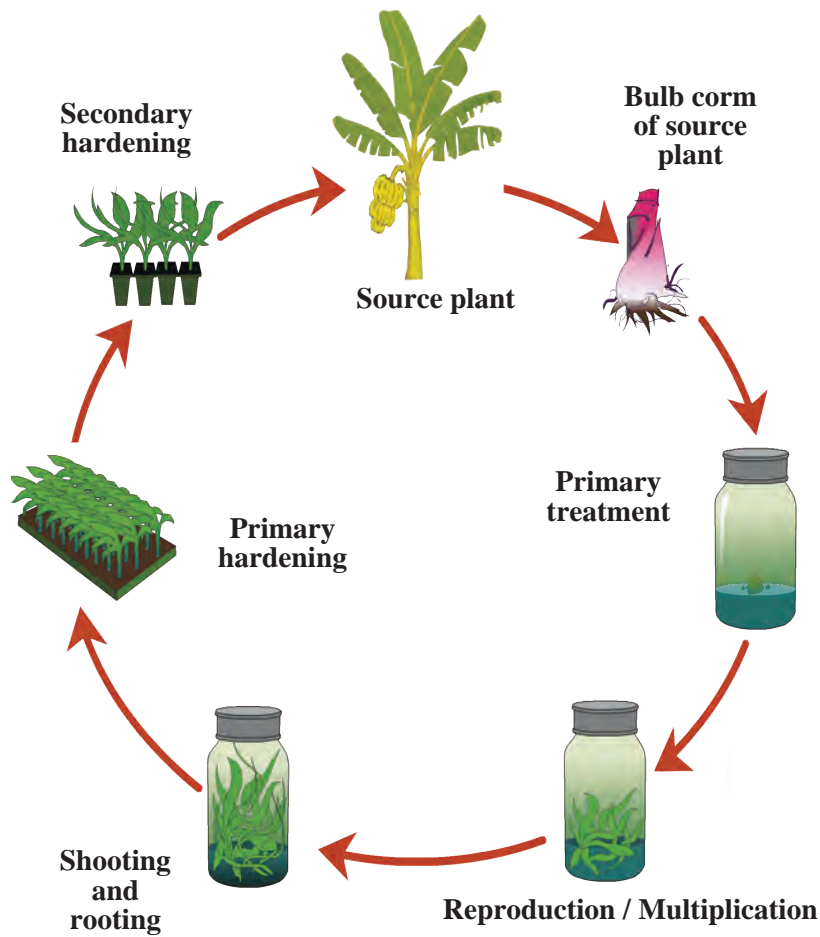

17.7 Various processes in tissue-culture

An introduction to scientists



Frederick Campion Steward (1904–1993) was a British botanist. He had shown that cells and tissues can be grown *ex vivo*. To prove this, he isolated the cells from carrot root and cultured them in a nutrient medium. He also proved that each cell has the ability to produce a new plant.

Changes in agricultural management due to biotechnology

1. Genetically Modified Crops (GM crops) are being produced by introducing changes in DNA of natural crops. Normally, such varieties are not found in nature. Thus, new varieties are produced artificially. Different useful characters are introduced in such varieties.
2. Ability to withstand environmental stress- Some naturally occurring varieties cannot withstand environmental stresses like frequently changing temperature, wet and dry famines, changing climate, etc. However, GM crops can grow in any of such adverse conditions.
3. As GM crops are resistant to insect pests, pathogens, chemical weedicides, etc, the use of harmful chemicals like pesticides can be avoided.
4. Due to use of seeds of GM crops, there is improvement in nutritive value and decrease in loss of crops.



In this way, as seeds of a better quality of crops are being produced, farmers all over the world are cultivating the GM crops on large scale. The area under its cultivation is increasing day by day. High Yielding Varieties of GM crops like banana, maize, rice, potato, soybean, tomato, cotton, apple, brinjal, papaya, beet, rose, tobacco, wheat, etc. are available. Pest-resistant genes have been introduced in some of these GM crops. For example,

Maize : MON 810, MON 863.

Potato : Amflora

Rice : Golden Rice

Soybean : Vistive Gold

Tomato : Vaishali

Cotton : BT cotton

In this way, a 'green evolution' is being achieved through tissue culture and a country like India with a huge population is meeting with success in producing sufficient food-grains for all.

Establish your own plant nursery near your school or home. Prepare the seedlings of flowering plants, fruit plants, and ornamental plants being grown in your area. Can you start a business in the future with the help of this activity? Think it over.



Try this

Application of biotechnology in floriculture, nurseries and forestry

Nurseries are necessary for various purposes like growing gardens on a large scale, afforestation, reforestation, etc. Seedlings have to be supplied in large numbers for all these purposes. It is profitable in such cases to produce plantlets with the help of tissue culture techniques.

1. Tissue culture can be used to grow those plants on a large scale, which bear flowers, fruits of excellent quality.
2. Fully grown plants can be produced in shorter durations.
3. Plants can be grown on a large scale even if means of pollination or germinating seeds are not available. For example, orchids or pitcher plant do not germinate but these plants can easily be produced by means of tissue culture.
4. In a bioreactor, cells can be grown in a more nutritive medium and protected from pathogens. Bioreactors are useful for producing plantlets on a very large scale.



Find out

Collect information about GM varieties of crops in your area and make a note of them. Also find out if there are any adverse effects of GM crops on human beings and the environment.

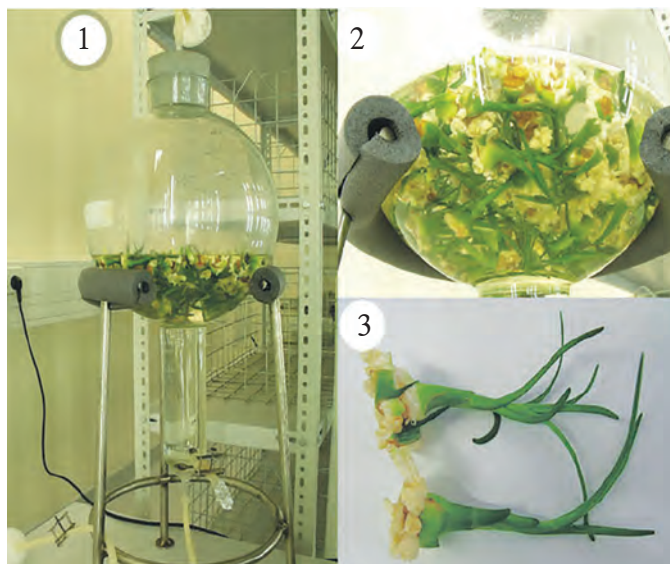

17.8 Bioreactor and production of plantlets

5. Large numbers of seedlings/plantlets can be produced in a short time using minimum resources and materials.
6. Usually, plants produced by tissue culture and genetic modification techniques are disease-free. Plantlets produced by tissue culture of the meristem are virus-free.
7. Embryos formed by conventional hybridization technique between two or more varieties may not grow fully for some reasons. However, embryos produced by tissue culture technique always complete their growth.
8. Rare and endangered plants can be grown by tissue culture technique and can thus be protected from extinction. Similarly, various parts and seeds of such plants can be preserved by tissue culture and those varieties can be protected.

These are the uses of tissue culture and biotechnology in the case of plants. Next year, we will study the use of this technique in the medical field and for conservation of animals.



Use your brain power !

1. Which other industries can be developed as an extension of the of plant nursery business?
2. To which places do people choose to go on vacation in order to relax when they are tired of crowds and a stressful life?

What is inter-relationship between the two questions above?

Agritourism

If sufficient land is available, the emerging field of ‘agri-tourism’ would be a good business. Plantlets of flowering, medicinal, ornamental, vegetable plants and fruit trees can be produced on a large scale by the tissue culture technique. And, by growing some of the plants fully a self-sufficient agritourism centre can be developed.



17.9 Some of the fruit trees in the agritourism centre

- Mango, chikoo (sapota), guava, coconut, custard apple and some other regional fruit trees.
- Shade giving local or exotic attractive plants.
- Ornamental and flowering plants.
- Butterfly garden.
- Medicinal plant garden.
- Organic vegetables and fruits.

People visit places with such attractions in large numbers. Selling plantlets / seedlings, fruits, vegetables at such place can be quite profitable.

Using ICT : www.ecotourdirectory.com/agritourism, www.agritourism.in

Agro-complementary occupations :



Observe and discuss.

A. Animal husbandry

Visit a modern cowshed nearby and record the following points -

The number of cattle, their variety, total milk production, cleanliness in cattle-shed, arrangements for health care of cattle.

In India, animal husbandry is practised for milk production and for using the cattle as help in farming operations. Ex. Cows and buffaloes are raised for milk and bulls and male buffaloes for pulling the heavy loads.

Local Indian varieties of cows like sahiwal, sindhi, gir, lal kandhari, devni, khillari, dangi, etc. and exotic varieties like jersey, brown Swiss, Holstein, etc. are kept for their milk. Proper care of cattle is necessary for a clean and high yield of milk.

1. A balanced diet i.e. which includes all constituents of food should be given to cattle. It must include fibre-rich coarse food, fodder, and sufficient water.
2. The cattle-shed should be clean and dry with proper ventilation and a roof.
3. Cattle should be regularly vaccinated.



Find out

1. What is meant by 'white revolution'? Who was its pioneer? What benefits did it bring?
2. Collect more information about animal husbandry.
3. Find out from the internet the average daily milk yield from local and exotic varieties of cows.







17.10 Animal husbandry

B. Poultry farming

Rearing of egg and meat yielding chickens is called poultry farming.

The objectives behind development of new hybrid varieties from a cross between Indian varieties like Aseel and exotic varieties like Leghorn are as follows : to produce good quality chickens in large numbers, to develop the ability to withstand high temperature, to use by-products of agriculture as poultry feed, etc.

Rhode Island Red, New Hampshire, Plymouth Rock, Black Rock are varieties of chicken reared for eggs as well as meat.

Layers	Broilers
Chickens raised for eggs.	Chickens raised for meat.
Leghorn, Minorca, Ancona, Lehman	Brahma, Long, Cochin, Aseel
 	 

E. Sericulture

Silkworms (moths) are reared for production of silk. *Bombyx mori* is the most commonly used variety for this purpose. The life cycle of the silk moth consists of four stages, namely egg, larva, pupa and adult. Thousands of eggs deposited by female moths are incubated artificially to shorten the incubation period. Larvae hatching out of eggs are released on mulberry plants. Larvae are nourished by feeding on mulberry leaves. After feeding for 3 – 4 days, larvae move to branches of mulberry plant. The silk thread is formed from the secretion of their salivary glands. Larvae spin this thread around themselves to form a cocoon. The cocoon may be spherical in shape.

Ten days before the pupa turns into an adult, all the cocoons are transferred into boiling water. due to the boiling water, the pupa dies in the cocoon and silk fibres become loose. These fibres are unwound, processed and reeled. Various kinds of fabric is woven from silk threads.

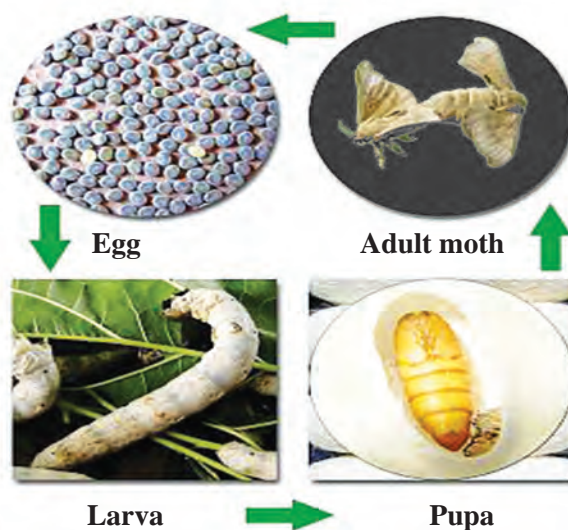

17.10 Life cycle of the silk moth





Use your brain power !

Why are the cocoons transferred to boiling water before the pupa develops into an adult?

Exercises



- Each of the following statements is wrong. Rewrite them correctly by changing either one or two words.**
 - Simple squamous epithelium is present in respiratory tract.
 - Glandular epithelium is present in kidneys.
 - Chlorenchyma helps the plant to float in water.
 - Striated muscles are also called involuntary muscles.
 - Chloroplast is present in permanent tissue.
- Identify the odd word and explain why it is odd.**
 - Xylem, phloem, permanent tissue, meristematic tissue.
 - Epithelium, Muscle fibre, nerve fibre, epidermis.
 - Cartilage, bone, tendon, cardiac muscle.
- Write the names of the following tissues.**
 - Tissue lining inner surface of mouth.
 - Tissue joining muscles and bones.
 - Tissue responsible for increasing height of plants.
 - Tissue responsible for increasing girth of stem.
- Write the differences.**
Simple tissue and complex tissues in plants.
- Write short notes.**
 - Meristematic tissue.
 - Xylem
 - Striated muscles.
 - Agro-complementary business.
 - Genetic engineering
 - Sericulture
- Explain the meaning of biotechnology and its impact on agricultural management with suitable examples.**
- Which two main techniques are used in biotechnology? Why?**
- Discuss 'Agritourism' in the class and write a project on an agro-tourism centre nearby. Present it in the class in groups.**
- Define the term tissue and explain the concept of tissue culture.**
- 'Rearing of sheep is a livestock'. Justify this statement.**

Activity :

- Obtain information about the diversity of butterflies. Collect detailed information about what would have to be done to establish a butterfly garden in your school.
- Visit an apiculture centre and gather information about it.



18. Observing Space : Telescopes



- Forms of light
- Telescopes and types of telescopes
- Telescopes in space
- Indian Space Research Organisation (ISRO)



Can you recall?

1. What is the difference between the sky and space?
2. What is meant by space observation? Why is it important?

From early days, man has been curious about the sun as well as the moon and stars seen in the night sky. Using his boundless imagination, he tried to understand the sky as observed by the naked eyes. He noticed that the position of the stars changed with time and had something to do with the occurrence of seasons. As the knowledge of the cycle of seasons was necessary for agriculture, sky watching began to prove useful to him. The position of the constellations was also useful to sea goers for navigation. Man began to make determined efforts to find answers to questions which arose out of his sky watching. But he did not have any equipment to get a closer view of the stars and planets in the sky.

Today, 400 years after Galileo's use of the telescope, tremendous progress has been made in telescope technology and in space science and technology on the whole. This great leap in technology has helped to construct for us an astounding picture of our universe. Space science and technology are not only important for research purposes, but also to help provide us with many of the comforts and facilities we enjoy in our everyday life. A telescope is used to observe space, but will one telescope be sufficient for us to observe space completely? Why do we need different telescopes for the purpose? Are telescopes installed even in space? In this chapter, we are going to study the science behind many such questions.

An introduction to scientists

In 1608, spectacle maker and researcher, Hans Lippershey discovered that seeing through two lenses kept one behind the other, seems to bring objects closer to us. He thus made the first telescope. Galileo made a telescope in 1609 and used it for space observations. He realized that there are many more stars than what could be seen with naked eyes. Using his telescope, he also discovered the moons of Jupiter, the black spots on the sun, etc.



Galileo Galilei



Different forms of light

Light is an electromagnetic wave. Every wave has a characteristic wavelength. Our eyes can see only that light which has wavelengths between 400 nm to 800 nm. Such light is called visible radiation. However, there are electromagnetic waves of wavelengths other than the visible ones most of which we cannot 'see' as our eyes are not sensitive to them.

Study the following table.

1 nm (nanometer) = 10^{-9} m and 1 pm (picometer) = 10^{-12} m

Type of radiation	Wavelength
Radio waves	Longer than about 20 cm
Micro waves	0.3 mm – 20 cm
Infrared waves	800 nm – 0.3 mm
Visible light rays	400 nm – 800 nm
Ultraviolet rays	300 pm – 400 nm
X-rays	3 pm – 300 pm
Gamma rays	Shorter than 3pm

Of all the above types, our eyes are only capable of seeing the visible radiation. Thus, we use the visible radiation telescopes i.e. optical telescopes, made from regular lenses or mirrors to see the visible radiation coming from the space. However many heavenly bodies emit radiations other than the visible light. Thus we need different types of telescopes like the X-ray, gamma-ray and radio telescopes to receive such radiation and to study their sources.

Telescopes

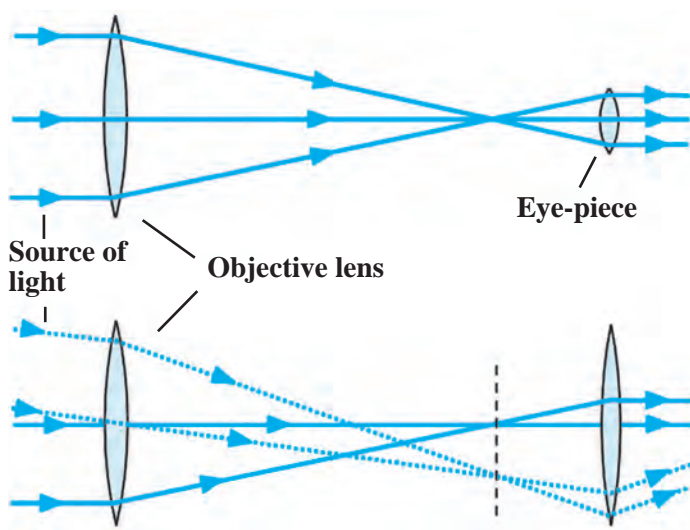

18.1 A refracting telescope

Optical telescopes

Most optical telescopes are made with two or more lenses as shown in figure 18.1. To collect the maximum amount of light coming from a heavenly object, the objective lens should be made as large as possible. Using the light collected by the objective a smaller lens, called the eyepiece, produces a large image of the source. Light rays change their direction as they enter a lens from the atmosphere and again when they enter the atmosphere after passing through the lens. This is called refraction. Hence such telescopes are called **refracting telescopes**. We shall study image formation by lenses in the next standard.

Even though such a telescope is useful for space observations, it presents certain difficulties.

1. As we saw above, if we wish to obtain a bright image of a source by collecting the maximum possible light from it, the objective lens must be made as large as possible. However, it is very difficult to make very large lenses. Also, large lenses are very heavy and tend to get distorted.
2. As the objective and eyepiece are placed at the opposite ends of the telescope, the length of the telescope also increases with increase in the size of the lenses and the telescope becomes difficult to manage.
3. The images formed by lenses have errors of colours. This is called chromatic aberration.

To overcome these difficulties, telescopes are made using concave mirrors. As light rays get reflected by mirrors in these telescopes, they are called **reflecting telescopes**. In order to get a bright image of a source, large mirrors are necessary (so that they can collect a large amount of light from the source), but it is easier to make large mirrors as compared to making large lenses. Also, big mirrors can be made by combining several smaller pieces. The weight of a large mirror too is less than that of a lens of the same size. The images formed by mirrors do not have errors of colour. Only by using these large telescopes, can we see far away stars and galaxies, which we could never have seen using our naked eyes.

The reflecting telescopes are mainly of two types: Newtonian and Cassegrain. As shown in figure 18.2 light rays coming from space are reflected by the concave mirror. Before these reflected rays converge at the focus, they are deflected again by a small plane mirror. As a result, they get focused at a point lying on the perpendicular to the axis of the telescope's cylinder. They pass through the eyepiece and we get a magnified image of the source.

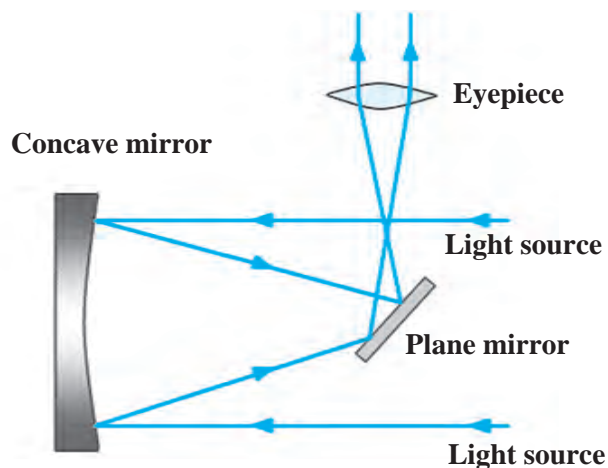

18.2 The Newtonian telescope

The construction of a Cassegrain type of telescope is shown in figure 18.3. The Cassegrain telescope also uses a concave mirror. However, here light rays, after reflection from the concave mirror, are reflected back towards it by a small convex mirror. They pass through a hole at the centre of the concave mirror and then through the eyepiece situated at the back of the mirror. The eyepiece gives us a magnified image of the source.

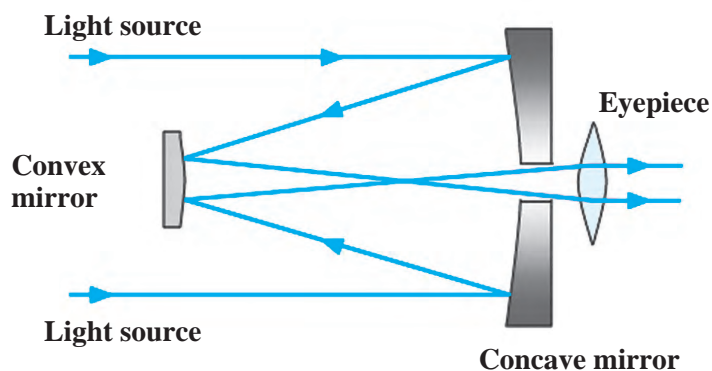

18.3 The Cassegrain telescope

In India, we have several telescopes with concave mirrors of 2 m diameter that have been in use for many years. The biggest optical telescope in India, having a mirror of 3.6 m diameter is situated in the Aryabhata Research Institute of Experimental Sciences, Nainital. This is the largest optical telescope in Asia.

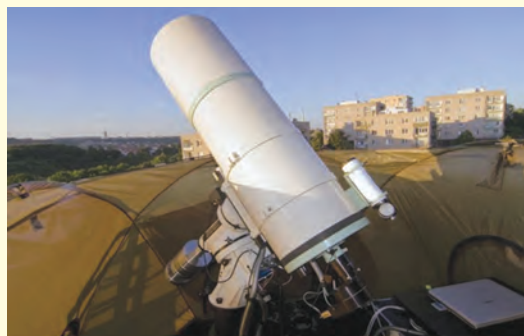

Radio telescope

Many heavenly objects emit radio waves in addition to visible radiation. We cannot see this radiation with our eyes. Hence, a special type of telescope is used to receive these rays. It is called a radio telescope. It is made from one or more dishes of a particular parabolic shape. As in optical telescope the incident radio waves are reflected by these dishes and converge at the focus. A radio receiver is placed at the focal point. The information gathered by this receiver is passed on to a computer which analyses it and constructs an image of the source.

A large radio telescope called the Giant Meterwave Radio Telescope (GMRT) has been erected at Narayangaon near Pune. It uses radio waves having wavelengths of about a metre, coming from planets and stars to study those heavenly bodies. This telescope is actually a collection of 30 dishes, each having a diameter of 45 m. It is called a giant telescope as the arrangement of the 30 dishes over an area which measures up to 25 km across, is made in such a way that it works as a single dish having a diameter of 25 km. This means that the GMRT gives the same data that we would have got from a telescope having a single dish of 25 km diameter! GMRT has been made by Indian scientists and engineers at minimum cost. It is a world standard research facility. Scientists study the solar system, solar winds, pulsars, supernova, interstellar hydrogen clouds, etc. with the help of the GMRT. Scientists from all over the world come to India to make use of this facility.



A

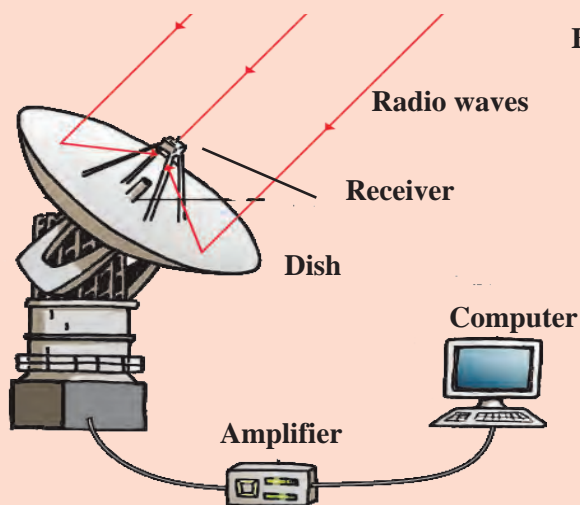

B

18.4 A. Radio telescope (photograph) B. The structure of a radio telescope

Telescopes in space

Visible light and the radio waves emitted by heavenly bodies in space can pass through the earth's atmosphere and reach the earth's surface. So, optical and radio telescopes can be erected on the surface of the earth. However, these earth-based telescopes present some problems in making good quality observations.

The visible light coming from a heavenly body has to pass through the earth's atmosphere to reach the earth's surface. During this journey, some of the light is absorbed by the atmosphere and the intensity of the light reaching the earth's surface decreases. A second problem is caused by the changes in atmospheric pressure and temperature. These changes cause turbulence in the atmosphere which in turn cause of the light rays to change their path slightly and thereby shake the position of the image. Also, because of Sunlight, we cannot use optical telescopes during the day. During the night too city lights and cloudy weather can cause difficulties in observing the heavenly bodies. To reduce these problems, optical telescopes are situated on top of mountains, at in uninhabited places. However, if we want to get rid of all the above problems completely, we should place the telescope above the earth's atmosphere, in space itself. These problems do not exist in the space and thus the image obtained by space telescopes would be bright and very clear and will remain at one place. Scientists have turned this idea into reality.

In 1990, the National Aeronautics and Space Administration launched into space an optical telescope called the **Hubble telescope**. It has a mirror of diameter 94 inches and is orbiting the earth at a height of 589 km from it. This telescope is still working and has helped to make important discoveries.



In 1999, the National Aeronautics and Space Administration launched an X-ray telescope named **Chandra**, in space, to study X-rays coming from heavenly objects. Special mirrors which can reflect X-rays were used in this telescope. Chandra has given us very useful information about stars and galaxies. The telescope is named after the famous Indian scientist Subramanian Chandrashekhkar.



Indian Space Research Organization (ISRO) Bengaluru

This institute was established in 1969 with the aim of developing technology for making and launching of artificial satellites. Till date, ISRO has successfully launched a large number of satellites. ISRO's programme is foremost among the successful programs undertaken by independent India. India's progress in space science has played a big role in national and social development.

The INSAT and GSAT series of satellites support our telecommunication network, television broadcasting and meteorological services. It is because of them that telephone, television and internet services are available everywhere in the country. The EDUSAT satellite in this series is used exclusively for education. The IRS satellite series is used for the monitoring and management of natural resources as well as disaster management.

Website : www.isro.gov.in

Astrosat

In 2015, Indian Space Research Organization (ISRO) launched an artificial satellite called Astrosat, in space. This satellite has ultraviolet and X-ray telescopes and detectors. Most of the parts used in this satellite are made in India. It is a unique system having different kinds of telescopes on a single satellite. Indian scientists are studying various aspects of the Universe using the data obtained with these telescopes.

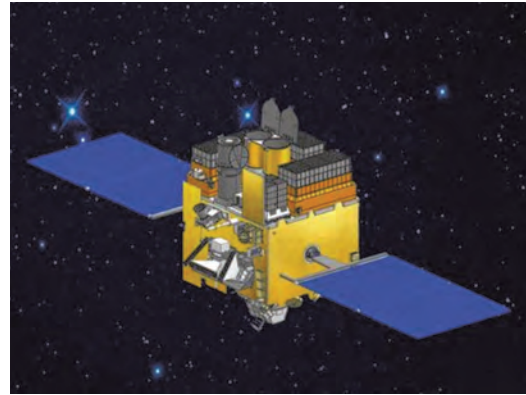

Find out

Collect more information about telescopes that work in space apart from the Hubble and Chandra telescopes.



Exercises

1. Fill in the blanks with the proper words.

- The wavelength of visible light is between and
- GMRT is used for waves.
- A certain X-ray telescope is named after scientist
- The first scientist to use a telescope for space observation was
- The biggest optical telescope in India is situated at

2. Form pairs

- | 'A' Groups | 'B' Groups |
|--------------------------------------|-------------|
| (i) X-rays | (a) GMRT |
| (ii) Optical Telescope | (b) ISRO |
| (iii) Indian radio telescope | (c) Hubble |
| (iv) Launching artificial satellites | (d) Chandra |

3. What are the difficulties in using ground based optical telescopes? How are they overcome?

4. Which type of telescopes can be made using a concave mirror, convex mirror, plane mirror and a lens? Draw diagrams of these telescopes.

5. Study the figure and answer the following questions

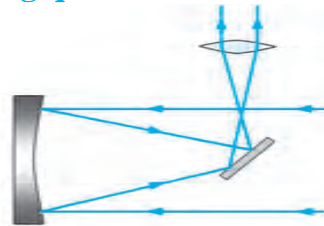

- What type of telescope is shown in the figure?
- Label the main parts of the telescope.
- Which type of mirror does the telescope use?
- What other type of telescope uses a curved mirror?
- Explain the working of the above telescope.

6. Answer the following questions.

- Explain the construction of Galileo's telescope.
- Explain the construction of a radio telescope.
- Why are optical telescopes located in uninhabited places on mountains?
- Why can an X-ray telescope not be based on the earth?

Project : Collect information about various observatories in India and present it in the class.



Science and Technology - Educational Planning

There are altogether eighteen chapters in which the subject of Science and Technology has been covered. Of these, the first ten chapters deal with the topics included in the portion of Paper I and Paper II to be studied the first term. There are two separate papers for the two subjects namely Science and Technology in each term. The sequence of the chapters in the textbook has been planned accordingly. Paper I includes physics and chemistry while Paper II deals with Biology and the rapidly developing and indispensable topics related to Environment, Space, Weather and climate, Disaster management and Information communication technology all of which have a great impact on all our lives.

Even though, in both terms, the subject has been separated into Paper I (physics and chemistry) and Paper II (biology and other Science-related subjects such as environment, space, weather and climate, disaster management and information communication technology), teachers must adopt an integrated approach and consistently teach with that attitude. Some important points which teachers may keep in mind for the purpose of making annual plans are given below.

Term-wise plan of chapters

First Term

	Part I		Part II
Chapter No.	Name of chapter	Chapter No.	Name of chapter
1	Laws of Motion	6	Classification of plants.
2	Work and Energy	7	Energy Flow in an Ecosystem
3	Current Electricity	8	Useful and Harmful Micro-organisms
4	Measurement of matter	9	Environmental Management
5	Acids Bases and Salts	10	Information Communication Technology (ICT) : The new direction of progress

Second Term

	Part I		Part II
Chapter No.	Name of chapter	Chapter No.	Name of chapter
11	Reflection of Light	15	Life Processes in Living Organisms
12	Study of Sound	16	Heredity and Variation
13	Carbon : An important element	17	Introduction to Biotechnology
14	Substances in Common Use	18	Observing Space.....Telescopes

1. Practical work, written exams and all information about it will be given separately.
2. While doing practical work, along with the given experiments, the various activities given in the textbook must also be done.
3. A record of practical work done should be organized under the heads Title, Apparatus/Materials/ Chemicals, Diagram, Procedure, Observations, Inference/Conclusion.
4. As the questions given at the end of each lesson are based on the content of the lesson as well as the various activities and projects, a deliberate effort will have to be made to guide the students to the expected answers.
5. Several of the given activities are newly included in our textbooks and each of them should be completed separately. The report of the activity should be written in the following order : Preface, Need/ Necessity, Methodology, Observations, Inferences and Conclusion.

Practical Notebook for Standard Nine

Practical Notebook Cum Journal - Science and Technology

**English
Medium**

**Price
₹ 35.00**

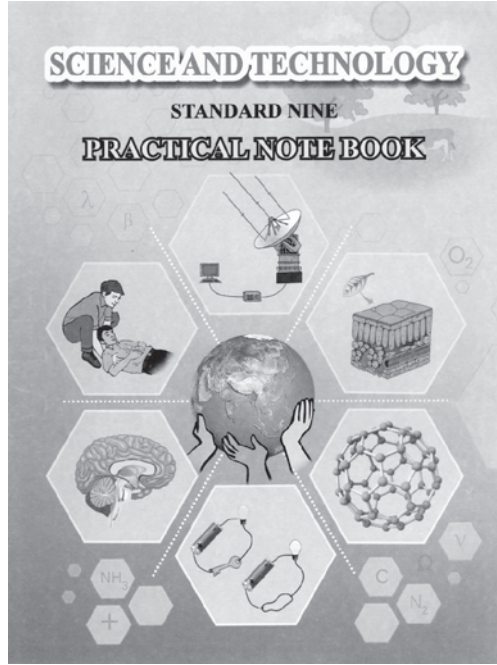

- Based on Government approved syllabus and textbook
- Inclusion of practicals based on all chapters as per Evaluation scheme.
- With full of various activities, pictures, figures/ diagrams, etc.
- Inclusion of objective/multiple choice questions
- Inclusion of useful questions for oral examination
- More questions for practice and separate space for writing answers

Practical notebooks are available for sale in the regional depots of the Textbook Bureau.

(1) Maharashtra State Textbook Stores and Distribution Centre, Senapati Bapat Marg, Pune 411004 ☎ 25659465
(2) Maharashtra State Textbook Stores and Distribution Centre, P-41, Industrial Estate, Mumbai - Bengaluru Highway, Opposite Sakal Office, Kolhapur 416122 ☎ 2468576 (3) Maharashtra State Textbook Stores and Distribution Centre, 10, Udyog Nagar, S. V. Road, Goregaon (West), Mumbai 400062 ☎ 28771842
(4) Maharashtra State Textbook Stores and Distribution Centre, CIDCO, Plot no. 14, W-Sector 12, Wavanja Road, New Panvel, Dist. Rajgad, Panvel 410206 ☎ 274626465 (5) Maharashtra State Textbook Stores and Distribution Centre, Near Lekhanagar, Plot no. 24, 'MAGH' Sector, CIDCO, New Mumbai-Agra Road, Nashik 422009 ☎ 2391511 (6) Maharashtra State Textbook Stores and Distribution Centre, M.I.D.C. Shed no. 2 and 3, Near Railway Station, Aurangabad 431001 ☎ 2332171 (7) Maharashtra State Textbook Stores and Distribution Centre, Opposite Rabindranath Tagore Science College, Maharaj Baug Road, Nagpur 440001 ☎ 2547716/2523078 (8) Maharashtra State Textbook Stores and Distribution Centre, Plot no. F-91, M.I.D.C., Latur 413531 ☎ 220930 (9) Maharashtra State Textbook Stores and Distribution Centre, Shakuntal Colony, Behind V.M.V. College, Amravati 444604 ☎ 2530965



ebalbharati

E-learning material (Audio-Visual) for Standards One to Twelve is available through Textbook Bureau, Balbharati...

- Register your demand by scanning the Q.R. Code given alongside.
- Register your demand for E-learning material by using Google play store and downloading ebalbharati app.
www.ebalbharati.in, www.balbharati.in



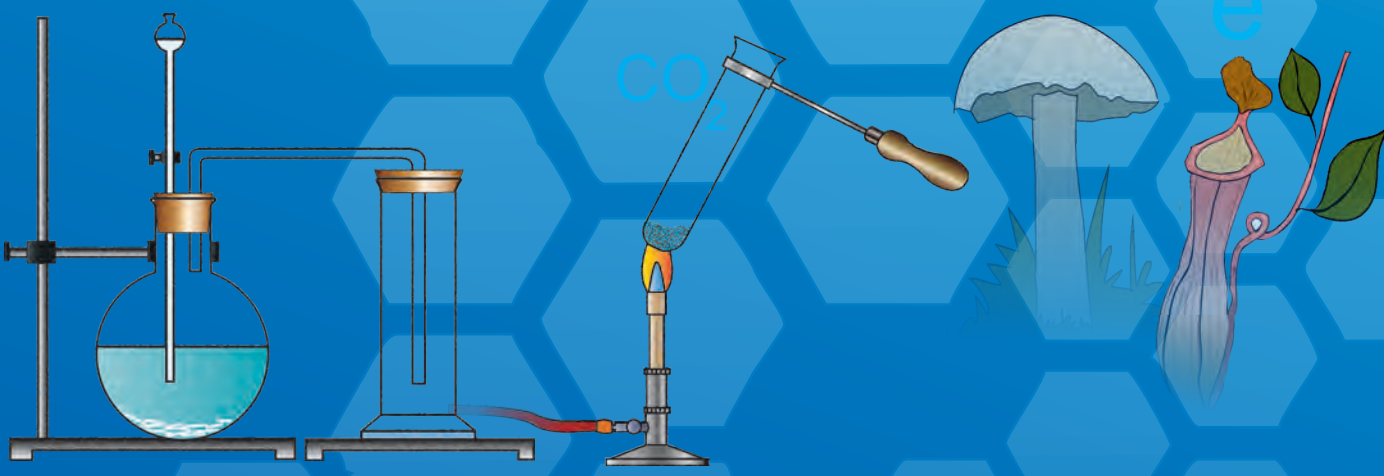
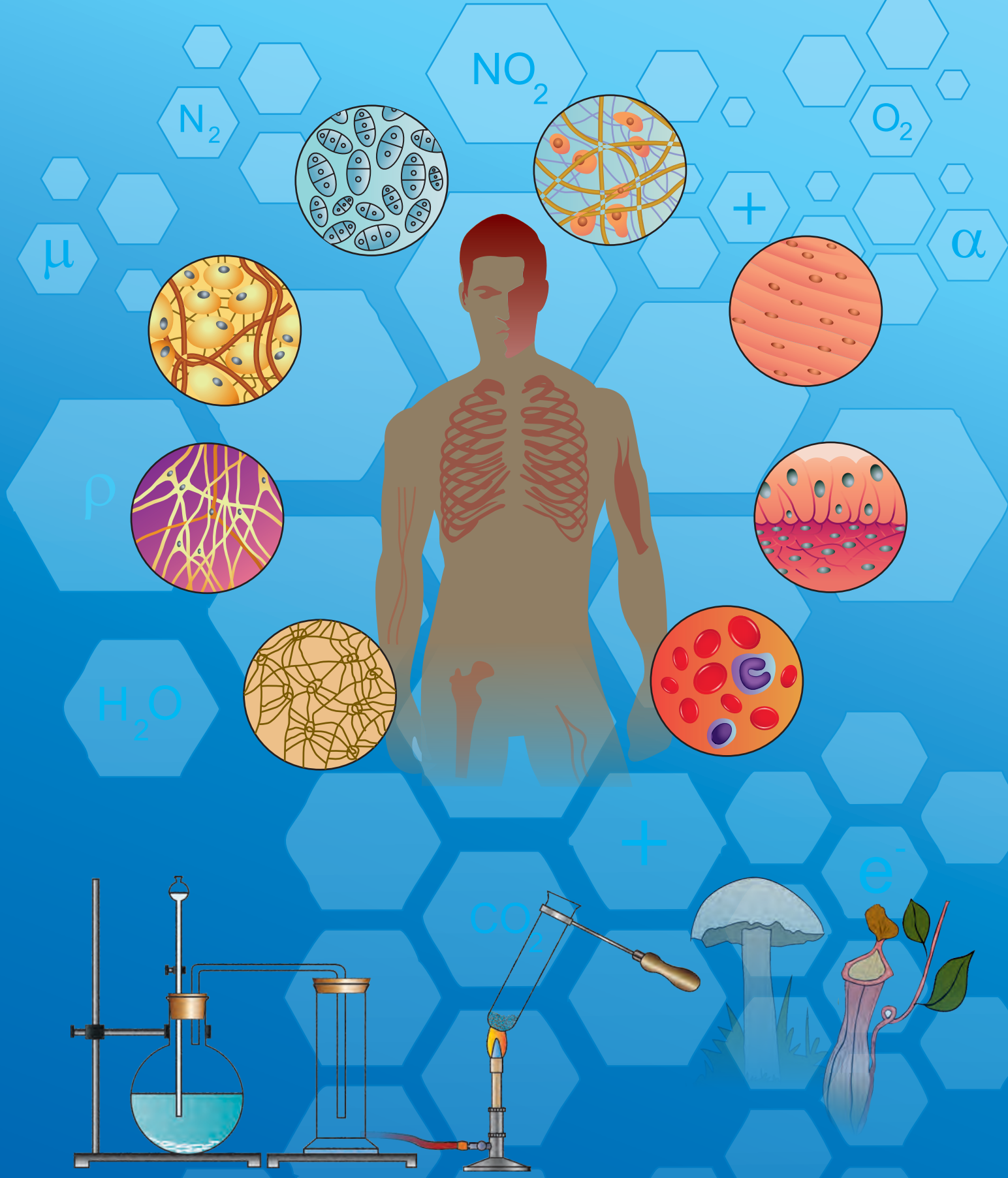

MAHARASHTRA STATE BUREAU OF TEXTBOOK PRODUCTION AND CURRICULUM RESEARCH, PUNE.

विज्ञान आणि तंत्रज्ञान इयत्ता नववी (इंग्रजी माध्यम)

₹ 107.00